

Catalog
1989-90



**Okaloosa-Walton
Community College**

"Okaloosa-Walton Community College is dedicated to the concepts of equity and equal opportunity. It is the specific intention of the college not to discriminate on the basis of age, color, creed, handicap, marital status, national origin, race, religion, or sex in its employment practices or in the admission and treatment of students."

OKALOOSA-WALTON COMMUNITY COLLEGE

ACCREDITED BY

SOUTHERN ASSOCIATION OF COLLEGES
AND SCHOOLS

FLORIDA STATE DEPARTMENT OF EDUCATION

MEMBER

AMERICAN ASSOCIATION OF COMMUNITY
JUNIOR COLLEGES

SOUTHERN ASSOCIATION OF JUNIOR COLLEGES

FLORIDA COMMUNITY COLLEGE ACTIVITIES
ASSOCIATION

FLORIDA ASSOCIATION OF COMMUNITY COLLEGES

OKALOOSA-WALTON COMMUNITY COLLEGE
DISTRICT BOARD OF TRUSTEES

Eileen H. Arpke

Hilda R. Coursey

John E. Baldwin

Charlie H. Hill

Elise D. Biggs

C. Jeffrey McInnis

Patrick E. Byrne, II

Jean H. Wilkinson

James R. (Bob) Richburg
President and Corporate Secretary

TABLE OF CONTENTS

COLLEGE CALENDAR	vii-ix
GENERAL INFORMATION	1
Campus Life	3
Composition of Student Body	4
Equal Rights	4
Facilities	2
Goals	1
History	1
OWCC Alumni Association	3
OWCC Foundation	3
Protection of Privacy	4
Purpose Statement	1
Self-Study Accreditation	4
Year-Round Opportunity	4
ADMISSIONS	5
Adult Basic Education	7
College-Credit Admission Requirements	5
Conditional Enrollment	10
Controlled Admissions	10
Enrollment of Foreign Students	9
Enrollment of Non-Degree-Seeking Students	6
Florida Criminal Justice Training Center Number 21, OWCC	10
General Information	5
High School Released-Time Program	7
Lifelong Learning	7
Non-College-Credit Admission Requirements	7
Provisional Enrollment	7
Special Enrollments	7
Special Enrollments for High School Students	8
FINANCE	12
Dishonored Check Policy	13
Fee Changes	14
Fines, Penalties and Indebtedness	14
Fee Schedule	14
Financial Assistance	12
General	12
Military Assistance	12
Refund Policy	12
Refund Policy for College Credit Courses	13
Refund Policy for Non-Credit Courses	13
Residency Classification	12
Student Loans	13
Veteran's Benefits and Assistance	12
STUDENT SERVICES	15
Academic Assistance	15
Governance	15
Career Planning Assistance	15
Health Services	16
Job Placement Service	16
Orientation	16
Rules and Regulations	17
Services to Students with Special Needs	17
Standardized Testing	17
Student Athletics	17
Student Conduct	18
Student Grievance	18
Student Organizations	19

FINANCIAL AID	20
Additional Information and Requirements	25
College Costs	20
Contracted Services by Students	26
Deadlines for Applying for Financial Aid at OWCC	21
Eligibility	22
Enrollment Status	22
Financial Aid Administered by OWCC	28
Full-Time Student	22
Policies and Procedures	22
Procedures for Applying for Financial Aid	20
Purpose of OWCC's Financial Aid Program	20
Standards of Progress for Federal Financial Aid Eligibility	24
Student Financial Aid	20
Transfer Students	21
Veteran's Benefits	27
INSTRUCTIONAL PROGRAMS	30
Academic Advising	39
Academic Standing	32
Audit Status	30
Change of Schedule	30
Class Attendance	31
College Level Academic Skills Test	34
Credit by Alternative Means	35
Credits For Armed Services	38
Examinations and Grades	31
Full-Time and Part-Time Status	30
Incomplete Grades	31
Non-Punitive Grades	31
Requirements for Graduation	35
Satisfactory/Unsatisfactory Grades	32
Servicemember's Opportunity College	38
Special Comments Concerning English and Reading	40
Special Comments Concerning Mathematics	41
Special Comments Concerning Nursing	42
Subject Examinations	38
Transferring to a Senior Institution	38
Veterans' Educational Benefits	39
Veterans' Fee Deferment Policy	39
Withdrawals	32
PROGRAMS	42
Associate of Arts	42
Associate of Science	54
Associate of Science/Applied Science Options Program Requirements	62
Occupational Certificate	69
ADULT GENERAL AND CONTINUING EDUCATION	74
Adult Basic Education	74
College Preparatory	74
General Education Development and Adult High School Diploma	74
Vocational Preparatory	74
FLORIDA'S STATEWIDE COURSE NUMBERING SYSTEM	75
Authority For Acceptance of Equivalent Courses	77
Equivalency Sequences	76
Exceptions to the Rule For Equivalencies	77
Explanation of Prefixes and Numbers	76
First Digit	75
General Rule for Course Equivalencies	75
Lab Indicators	76
Titles	75
COURSE OFFERINGS	78
COURSE DESCRIPTIONS	79
PERSONNEL	117
LOCATION OF COURSES BY DEPARTMENT	126

Okaloosa-Walton Community College

OWCC TELEPHONE NUMBERS

CENTERS	NUMBERS
Main Campus (Niceville)	678-5111
	892-5145
	682-5272
Fort Walton Beach	244-1000
DeFuniak Springs	892-2174
Eglin AFB	678-3727
Hurlburt Field	581-3006

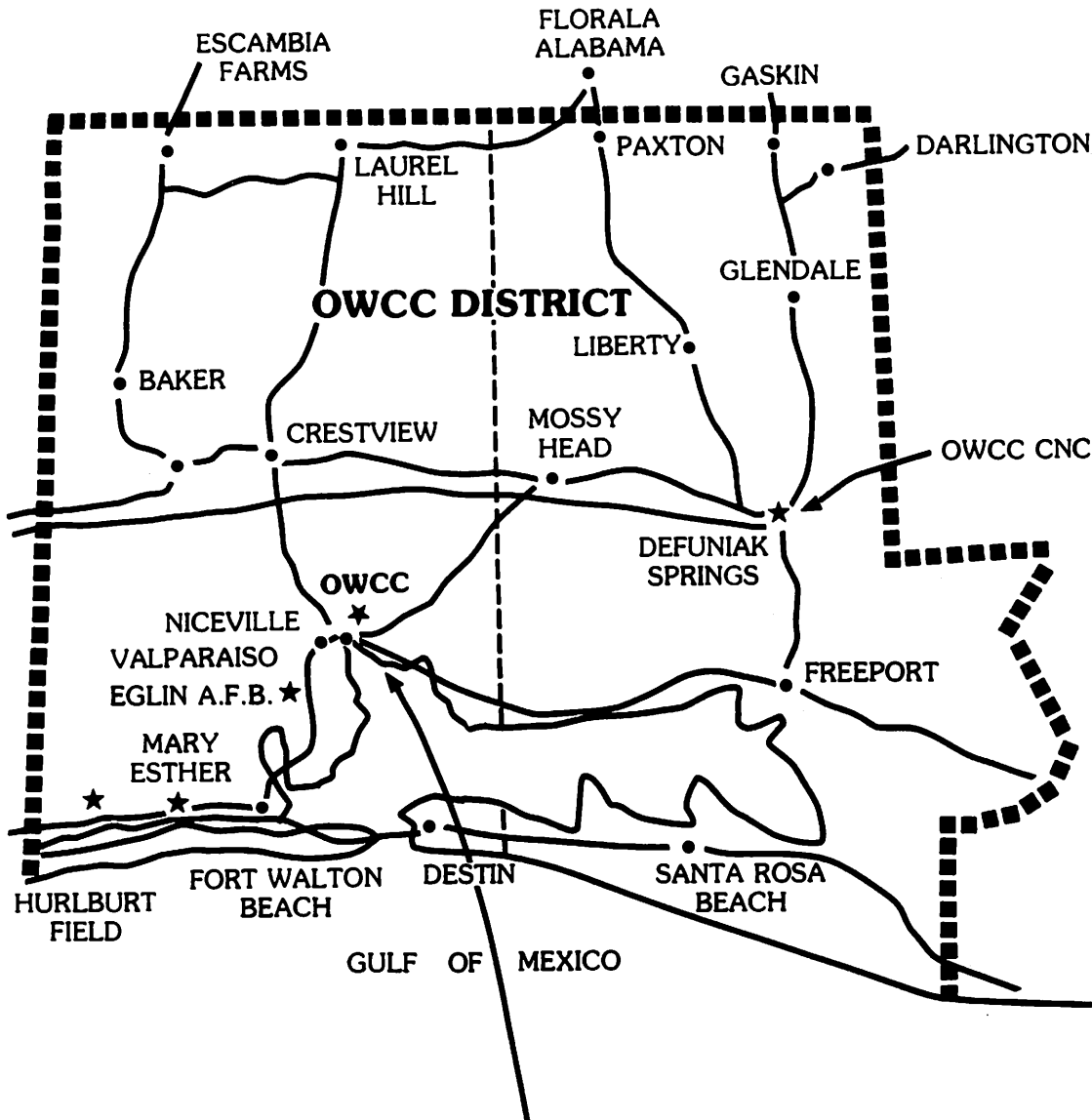
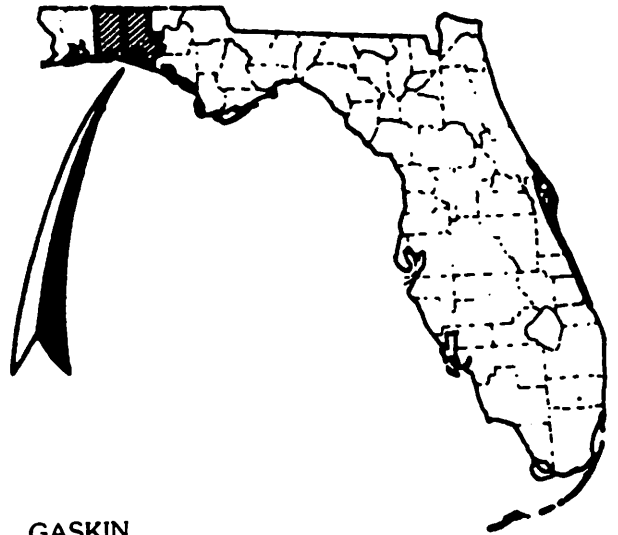

Okaloosa-Walton Community College
 100 College Boulevard
 Niceville, Florida 32578

1989

1990

JANUARY							IMPORTANT DATES							JULY						
S	M	T	W	T	F	S								S	M	T	W	T	F	S
1	2	3	4	5	6	7	JANUARY							2	3	4	5	6	7	8
8	9	10	11	12	13	14	1 New Year's Day							9	10	11	12	13	14	15
15	16	17	18	19	20	21	16 Martin Luther King, Jr. Day							16	17	18	19	20	21	22
22	23	24	25	26	27	28	FEBRUARY							23	24	25	26	27	28	29
29	30	31	8 Ash Wednesday							AUGUST							30	31		
FEBRUARY							MARCH							SEPTEMBER						
S	M	T	W	T	F	S	S	M	T	W	T	F	S	S	M	T	W	T	F	S
1	2	3	4	5	6	7	1	2	3	4	5	6	7	1	2	3	4	5	6	7
8	9	10	11	12	13	14	8	9	10	11	12	13	14	8	9	10	11	12	13	14
15	16	17	18	19	20	21	15	16	17	18	19	20	21	15	16	17	18	19	20	21
22	23	24	25	26	27	28	22	23	24	25	26	27	28	22	23	24	25	26	27	28
29	30	31	29	30	31	29	30	31												

JANUARY							IMPORTANT DATES							JULY						
S	M	T	W	T	F	S								S	M	T	W	T	F	S
1	2	3	4	5	6	7	JANUARY							8	9	10	11	12	13	14
8	9	10	11	12	13	14	1 New Year's Day							15	16	17	18	19	20	21
15	16	17	18	19	20	21	15 Martin Luther King, Jr. Day							22	23	24	25	26	27	28
22	23	24	25	26	27	28	FEBRUARY							29	30	31				
29	30	31	12 Lincoln's Birthday							AUGUST							30	31		
FEBRUARY							MARCH							SEPTEMBER						
S	M	T	W	T	F	S	S	M	T	W	T	F	S	S	M	T	W	T	F	S
1	2	3	4	5	6	7	1	2	3	4	5	6	7	1	2	3	4	5	6	7
8	9	10	11	12	13	14	8	9	10	11	12	13	14	8	9	10	11	12	13	14
15	16	17	18	19	20	21	15	16	17	18	19	20	21	15	16	17	18	19	20	21
22	23	24	25	26	27	28	22	23	24	25	26	27	28	22	23	24	25	26	27	28
29	30	31	29	30	31	29	30	31												



BOARD CHAIRWOMAN Hilda Coursey, center, helps the Student Government Association dip ice cream in the College Mall.

CALENDAR OF INSTRUCTIONAL ACTIVITIES

The official Community College Academic Year extends from the beginning of Summer Semester of one calendar year to the end of the Spring Semester of the the following calendar year.

ACADEMIC YEAR 1989-90

FALL SEMESTER, 1989

Off-Campus Registration (by announcement)	July-August
Early Registration opportunities for previously and currently enrolled OWCC students (all locations)	July 24-28
New Student Program Planning and Early Registration (by invitation)	July 25-28
Walk-In Registration at All College Locations	July 31 - August 14
In-Service Workshops (Faculty returns 8:30 a.m. August 15)	August 15-17
Registration for Returning Students	August 18-21
Program Planning and Registration for New Students (times by announcement)	August 18-21
Cancellation of classes with insufficient enrollments (end of day)	August 21
Late Registration and last days to add courses	August 23-31
Class Days:	
College-Credit and Non-College Credit Classes (including final examinations for semester-length classes)	August 23-December 14
Last day to pay fees or to receive any refund of fees for full term courses	August 31
CLAST Registration Deadline	September 8
Graduation application deadline for Fall Semester (all programs)	September 8
College Closed	September 4
College Level Academic Skills Test	October 7
Mid-Term Grades due in Registrar's Office by 3:30 p.m.	October 16
Last day to drop a course with a grade of "W" or to change to "Audit" status:	
Term-length course by 5:00 p.m.	October 25
Courses meeting less than full term	Mid-point + 3 days
College Closed	Nov. 10
College Closed	Nov. 23-24
(Note: Saturday classes will not meet on November 25)	
Early Registration opportunities for Spring Semester for previously and currently enrolled OWCC students (by announcement)	December 4-8
Early Registration opportunities for Spring Semester for new students (by invitation)	December 7-8
Final Examination (college-credit courses) (Note: Final examinations for Saturday classes will be given on Saturday, December 9)	December 12-14
Walk-in Registration	December 11-14
Final Grades due in Registrar's Office (12 Noon)	December 15
Campus Closed	December 18-January 1

SPRING SEMESTER, 1990

Faculty Returns (9 a.m.)	January 2
Registration for Returning Students (times by announcement)	January 3-4
Program Planning and Registration for New Students (times by announcement)	January 3-4
Cancellation of classes with insufficient enrollment (at end of day)	January 4
Late Registration and last day to add courses	January 8-16
Class Days:	
College-Credit and Non-College-Credit Classes (including final examinations for semester-length classes)	January 8-May 1

Last day to pay fees or to receive any refund of fees for full term courses	January 16
College Closed	January 15
Graduation application deadline for Spring Semester (all programs) at 4:30 p.m.	February 9
CLAST Registration Deadline	February 9
College Closed	February 19
Mid-Term grades due in Registrar's Office by 12 noon	March 1
College Level Academic Skills Test	March 10
Last day to drop a course with a grade of "W" or to change to "Audit" status:	
Term-length course	March 9
Course meeting less than full term	Mid-point + 3 days
College Closed (Note: Saturday classes will not meet on April 14)	April 12-13
Early Registration opportunities for Summer Semester for previously and currently enrolled OWCC students (by announcement)	April 23-26
Early Registration opportunities for Summer Semester for New Students (by invitation)	April 25-26
Final Examination (college-credit courses) (Note: Final examinations for Saturday classes will be given on Saturday, April 28)	April 27-May 1
Final Grades due in Registrar's Office (12 noon)	May 2
Graduation	May 4

SUMMER SEMESTER (May, 1990 - July, 1990)

TWELVE-WEEK SUMMER SEMESTER, 1990

General Registration for all students	May 7
CLAST Registration Deadline	May 4
Graduation application deadline for Summer Semester (all programs)	May 4
Cancellation of classes with insufficient enrollment (end of day)	May 7
Late Registration and last day to add courses	May 9-16
Class Days:	
College-Credit and Non-College-Credit Classes	May 9-August 2
Last day to pay fees or to receive any refund of fees for full-time courses	May 16
College Closed	May 28
College Level Academic Skills Test	June 2
Mid-Term Grades due	June 20
Last day to drop a course with a grade of "W" or to change to "Audit" status:	
Term-length course	June 28
Course meeting less than full term	Mid-point + 3 days
College Closed	July 4
Late graduation application deadline for those who have taken CLAST and have not applied for graduation	July 9
Final Grades due in Registrar's Office (4 p.m.)	August 3

SUMMER SEMESTER, 1990

TERM I, FIRST SIX WEEKS SUMMER SESSION (May 9 - June 20)

General Registration for all Students	May 7
CLAST Registration Deadline	May 4
Cancellation of classes with insufficient enrollment (at end of day)	May 7
Late Registration and last day to add courses	May 9-14
Class Days:	
College-Credit and Non-College-Credit Classes	May 9-June 20
Last day to pay fees or to receive any refund of fees for full-term courses	May 14
College Closed	May 28
Last day to drop a course with a grade of "W" or to change to "Audit" status:	
Term-length courses	June 4
Courses meeting less than full term	Mid-point + 3 days
College Level Academic Skills Test	June 2
Final Grades due in Registrar's Office (4:00 p.m.)	June 21

SUMMER SEMESTER, 1990

TERM II, SECOND SIX WEEKS SUMMER SESSION (June 21 - August 2)

Registration for Returning Students (times by announcement)	June 18-19
Program Planning and Registration for New Students (times by announcement)	June 18-19
Cancellation of classes with insufficient enrollment (at end of day)	June 19
Class Days:	
College-Credit and Non-Credit Classes	June 21-August 2
Late Registration and last day to add courses	June 21-26
Last day to pay fees or to receive any refund of fees for full-term courses	June 26
College Closed	July 4
Late graduation application deadline for those who have taken CLAST and have not applied for graduation	July 9
Last day to drop a course with a grade of "W" or to change to "Audit" status:	
Term-length courses	July 17
Course meeting less than full-term	Mid-point + 3 days
Final Grades due in Registrar's Office (4 p.m.)	August 3



LOCAL ARTIST, Carol Hawkins, describes the symbolism in her watercolor prepared in observance of the college's 25th Anniversary celebration. Jeff McInnis, Board Member, served as introducer to the unveiling at the 25th Anniversary kickoff, January 25, 1989.



GUEST HAPIST Marjorie Tyre visited the campus to play in Oratorio de Noel with the Northwest Florida Symphony Orchestra. She appeared in the College Mall in a solo performance and to explain the role of the harp in music.

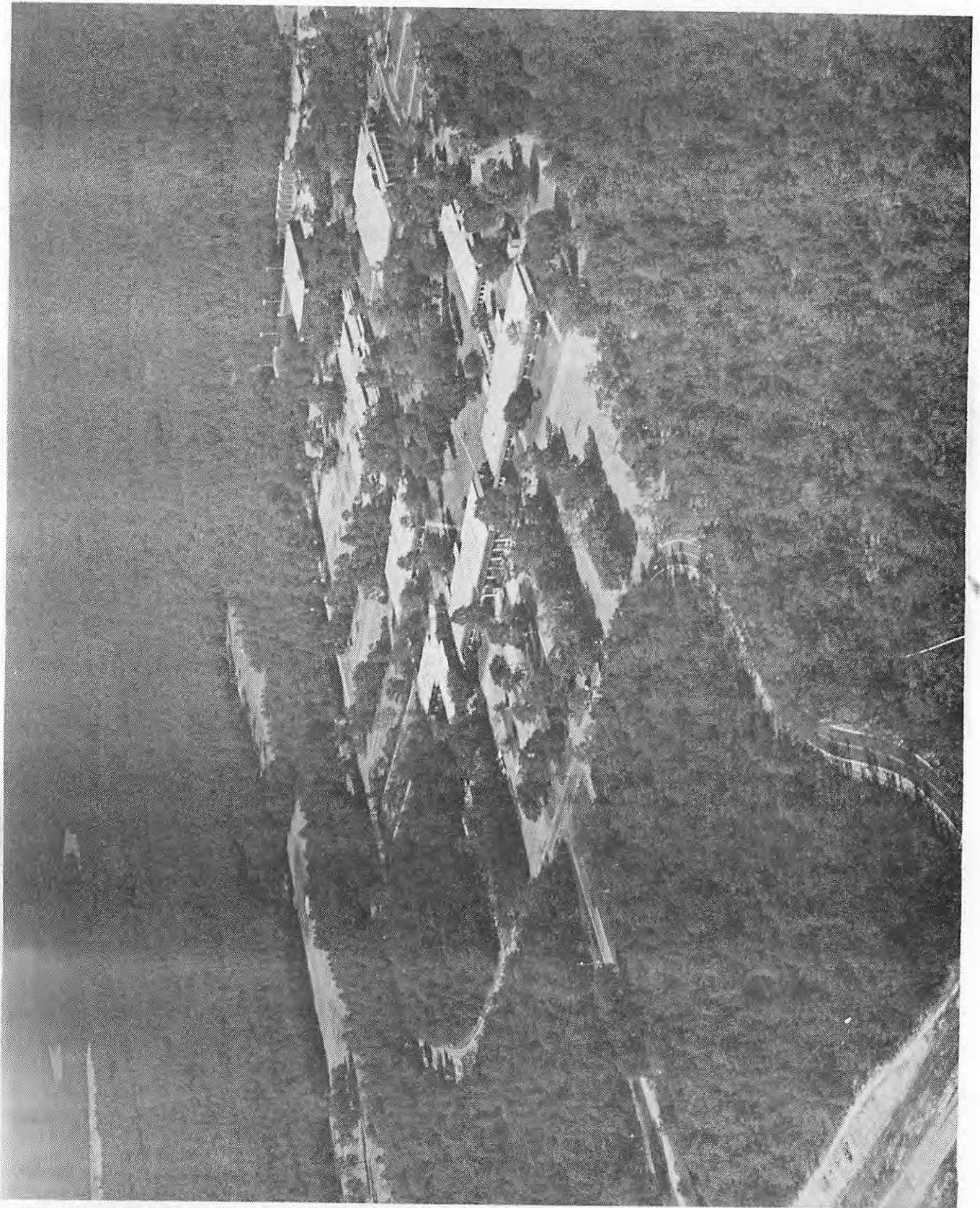

THE COLLEGE as Okaloosa-Walton Community College looked from the air in the summer of 1988.

GENERAL INFORMATION

PURPOSE STATEMENT

Okaloosa-Walton Community College is committed to quality educational programs and services providing the opportunity for students to achieve their goals and for satisfying community needs. To this end, the college seeks to help improve the quality of life by offering excellence in academic, occupational, cultural, economic, and personal development programs.

GOALS

To provide a college environment that promotes equity and access to college programs for all citizens.

To provide student and community services and activities that enhance the quality of educational life.

To provide freshman and sophomore courses leading to baccalaureate degrees.

To provide two-year degrees that prepare students for careers in the public and private sectors.

To provide support to the economic development of Okaloosa and Walton counties.

To provide adult literacy programs, including adult basic education, General Education Development (GED) preparation, and vocational preparatory instruction.

To provide social and cultural enrichment opportunities in Okaloosa and Walton counties.

To provide a variety of opportunities for continuing education.

To provide preparatory instruction in basic skills.



RETIRING THE SEAL. Dr. J. E. McCracken, founding president, accepts the college seal that graced the front of the building which is being replaced by one that says "community college" rather than "junior college."

HISTORY

Twenty-five years of service and outstanding accomplishments is, in brief, the history of OKALOOSA-WALTON COMMUNITY COLLEGE! From the earliest days of its activation, OWCC has been in operation as the college for Okaloosa and Walton counties. OWCC serves approximately 10,000 persons annually. In this twenty-five years it has served more than 100,000 persons; a consistent record of education for excellence through the success of students transferring to senior institutions; received many acknowledgements and recognition, including a citation by the President of the United States of America in 1972. In 1984, the College received the coveted "Secretary's Award" from the U.S. Secretary of Education for its Drafting and Design Technology program for Region IV.

Initial founding and funding took place on April 16, 1963, by action of the State Legislature. In prompt succession the initial Advisory Committee, now the District Board of Trustees, was appointed (December 1963); the first President employed (February 15, 1964); the College named (March 3, 1964); its temporary location established (April 3, 1964); its faculty employed (August 17, 1964); and its first classes begun on a beautiful morning (August 24, 1964) on the quaint, temporary campus in Valparaiso, Florida.

The temporary size of approximately twelve acres was centered around Perrine Park in Valparaiso. The Twin Cities of Niceville and Valparaiso, Florida, contributed to the initial conversion of the park and buildings into a collegiate campus. The campus consisted of seven buildings at the time of its opening session August, 1964. The facilities had increased to twenty-three buildings to accommodate the broader range of programs and the greatly expanded student enrollment by the fall of 1968.

The permanent site of the present campus is located at the northern boundary of Niceville between State Road 85 and State Road 285 in a beautiful wooded area. It was designated on November 24, 1965. Transfer of 264 acres of land from the Eglin Air Force Reservation was made by an Act of Congress in January, 1966, to Okaloosa-Walton Community College.

Ceremonies dedicating the permanent site were held April 10, 1969. These ceremonies included establishing the Robert L.F. Sikes Honorary Faculty Chair in Government, the Emil Holzhauer Honorary Faculty Chair in Arts, and the acceptance of the Emil Holzhauer collection of paintings for perpetual care by the OWCC Library.

The philosophy which undergirded the planning of the permanent facility, as summarized by OWCC Charter President, Dr. J.E. McCracken, states "We envision . . . through our program, a movement that will enable an individual to experience all aspects of our great heritage — from arts to sciences; from chemical creativity to technical productivity; from contemplation to primeval origins to consideration of ultimate destinies."

FACILITIES

The Niceville campus of Okaloosa-Walton Community College has been cited as an outstanding example of a much-needed return to human dimensions in college environments. It was occupied in January of 1969. The warm, inviting profiles of the buildings and their natural setting confirm a central commitment of the college — "No one a stranger; a stranger to no one".

The main campus includes the following permanent facilities:

Building A — Administration: houses the executive and administrative offices, including instructional services, administrative and financial services, information services, and the office of the College Foundation.

Building B — Technical Education Laboratory: contains electronics, drafting and design, and computer-assisted drafting laboratories.

Building C1 — Student Services Center: houses admissions, registration, counseling, financial aid advisement services, and Career Information Center.

Building C2 — Business Education Building: provides facilities for instructional programs in business education, business administration, secretarial science, word processing, and mid-management.

Building E — The Learning Resources Center: located on the three center floors and the south mezzanine of building E. It contains a collection of more than 74,000 books and subscribes to 610 magazines and 22 newspapers.

The Audio-Visual collection has over 49,000 items including: 6,550 recordings, 3,157 tape cassettes, 22,661 slide sets, and 727 videocassettes.

Faculty offices, classrooms and Graphic Services are on the first floor mezzanine.

Upper mezzanine levels house the Writing Laboratory and faculty offices, study carrels, and the Periodical-Reserve Books Department.

Buildings F&H — Physical Education and Auditorium Complex: a multi-purpose facility used to house all indoor physical education activities and indoor sports events, as well as serving as a center for convocations, theatrical productions, and community cultural events. This complex contains offices, classrooms, and storage facilities for the physical education department, and houses a recently completed Wellness Center. Extensive outdoor facilities provide activity programs for intramural and extramural sports participation.

Buildings G & G1 — Utilities and Maintenance Facilities: houses the air conditioning and heating equipment, central services, maintenance, custodial and ground functions.

Building K — College Mall: contains student activities, food services, bookstore, lounges, meeting rooms, recreational areas, instructional programs in music, humanities, and art.

Building L — Mathematics/Public Service Facility: provides offices, classrooms, and specialized laboratories for the mathematics department and facilities, including a crime scene room and forensics photo lab, for programs offered by the Florida Criminal Justice Training Center No. 21.

Building M — Industrial Education Laboratory: houses the air conditioning, heating, and refrigeration instructional programs.

Building P — Specialized Consumer Services Building: contains classrooms and laboratories for consumer and home economics education, continuing education, adult education, and a Title XX Child Care Center.

Building Q — Industrial Education "Heavy Shops" Building: houses shops and classrooms for the automotive and welding programs.

Building R — Data Processing/Management Information Services Building: provides laboratories and related instructional facilities for the computer science program. The College's Management Information Systems staff is located in this facility.

The College functions at many off-campus locations, bringing services and programs closer to those who may have difficulty reaching the main campus in Niceville:

Building N — The OWCC Chautauqua Neighborhood Center: located in DeFuniak Springs, Fla., this multi-purpose community service facility was constructed through a Housing and Urban Development grant matched by donated funds from Walton County. Diversified non-credit programs and credit courses are offered in this facility, as are services to those with special needs. The Center houses a Title XX Child Care Center.



FILLED TO CAPACITY, OWCC's Chautauqua Neighborhood Center, in DeFuniak Springs has experienced steady growth and now operates at full capacity.

Military Sites, including the Eglin Center, the Hurlburt Center, Duke Field and the Army Ranger Camp: postsecondary programs are offered at these locations, with special programs and services designed for active duty military personnel, civil service personnel, contract personnel, and for the general citizenry on a space available basis.

The Okaloosa-Walton Community College and the University of West Florida Fort Walton Beach Center: provides postsecondary education, adult general education, undergraduate programs, and graduate school programming through a 2+2 arrangement between the two institutions. Temporarily located in leased facilities, a site for permanent facilities has been acquired through a unique exchange of properties by the United States Air Force and the U.S. Dept. of Forestry. Construction on this site, which is located near Hurlburt Field, is expected to begin in late 1989 and be completed by the fall of 1990.

OWCC FOUNDATION

The Okaloosa-Walton Community College Foundation is established to provide scholarships and support for programs and activities which enhance the quality of education for OWCC students and to expand the educational and cultural opportunities for the communities the college serves.

Authorized by the College's District Board of Trustees in January 1988, the OWCC Foundation has a 23-member board. Five board members comprise the Foundation's Executive Committee and administer the organization's activities along with the Foundation's executive director.

A chartered, non-profit organization under Internal Revenue Service (IRS) regulations, the OWCC Foundation is empowered to solicit and receive gifts — whether money or other tangible assets — from individuals, organizations, corporations, and other sources.

The OWCC Foundation has identified certain categories for support. These include: the Scholarship Fund; the Library/Learning Resources Fund; the Personnel and Curriculum Development Fund; the Fine and Performing Arts Fund; and the Endowment Fund.

The OWCC Foundation operates under a philosophy of building principal and using the interest to support the various funds. Endowment building is assisted by a state matching program called the Florida Academic Improvement Trust fund which enables many gifts to be matched on a 60/40 basis. No portion of donations is used for administrative purposes. A Foundation President's Club has been created whereby a \$50 annual pledge helps underwrite operational expenses.

For further information contact the OWCC Foundation Office at (904) 678-5111.

OWCC ALUMNI ASSOCIATION

The Okaloosa-Walton Community College Alumni Association provides all former students and graduates

with an organization to promote the interests of OWCC, support causes which enhance educational opportunities and perpetuate friendships made while attending OWCC.

Membership in the OWCC Alumni Association is open to all graduates of the college and to any OWCC student who has earned at least 30 semester hours of credit.

The alumni association, in cooperation with the college, participates in various activities, sponsors events and encourages creation of OWCC Alumni chapters at senior institutions. The association endeavors to provide resources to assist in scholarships and other program support beneficial to OWCC.

For additional information about the OWCC Alumni Association contact the OWCC Foundation and Alumni office at (904) 678-5111.

CAMPUS LIFE

The atmosphere at OWCC is determined by the blend of dedicated college staff and faculty interacting with a talented, ambitious, determined, and stimulating student body. From this environment comes an unforgettable chain of memorable experiences for college personnel and students. Every student and member of the OWCC organization finds appreciation for each person's nature and for the unique contributions each makes in building and enriching the college.

Students find outlets for particular talents through campus government, sports, interest groups, and many other student activities that complement the central function and purpose of the college — the program of current and continuing studies.



THE PLACE, the College Mall, where everybody meets to study, exchange information, and eat.

YEAR-ROUND OPPORTUNITY

The college's programs of continuing study vary considerably in their timing. Enrichment programs, workshops, institutes, and numerous community services and certificate programs are offered on demand as sufficient requests occur. Special programs are announced as they are developed. The public is especially **invited to request short or extended offerings** in areas of need or interest. These can be provided as long as 12 or more adults are involved.

COMPOSITION OF STUDENT BODY

Okaloosa-Walton Community College is a co-educational institution serving approximately 10,000 students annually of all ages who are legally out of high school.

SELF-STUDY ACCREDITATION

Accreditation by the Florida State Department of Education was granted when the College opened in the fall of 1964. The college attained its full accreditation status in the Southern Association of Colleges and Schools in December 1965. The most recent affirmation of full accreditation by the association was December, 1981.

EQUAL RIGHTS

Okaloosa-Walton Community College is dedicated to the concepts of equity and equal opportunity. It is the specific intention of the college not to discriminate on the basis of age, color, creed, handicap, marital status, national origin, race, religion, or sex in its employment practices or in the admission and treatment of students. The OWCC Equity Coordinator may be contacted through the Office of the Director of Personnel, Niceville campus, extension 213 or 214. The Coordinator is designated to coordinate compliance with the Florida Educational Equity Act and information about the availability of the OWCC Grievance Procedure. The Equity Coordinator is also Coordinator of Title IX of the Education Amendments of 1972.

PROTECTION OF PRIVACY

The following information may be released at the discretion of the college.

Directory Information: Name, address, telephone number (if it is a listed number), date and place of birth, major field of study, participation in officially recognized activities and sports, weight and height of members of athletic teams, dates of attendance, degrees and awards received, and the most previous educational agency or institution attended.

Under the Family Rights and Privacy Act of 1974, students have the right to withhold the information listed above. A student may withhold information listed above by obtaining a **notification to deny disclosure of directory information form** from the Director of Student Services. This form must be completed and turned in to the Director by the end of late registration for each semester or term. A form for non-disclosure must be submitted **each academic semester or term** to remain in effect.

The custodian of student records may release information from these records to others only upon authorization in writing from the student or upon order of a court of competent jurisdiction except as required by the president in the discharge of his duties as authorized by law, the state, and the board.

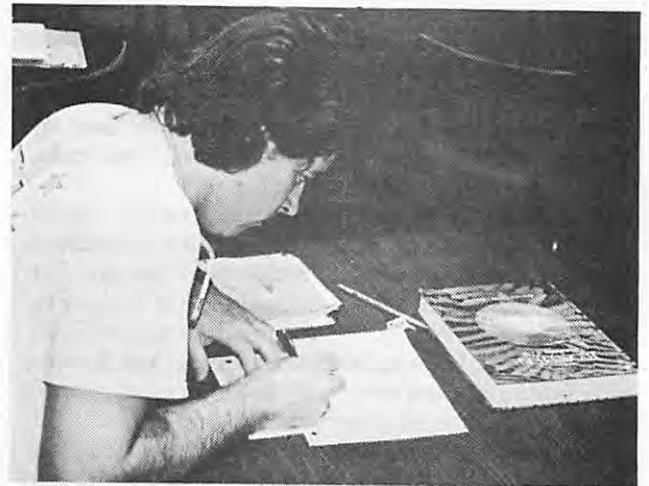

YOU would not know, looking at the intense concentration by this student, that turmoil is all around. He is studying in the College Mall, everybody's favorite meeting and studying place.

ADMISSIONS

GENERAL

All OWCC district residents legally out of grades K-12 will be admitted to OWCC without regard to age, color, creed, handicap, marital status, national origin, race, religion, or sex. However, the college reserves the right to deny admission to any program for applicants categorized in the section on Controlled Admissions (see page 10).

Applicants for courses or programs offered by Okaloosa-Walton Community College may obtain appropriate admission forms from the Admissions office. These forms are available at the Niceville campus, at Building 251 on Eglin AFB, at the OWCC Chautauqua Neighborhood Center in DeFuniak Springs, at Hurlburt Field, at the OWCC/UWF Fort Walton Beach Center, and at all high schools in the OWCC District. Each applicant will be notified of acceptance or non-acceptance for admission.

All forms and supporting documents must be submitted in sufficient time to permit processing and notification of admission status prior to registration. In unusual cases where this is not feasible, applicants may be conditionally enrolled as provided on page 10. (This does not apply to dual enrollment and foreign student applicants). Applicants whose circumstances are unique may request special consideration for admission through a formal petition. Registration for applicants admitted in this category normally will be authorized on a space available basis.

Any decision on admissibility by the Director of Admissions may be appealed to the Admissions Committee. A decision of the Admissions Committee may be appealed to the President via the Dean of Instruction.

FALSIFICATION OR FAILURE TO FURNISH CORRECT INFORMATION ON ADMISSION PAPERS WILL SUBJECT APPLICANTS TO DENIAL OF ADMISSION OR IMMEDIATE DISMISSAL.



THE ASSET TEST helps students learn what their career interests may be.

COLLEGE CREDIT ADMISSION REQUIREMENTS

College-credit programs at Okaloosa-Walton Community College include the Associate of Arts Degree Programs, Associate of Science Degree Programs, the Associate of Science Degree (Applied Science Option) Programs, Occupational Certificate Programs, College Preparatory Programs, and individual credit course enrollments.

Each applicant for college-credit programs or courses at OWCC must submit with the completed application a \$15 non-refundable Admission Processing Fee. In addition, a properly executed Residency Declaration must be submitted by applicants who claim Florida residency (see page 12, Residency Classification).

All students seeking admission to the Associate of Arts Degree Program who graduated from high school after August 1, 1987, with other than a standard Florida public high school diploma, must provide an official high school transcript verifying their completion of a secondary school curriculum. This must include four years of English and three years of mathematics, science, and social studies, or they must provide evidence of receipt of a general education development diploma. Applicants not meeting these requirements will be classified **Pre-AA Degree** until such time as these conditions are met. (See Admissions or OWCC Center personnel for additional information).

Entry-level Testing. Florida Statutes specify that selected standardized tests must be used to measure achievement of college-level communication and computation skills for admissions counseling and placement of students entering degree programs. OWCC has selected the ASSET Program for fulfilling this requirement for students who do not have other, approved, entry-level test scores on file at OWCC.

A student's indicated program will determine when entry-level testing has to be completed. Full-time, degree program students (those taking 12 hours or more) must take the ASSET prior to completing registration. Part-time, degree program students (those taking less than 12 hours) may defer the test up to 12 cumulative hours of college work.

Students not seeking a degree will be classified as "General Freshman" until they declare a major or specialization. However, they must fulfill the entry-level placement testing requirements before enrolling in English, mathematics or humanities courses.

All students planning to enter associate degree programs should endeavor to: (a) have ACT, SAT, ASSET or MAPS test scores* on file with OWCC prior to enrolling, or (b) take the ASSET on one of the college's scheduled testing dates prior to completion of registration for classes.

The ASSET is **not** a qualifying examination for admission; it is a requirement for entering a degree program at the college — for placement in college preparatory or regular degree-credit courses in computation (mathematics), communications or reading. It is recommended that high school students take the ACT, SAT, or ASSET prior to applying for admission to the college. In this way their test results can be on hand and attention given to their special needs before they arrive on campus.

The ASSET testing schedule will be published in the **Schedule of Classes** for each registration period. Additional testing may be scheduled on an "as needed" basis. The ASSET is ordinarily administered at OWCC only for persons with an application on file.

Placement test score requirements for entry into degree-credit mathematics, communications and humanities courses are determined by the State Board of Education. They will be announced each semester in the **Schedule of Classes**.

Students may not take mathematics, communications or humanities courses which are higher than the level indicated by the entry-level placement test results. Students who intend to pursue degree-credit mathematics, communication and humanities courses may enroll only in college preparatory courses. These include the following: College Preparatory English, College Preparatory Mathematics, College Preparatory Algebra, and College Preparatory Reading.

Students limited to college preparatory courses **are permitted to enroll in other curriculum areas for which they are qualified**. Students should work closely with counselors, educational advisors, and facul-



OWCC meets with high school counselors to explain college programs and how they can benefit high school students.

* Scores for tests taken within the past three years at other test centers will be accepted.

ty advisors in scheduling classes and planning their total education program to move most effectively toward graduation.

First-Time-In-College Applicants (i.e., new students, applicants without prior college work) are responsible for submitting completed, full sets of application forms and related documents. In addition, one of the following types of documentation must be provided, as appropriate:

1. An **official** record of high school work which documents graduation (these forms must be mailed directly to the OWCC Admissions Office by the high school last attended).
2. A high school equivalency diploma from a state department of education, or
3. Evidence of qualification for provisional enrollment as a non-high school graduate by virtue of age or by award of a certificate of attendance from a public high school (See page 7, "Provisional Enrollment").

Applicants With Prior College Work (i.e., transfer students or returning OWCC students) are responsible for submitting completed, full sets of admission/readmission application forms and related documents. In addition, they must provide official transcripts covering all course work attempted at all colleges or universities previously attended. (These transcripts must be mailed directly to the OWCC Admissions Office from the respective institutions. Hand-carried documents will not be accepted).

Transfer students admitted to the college with a cumulative grade point average warranting to be placed on academic probation by OWCC standards shall be placed on probation and will be subject to probation rules (see page 33).

Transfer applicants whose academic records, by OWCC standards, would have caused their suspension will not normally be considered for admission until at least one semester has elapsed since enrollment at the last institution attended, and the individual shall be subject to the Okaloosa-Walton Community College policies relative to suspension (see page 33.)

ENROLLMENT OF NON-DEGREE-SEEKING STUDENTS

Non-degree seeking students are persons who take selected college courses without the intent of completing a certificate or associate degree program. Many students attend the college to upgrade employment skills, for transfer credit, or for personal interest and enjoyment. Non-degree applicants only need to provide a completed Application for Admission and Data Form and a Florida Residency Declaration. Upon changing to degree-seeking status at OWCC or upon earning 24 semester hours, high school/college transcripts, as appropriate, will be required.

Interim-study students (i.e., transient students who normally seek enrollment only for one semester or term and whose enrollment is to be only as part of their pursuit of a degree at another institution) are advised to obtain, preferably in writing, their parent institution's authorization of course selection.

NON-COLLEGE CREDIT ADMISSION REQUIREMENTS

Non-college credit programs at Okaloosa-Walton Community College include Adult Basic Education (ABE), Vocational Preparatory/General Education Review, citizenship, Community Instructional Services, occupational courses, and self-supporting recreational and leisure-time courses. Applicants for admission to non-credit programs must submit the appropriate application materials and meet the specific admission requirements for the programs they want to enter.

ADULT BASIC EDUCATION (ABE)

This program leads to the completion of elementary studies, including basic reading, writing and mathematics. Adult Basic Education classes are designed for adults who need to develop skills in reading, writing and arithmetic. It includes other subjects related to gainful employment, such as obtaining the Florida High School Diploma (through the GED tests), or learning to speak English. Eligibility requirements are as follows:

1. Applicants must be 16 years old.
2. Applicants normally must not have received a regular high school diploma or passed the General Education Development Test (GED). (Applicants who have a high school diploma or passed the GED, yet cannot pass a state approved test at the 9th grade level, may enroll in the ABE program).

HIGH SCHOOL RELEASED-TIME PROGRAM

As the Designated Area Vocational School for the Okaloosa-Walton Community College District, the college makes facilities available to selected high school students on a limited basis for certain vocational studies requiring special laboratory and shop facilities and equipment. High school students remain enrolled in their high school. Units earned while studying in the OWCC Area Vocational School program are transferred to their high school record. Selection of participants for the program is accomplished by the students, their parents or guardians, the principal of the high school, and the Dean of Instruction of the college within space and resource capabilities of the college.

LIFELONG LEARNING

Lifelong learning students are adults enrolled in a course or instructional activity listed in the State Course Code Directory to improve competencies or enhance one's quality of life, but not to seek or upgrade wage-

earning employment skills, earn a high school diploma or its equivalent, or achieve basic skills. Criteria for admission is determined by the nature of the program or class, and these criteria are published and made available to the general public.

SPECIAL ENROLLMENTS

PROVISIONAL ENROLLMENT

Students legally out of high school but who lack a high school diploma may be granted permission to enter the Applied Science option of the Associate of Science degree program or an Occupational Certificate program on a provisional basis.

The student will continue in this category until one of the following conditions is met:

1. The standard requirements for entry into college credit programs are completed.
2. A minimum of 16 or more semester hours of general education courses are completed, or
3. Thirty-six (36) semester hours of occupational skills courses with an overall grade point average of 2.0 or higher are earned.

At this time, admission to the Associate of Science degree, applied science option or certificate program will be granted upon request.

Applicants enrolled on a provisional basis are encouraged to prepare themselves for the GED tests. Adult Basic Education classes, Vocational Preparatory classes, the Learning and Writing Skills Laboratory, tutoring, and a mathematics laboratory are provided to assist the individual in preparing for the GED tests.

Persons seeking to enroll in the Associate of Arts program are NOT eligible for provisional enrollment because a high school diploma is required for admission to AA programs. Persons who expect to receive a high school or GED diploma, and who seek to pursue an AA program without delay should consult promptly with the Admissions Office about eligibility for "Conditional Enrollment."



DUAL ENROLLMENT is open at OWCC for any 10-11-12 graders who have a GPA of 3.5 and have the recommendation of their principal. Dr. Roger Adams teaches a college-level Biology class at Niceville High School.

SPECIAL ENROLLMENTS FOR HIGH SCHOOL STUDENTS

OWCC has special concurrent enrollment programs to provide a means for acceleration among academically superior high school students. These have evolved into the following admission categories:

A. Concurrent Enrollment is available on the Niceville campus or at any center of the college for persons enrolling in non-credit courses and credit courses which do not apply toward their high school diploma. Students enrolled in these courses pay standard college application, registration, laboratory and special tuition fees where applicable. Credits earned under this program count only for college degree-credit purposes and **do not** carry simultaneous high school unit credits (See paragraph B for simultaneous credit options). Criteria to be applied for students taking courses on the Niceville campus or at one of the college centers while concurrently enrolled with their own high schools are as follows:

1. Principal's recommendation for participation in courses for which fees must be paid.
2. Program candidates must be high school students (grades 10 through 12 whose grades averaged 3.0 or higher in grades 9 through 11 or have a waiver authorized by their high school principal. Grade Point Average is not applicable for enrollment in non-credit courses).
3. Program students may enroll at the college for a maximum of seven (7) semester hours of college-credit work or fifteen (15) contact hours per week of non-credit courses each semester.
4. Program students must comply with all rules and regulations of the college and must maintain a "C" average or better. Substandard academic performance at the college or failure to comply with college rules and policies will result in the enforced withdrawal of the student from the program. Enrollment at the college should in no way jeopardize completion of regular high school work.
5. A student's academic work at the college will be validated only upon graduation from high school whether or not enrollment at the college is continued.
6. Any student participating in this program will be required to sign a statement that the student understands that the college credits earned while simultaneously enrolled in high school are not necessarily transferable to any college in Florida or elsewhere in the United States until after their validation by the College Registrar. (See item 5).

B. Part-time Dual Credit Enrollment* Admission to college courses for dual high school/college credit is offered during and after normal high school class hours, on-site in high school facilities, and in other regularly scheduled college classes within the two-county district served by OWCC. The agreements between Okaloosa-Walton Community College and the Okaloosa and Walton County School Districts, are coordinated through the Office of the Dean of Instruction at the college and the Offices of the Superintendents of the respective school systems. These persons, or their designees, work cooperatively with college department chairs and school principals in the implementation of this program.

Criteria to be applied for students taking courses for high school/college credit are as follows:

1. Students shall:
 - a. be classified as high school seniors, or as otherwise approved in the College-School System Dual Credit Agreements,
 - b. have a cumulative grade point average of 3.5 or higher on all academic coursework beginning with Grade 9 through current high school grading period (or have permission of the high school principal), and
 - c. be recommended by the principal of their own high school.
2. Courses to be offered shall be standard college degree-credit courses, exclusive of activity physical education courses. Determination of offerings and arrangements for scheduling such offerings in public school facilities shall be made cooperatively with the principal and such other officials of the public school system and of the college as are pertinent. Students may also enroll for college classes offered on the Niceville campus and at any of the college centers.
3. The units creditable toward high school graduation and college credits leading toward a degree shall be simultaneously earned by students who have passing grades in the courses approved by the student's high school and shall be limited to a maximum of seven credit hours per semester.
4. Students enrolling in college credit courses under this program will be classified as "Limited Enrollment" college students, and they will be limited specifically to college credit courses offered

*NOTE: No fees are charged to students enrolled in Dual Credit Enrollment Programs, except for activity physical education course fees, which cannot be waived.

under the Dual Credit Enrollment Program until such time as they become eligible for unconditional admission to the college.

5. No fees shall be charged to students enrolled in the Dual Credit Enrollment Program. There will not be any charges for textbooks and non-consumable workbooks, which will be returned by the students at the end of each course prior to release of any grades or credits.
6. Students participating in this program will be required to sign a statement that they understand that college credits earned while simultaneously enrolled in high school are not necessarily transferable to any college in Florida or elsewhere in the United States until after validation by the College Registrar.

C. The Full-Time Dual Credit Enrollment Program* for superior students at Okaloosa-Walton Community College will admit a limited number of highly-qualified applicants after completion of their junior year in an accredited high school. To be considered for this program, students must rank in the top 10 percent of their class, score at the 75th percentile or higher on an accepted college entrance examination, have the unqualified consent of their parents, and present the favorable recommendation of their principal. Approval of the Admissions Office based on a personal interview is also required before a final decision can be made. All admission requirements must be met prior to the regular registration period for the semester/term in which the applicant expects to enter. Applicants who are accepted will be placed in appropriate courses for which they are qualified. A student's coursework at OWCC will be validated only upon graduation from high school, whether or not enrollment at the college is continued.



A SPECIAL GRANT from the State Governor's program supporting the gifted and talented in the summer time helped OWCC form a performing group from area high schools for the summer of 1988.

*NOTE: No fees are charged to students enrolled in Dual Credit Enrollment Programs, except for activity physical education course fees, which cannot be waived.

ENROLLMENT OF FOREIGN STUDENTS

The first priority of the college is to provide educational services for students in the OWCC District. Upon fulfillment of this priority, eligible out-of-state and foreign students are welcome to attend OWCC. The following criteria are established for selective admission of foreign students to OWCC:

1. The number of applicants accepted from a particular foreign country may be limited to provide a representative cross section of cultures.
2. All required transcripts (translated into English), test results, and other required documents must be on file in the Admissions Office four months prior to the opening date of the semester for which the student is applying.
3. Applicants from foreign countries must have sufficient proficiency in speaking, reading and writing English to enable them to benefit from instruction at the college level. Such proficiency is to be established through the Test of English as a Foreign Language (TOEFL). (The required score on TOEFL for admittance to degree-credit programs at OWCC is 525. The test is administered periodically at authorized TOEFL testing centers for the U.S. and abroad.) Foreign students will be subject to the same entry-level test requirements for enrollment in degree-credit computation, communication and reading courses as U.S. resident students.
4. Applicants from foreign countries must provide evidence of academic achievement equivalent to a U.S. high school education with a "C" average or better or of graduation in the upper one-third of their school class.
5. Applicants from foreign countries must present documented evidence (certified through a U.S. Consulate) that they have the financial resources to defray all anticipated costs during their attendance at the college. (The estimated annual costs, based on 32 semester hours per year, are approximately \$8,187; registration, \$1,278; books and supplies, \$434; room and board, \$4,071; transportation \$1,361; and miscellaneous and personal, \$1,043.)
6. Applicants from foreign countries must certify that they intend to attend the college on a full-time basis and that no employment (on or off-campus) is expected to be required for them to meet expenses.
7. Each applicant from a foreign country must document sponsorship by a U.S. citizen permanently residing in the college district. The sponsor must provide a letter certifying the extent of responsibility they will assume for the applicant, including arrangements for housing and a recognized health and accident insurance program.
8. Each applicant from a foreign country must, in cooperation with the sponsor, arrange for housing and show documents of this prior to enrollment. (The college is not responsible for providing housing for any student.)

9. Applicants from foreign countries must be in good physical and mental health as certified by a licensed physician and validated by an Office of the U.S. Consulate. Immunizations must be current and properly recorded, and X-ray and laboratory reports submitted which indicate that the applicant is free from communicable diseases.
10. Applicants from foreign countries must be familiar with applicable regulations of the U.S. Immigration and Naturalization Service and must assume responsibility for complying with these regulations.
11. Applicants from foreign countries admitted to the U.S. on student visas are classified as non-Florida residents and may not be reclassified during their enrollment at the college while in an F-1 (foreign student) status.

CONDITIONAL ENROLLMENT

A student may apply for Conditional Enrollment when the admissions forms have been completed but other documents are yet to come. This is at the discretion of the Director of Admissions.

One of the opportunities available to high school seniors about to graduate is concurrent enrollment at OWCC for the Summer Semester/Term I. Under this specialized conditional enrollment program, graduating high school seniors may enroll in courses at the college during May of the year they are to graduate.

An applicant who is permitted to attend in a "Conditional Enrollment" status will be entitled to register for a maximum of one (1) semester or term to allow for the receipt and acceptance of all required admission forms and related documents. During this time, any course credit "earned" will not be recorded or released until all outstanding forms and documents have been received and the applicant is fully admitted to the college. Registration normally will be permitted only on the last day of regular registration on a space available basis.

Conditions attached to any enrollment must be satisfied before the end of the semester in order for the conditional enrollee to become fully admitted to the college. No grades or transcripts will be released for any courses in which the applicant is enrolled. The applicant will not be permitted to register for any subsequent semesters or terms until all admission requirements are met. Should data received cause the applicant to be inadmissible, actions taken will be based on that data and not the student's performance while on conditional enrollment.

CONTROLLED ADMISSIONS*

The college reserves the right to deny admission for the lack of classroom space and facilities or such other conditions as may limit enrollment. The following applicants are denied routine admission to the college:

1. With the exception of a violation of a non-criminal traffic infraction or misdemeanor anyone who has been in violation of any federal or state law within

*Applicable to all enrollees (college credit, non-college credit, full-time, part-time new and returning).

the twelve-months preceding application must petition the Admissions Office relative to admissions to OWCC.

2. Anyone under separation from OWCC or any other educational institution for nonacademic reasons.
3. Anyone who does not meet the requirements for entry into a specific program.

Such students shall be considered for admission only upon a written petition to the Admissions Committee. Applications should be submitted **no later than two (2) weeks prior to the start of any given semester**. Admissions Committee recommendations for favorable action on such petitions are subject to approval by the president or his designee.

FLORIDA CRIMINAL JUSTICE TRAINING CENTER NUMBER 21, OWCC

Florida Statute 943 provides for the establishment of criminal justice training schools as approved by the Florida Criminal Standards and Training Commission. Each criminal justice training school approved by the Commission shall obtain from the Commission a Certificate of Compliance, with the rules of the Commission, signed by the Chairman of the Commission. Any training or educational courses which are taught in any criminal justice training school must first be approved in writing by the Commission and the operation and management of the criminal justice training school must be in accordance with the policies and rules of the Commission.

Okaloosa-Walton Community College reserves the right to deny admission or limit enrollment to Criminal Justice Training Center programs to any individual who does not comply with the following requirements:



CHECKING OUT COMMUNITY COLLEGES, Clark Maxwell, Jr., Executive Director, Division of Community Colleges, left, visited the college with aides from the Governor's office to acquaint them with how community colleges are run and how they do their job.

1. Basic Recruit Training; Law enforcement and/or corrections basic recruit candidates: Candidates for law enforcement basic recruit programs must be sponsored by a Chief of Police or Sheriff. Candidates for corrections basic recruit must be sponsored by a County Jail Administrator or the Superintendent or other official in charge of a state correctional facility.
2. All basic recruit candidates must successfully complete the ASSET test or otherwise be eligible for admission to the college prior to enrollment in the basic recruit program. The ASSET test is employed by the college for determining a student's entry-level academic skills and subsequent placement in appropriate courses. If the student fails to successfully complete the ASSET test and still desires to be considered a candidate for the basic recruit program, the student must successfully complete ENC 1139 — Review of Essay and Writing Skills. In addition, the student must retake and successful-

ly pass the ASSET test. A second failure of the ASSET test will render the student ineligible for participation in the Basic Recruit Program.

3. All basic recruit candidates must provide a Copy of OWCC Form 1 — Sponsorship Form, Law Enforcement/Corrections, signed by the Agency Administrator of the sponsoring agency.
4. In-service law enforcement, correctional, and correctional probation and parole officers, to include part-time and auxiliary officers, who desire to enroll in Advanced and/or Specialized Courses offered by the Criminal Justice Training Center, must provide the Training Center with a copy of Criminal Justice Standards and Training Commission Form 15A — Training Authorization. This form must be signed by the Agency Administrator. The officer concerned must initial the appropriate block indicating his or her desire to take the course for salary incentive credit or mandatory retraining credit, but not both.



THE OWCC OFFICE at the Fort Walton Beach Center is headed up by Dr. Ned Couey who is assisted by Nancy DiBattista.



THE EGLIN TEAM, the OWCC staff and UWF staff join together to pose in their combined office which serves Eglin AFB personnel as well as area citizens.



THE STAFF at the Chautauqua Neighborhood Center: Dr. Flora Conger, Director; Charlotte Langley, Educational Advisor; Judy Metzger, Secretary; and Tammy D. Lawrence, Secretary.



THE HURLBURT CONNECTION is Larry Tashlick, Base Education Officer, and Hilda Anger, the OWCC representative.

FINANCE

GENERAL

Full payment of fees is required when registering for classes at Okaloosa-Walton Community College. For your convenience, payment may be made using either MASTERCARD or VISA credit cards. Students who have not paid their fees will not be admitted to classes. No faculty or staff member of the college, other than the comptroller and the College President, has the authority to defer payments. The ability to grant deferments is specifically defined and limited by Florida Statutes.

FINANCIAL ASSISTANCE

The College offers and administers a variety of financial aid programs. Inquiries concerning financial aid should be directed to the Student Financial Aid Office.

RESIDENCY CLASSIFICATION

Students are classified as Florida residents or as non-Florida residents. Criteria for determining residency status are detailed in the Florida Statutes, the administrative rules of the State Board of Education, and the policies of the OWCC District Board of Trustees. Information for Residence Classification and Residency Declaration forms are available in the Registrar's Office. Completed Florida Residency Declaration forms are required of all new students.

A student's "residency classification" is determined at the time of initial registration. After establishing residency in the State of Florida as defined by law, a non-resident student may petition the Registrar for a change in residency status by completing a new Florida Residency Declaration form.

Active-duty military personnel (including dependent members of their immediate families holding current, valid ID cards) stationed in Florida are classified as Florida residents.

Providing false residency information is a violation of Florida State Law and could result in disciplinary action being initiated. The college will correct the fees assessed for those students who misrepresent their place of legal residence and will issue an invoice for the increase in tuition.

MILITARY ASSISTANCE

Active-duty military personnel who enroll in college-credit programs through base education offices may be eligible for financial assistance through the Military Assistance Agreements that OWCC has in effect with Eglin and Hurlburt Air Force Bases. Contact the base education office for details.

VETERAN'S BENEFITS AND ASSISTANCE

Refer to the Instructional Programs — Standards and Regulations section of this catalog. See page 30.

REFUND POLICY

Refunds resulting from registration adjustments are processed automatically at the end of the registration period. Students are responsible for completing the proper withdrawal or drop/add forms obtained from the Registrar's office. They must present the properly completed forms to the Business Office for processing of authorized refunds. Refunds will be made in the form of a check and will be mailed to the student. In situations where a student has outstanding financial obligations, (i.e. student loans, library fines, parking fines, etc.), refund amounts will be reduced by the amount owed to the college.



THE COMPTROLLER, Ken Burdzinski with staff members, Chuck Brocketto, and Bobbie Sweeney.

REFUND POLICY FOR NON-CREDIT COURSES

1. All fees paid, less any outstanding financial obligations, will be refunded if a student presents the proper forms for withdrawal from a non-credit class on or before the scheduled deadline for registering for that class.
2. Fees will be recomputed and a refund check will be mailed or additional fees collected as appropriate when a drop/add form is submitted on or before the scheduled registration deadline for non-credit classes.
3. No refunds will be made or financial credit granted after the scheduled deadline for registering for any class.
4. Full financial credit will be granted for classes cancelled by the college. Students will have an opportunity to select an alternate class to which the fees can be applied. If another class is not selected, a refund will be processed automatically.

REFUND POLICY FOR COLLEGE-CREDIT COURSES

1. Admission fees and graduation fees are not refundable.
2. Fees will be refunded if a student presents the proper forms for withdrawal from the college on or before the deadline for registering for the class.
3. Fees will be recomputed and a refund check will be mailed or additional fees collected when a drop/add form is submitted on or before the scheduled registration deadline.
4. No refunds will be made or financial credit granted after the scheduled deadline for registering for any class.
5. Any and all refunds to students receiving financial assistance will be made in accordance with the terms of the assistance program.
6. Full financial credit will be granted for classes cancelled by the college. Students will have an opportunity to select an alternate class to which the fees can be applied. A refund will be processed automatically if another class is not selected.

DISHONORED CHECK POLICY

Checks returned by the bank will be processed as follows:

1. The student will be notified by telephone and/or certified mail that their check was dishonored by the bank. A \$10 return check charge will be applied to the student's account.
2. The student will have 7 calendar days to pay for the check and the return check charge in cash or certified funds. Failure to make the payment will result in cancellation of enrollment.
3. Reinstatement after enrollment cancellation will be considered only after full payment and by petitioning the Director of Student Services. Reinstatement will be at the discretion of the Director.

4. A student who habitually issues bad checks may be subject to disciplinary and/or legal action even though checks are paid.
5. The college is authorized to forward unpaid dishonored checks and information relating to their default to a collection agency after 30 days.

STUDENT LOANS

The college offers students with demonstrated financial need a short-term, no-interest, loan program to assist in the payment of fees. Specific details on the loan program are contained in the Financial Aid section of this catalog.

Students obtaining loans are required to repay them in no more than three installments at specified intervals. The College Student Loan policy, as approved by the District Board of Trustees, requires that EACH payment be made by the designated date. Failure to make each payment will result in a student being administratively withdrawn. Students will be considered for reinstatement only after paying the delinquent loan amount and petitioning the Director of Student Services to reinstate them. Reinstatement will be at the discretion of the Director. A student who has a history of failing to comply with the terms of the loan program will be required to pay the FULL LOAN AMOUNT prior to being considered for reinstatement.

Administrative withdrawal does not release a student from the obligation to repay their loan. All loans that remain unpaid after the final installment due date, will be referred to a external agency for collection.



VISITING THE CAMPUS, Senator George Stuart, Chairman, Committee on Higher Education and the Secretary, Barbara Cohen, listen to briefings and presentations by college personnel and students.

FINES, PENALTIES, AND INDEBTEDNESS

Students can avoid being assessed fines and penalties by familiarizing themselves with established policies and procedures as published in this catalog, the Student Handbook, the Semester Schedule of Classes booklet, and posted throughout the campus. Failure to comply with the college's regulations can result in fines being assessed that will cause grades, transcripts, diplomas, certificates, and other official documents from the college to be withheld until all fines, penalties, and indebtedness have been paid. Students will also not be allowed to re-register until all debts are paid in full.

Parking Fines

The operation of private vehicles on the OWCC cam-

pus is a privilege and not a right. Individuals who show poor judgement or lack of consideration for the rights, privileges, and safety of others subject themselves to the possibility of having this privilege revoked. Violating the college's parking regulations can result in a \$10 parking ticket or the vehicle being towed at the owner's expense. Chronic offenders will be subject to disciplinary action by the college.

Complete parking and traffic regulations are published in the Student Handbook and the Semester Schedule of Classes.

FEE CHANGES

Any and all fees are subject to change prior to any enrollment period.

*FEE SCHEDULE (PER SEMESTER) *

Admissions Processing Fee	\$15
Required for all applicants seeking admission to OWCC college-credit courses for the first time. This is a one-time charge and is not refundable.	
Graduation Application Processing Fee	\$15
(Non-refundable)	
Registration for Florida Resident Students per semester credit hour (SH) and/or per semester credit hour equivalent (SHEE)**	
Advanced & Professional	\$20
Postsecondary Vocational	\$20
Postsecondary Adult Vocational	\$12
Supplemental Vocational	\$18
Adult General Education:	
Adult Basic and Adult Secondary	\$12***
College Preparatory	\$20
Vocational Preparatory	\$12***
Recreational & Leisure	At Full Cost
of Instruction	
Registration and Tuition for Non-Florida Resident Students per semester credit hour (SH) and/or per semester credit hour equivalent (SHE)**	
Advanced & Professional	\$40
Postsecondary Vocational	\$40
Postsecondary Adult Vocational	\$23
Supplemental Vocational	\$35
Adult General Education:	
Adult Basic and Adult Secondary	\$23***
College Preparatory	\$40
Vocational Preparatory	\$23***
Citizenship (Community Instructional Services)	*-0-
Recreational & Leisure	At Full Cost of Instruction
Laboratory and Special Tuition Fees	****
Returned Check Charge	\$10
GED Test	
Total Test Battery	\$25
Individual Test Re-Takes	\$5

Writing Test Re-Takes	\$6
Special Service Charges	At Cost
(Lock and locker rentals, etc.)	
Comprehensive Examination Testing Fee:	
100 percent of the normal Resident or Non-Resident course fee (excluding any lab fee) due and payable before the test is administered.	

COST SUMMARY

The range of basic charges for a typical full-time college-credit student, per semester, registered for 16 semester hours:

Florida Resident	
Fees	\$335
Books and Supplies	\$225
Non-Fla. Resident	
Fees	\$655
Books and Supplies	\$225
Food, housing, and travel costs depend upon the student's habits and circumstances.	

*Subject to change. Fees for each enrollment period is published in class schedules. These fees apply whenever applicable, except: (1) courses in which complimentary instructional services or equivalent program costs are provided by appropriate persons, agencies or organizations; or (2) when specifically waived by the Board of Trustees.

Registration and tuition fees include the one-dollar student services and activities fee, **except Recreation & Leisure courses. ***This fee will be assessed for students with high school diplomas who enroll in Adult General Education, Vocational Preparatory Courses, but enrollees **without** a high school diploma or equivalent are exempt.

****Laboratory and special tuition fees are to cover unique costs related to any given course. The fee amount is determined course-by-course based on costs for each. A schedule of fees is on file in the Business Office and will be available during registration for each semester.

STUDENT SERVICES

The office of Student Services exists primarily to enhance the teaching and learning process at Okaloosa-Walton Community College.

The term "student services" is used collectively to describe all the programs, services, and activities designed to support the goals outlined in the purpose statement of the college.

Student Services is committed to a close and cooperative working relationship with all other departments within the college to achieve the common goal of student development. In addition, Student Services is committed to helping students reach their full potential by assisting in career planning and academic adjustment. It is committed to supporting those extracurricular activities that add to the quality of student life.

Student Services is the adjusting link between the student as a person and the college as an institution.

ACADEMIC ASSISTANCE

Academic advising is available to help students identify courses, select majors, select a transfer institution and assist with academic problems. This planning of academic goals is provided by faculty, counselors, educational advisors, and at the OWCC centers. Upon declaring a major area of study, each student is assigned to a faculty advisor who is responsible for providing close, personal attention and academic advice about their major.

Experienced college counselors and educational advisors are available to provide career counseling to students who have not chosen a major. Counselors are located in the C-Building, the Student Services Center, on the Niceville campus. Educational advisors are located at each of the centers. An appointment is advisable, but walk-ins will be served if at all possible.

The efforts of the faculty and counseling staff are intended to insure that each OWCC student has the opportunity and information to make decisions that are best for them.

The Learning Skills and Writing Laboratory provides a valuable service to students who wish to improve their abilities in writing, reading, study, and subject matter areas. Participation in this program is arranged by the student, a faculty advisor or a counselor. Participation is voluntary; however, a counselor or faculty member's recommendation to participate should be seriously considered by the students. This lab is located on the north mezzanine of the library.

The Math Laboratory, which is located in the Math-Public Services Building, (L-Bldg.), Room L101, is open to all students who need additional help in mathematics courses. The hours of operation vary from semester to semester.

The Tutorial Program is coordinated by a counselor located in the Student Services Center. This program is designed to match students who need help in a specific course with qualified students who are willing to volunteer their time and energy. The coordinating counselor will attempt to bring tutor and student together. Applications to participate in the program can be found in the Student Services Center. Because the program is relatively small, requests for a tutor should be made as early as possible in the semester.

CAREER PLANNING ASSISTANCE

Students who are undecided about their career plans are encouraged to make an appointment with their faculty advisor, educational advisor or a counselor to begin the career planning process. The next step is to go to the Student Services Center to explore the resources available. These resources can include career-related testing, CHOICES (an easy-to-use computer program that assists in career identification based upon personal answers), career research in the Career Information Center, and additional personal counseling to assist the decision process. Students who have made career decisions are more likely to be academically successful than those who have not.

GOVERNANCE

Campus governmental processes are shared by elected and selected members of the faculty, student body, administration, and college staff to provide everyone the opportunity to seek solutions as one body, and promote the respect of the college community.



THE STUDENT GOVERNMENT ASSOCIATION (or SGA as most people refer to it) looks out for the welfare of the students and plans fun, events, and entertainment for the students.

The College-Wide Council to which students and employees are elected and selected provides input into the governance and decision-making processes of the college. It is responsible for advising and recommending programs, policies, and approaches to the President for his action and referral to the District Board of Trustees.

The Student Government Association represents the student body of the college. Every student of OWCC is a member of this association. The governing body of the SGA is the Student Senate. Senators are elected to serve one-year terms. One of their responsibilities is to make and implement decisions concerning student activity fee monies allotted for discretionary use. Projects in the past have included the purchase of picnic tables, game room equipment, public telephone facilities, equipment for student use at the Centers, the monitor system in the Mall, and table games for check-out use. They sponsor, fund, and staff where appropriate, picnics, movies, dances, entertainment, food drives for the needy, blood drives, and chili suppers for the night students. All students are encouraged to support their SGA and run for office. The SGA Senate is housed in K-136 in the Mall.

The Inter-Club Council serves to promote unity and cooperation among the *recognized* student organizations of the college. This council is responsible for coordinating activities and competition among the various student organizations.

HEALTH SERVICES

First aid and emergency services are available to students by qualified college personnel during the weekdays and evenings and by security personnel during the weekends. Parents or nearest relatives are notified as promptly as possible in the event of serious injury to or illness of students.



NURSE SHERMER helps a student by bandaging a scratch. Her office is located in the College Mall.

AIDS information and Counseling will be provided by a counselor in the Student Services Center (C1 Bldg.). Recognizing that information is the key to prevention of this disease, every student is encouraged to make use of this information to protect themselves and others. AIDS counseling will be provided in a professionally confidential manner.

Alcohol and Drug Abuse information is available to all students from a counselor located in the Student Services Center who is assigned that responsibility by the college. This counselor maintains information on local treatment programs and their locations, and will provide alcohol and drug abuse counseling.

Students are warned that the use, manufacture, distribution, sale, or possession of alcoholic beverages or illicit drugs on campus or at any college-sponsored event or activity is prohibited by college policy. Violation of this policy will subject a student to disciplinary action.

JOB PLACEMENT SERVICES

Students who are graduating from OWCC or are leaving to seek employment are assisted by the faculty in finding full-time employment. Students or ex-students who are searching for part-time or full-time employment can often be assisted by the Student Job Placement Service located in the Student Services Center (C1-Bldg.). Students should fill out an application stating what their qualifications are, etc., so as to be considered for referral.

Prospective employers of students are required to file a written assurance of non-discrimination on the basis of age, color, creed, handicap, marital status, national origin, race, religion, or sex before their job openings are listed by the College's Student Job Placement Service.

ORIENTATION

New student orientation and pre-registration briefings are offered to all new OWCC students at the beginning of each semester's registration. During orientation, students receive valuable information about college policies, procedures, and academic programs.

College Opportunities Management, Planning, and Academic Skills Seminar (COMPASS) is a semester-long course designed to orientate entering Associate of Arts degree (AA) program students to OWCC. This seminar will assist students to identify and strengthen their study skills weaknesses, choose a major based upon reasonable career choices, and to become familiar with the requirements of the College-Level Academic Skills Test (CLAST).

COMPASS is required of all entering AA degree students. Full-time AA degree students must enroll in this course their first semester; part-time AA degree students must take this seminar before completing 12 semester hours. (Transfers and active duty military are exempt from this requirement).

SERVICES TO STUDENTS WITH SPECIAL NEEDS

"**Students with Special Needs**" includes a wide variety of students. A partial list would include the physically handicapped/disabled, persons with learning disabilities, dyslexics, limited English proficiency (LEP) students, the educationally disadvantaged, the economically/culturally disadvantaged, and members of certain minority groups.

The Counselor/Coordinator of Services to Students with Special Needs is located in the Student Services Center. This counselor can facilitate the loan of certain equipment which will enhance the learning experiences of persons who are physically handicapped/disabled. Some of the services available to the physically handicapped/disabled, or learning disabled students include notetakers, tutors, and/or readers.

To provide these services, the college depends upon voluntary, self-identification of handicapped/disabled students. Information provided is considered confidential and is used solely to aid students to achieve their academic potential. Voluntary self-identification can be done at the time of admission or at any time thereafter in the Office of Student Services, at the Registrar's office, or at any center.

STANDARDIZED TESTING

College placement tests are required before registration for degree-seeking students and all students seeking entry into college-credit courses in English, mathematics, or reading. These tests include ACT, SAT, MAPS or ASSET. The ASSET test is administered by OWCC and is free. These tests are required by law but are not admissions tests. The results are used to place students in the proper courses. Prospective students should arrange with the Coordinator of Testing for a time to take the ASSET. This test can also be taken at all the Centers and at the Niceville campus after regular hours.

Transfer students should have their transcripts evaluated by the Registrar's office to determine if they will be required to take any of the placement tests.

College Level Examination Program (CLEP) tests are a nationally developed program for credit-by-examination. Credit may be granted for scores at or above the established criterion score on approved tests. Fees are set by the College Entrance Examination Board. Tests for this advanced placement mechanism can be arranged through the Coordinator of Testing.

STUDENT ATHLETICS

OWCC is an active member of the National Junior College Athletic Association (NJCAA) and the Florida Community College Activities Association (FCCAA) which is composed of all public community colleges in Florida.

Intercollegiate Sports at OWCC operate under the rules and regulations of NJCAA and FCCAA. Varsity athletes enjoy the privilege, honor, and social distinction of representing the college in the field of athletic competition.

Representation of the college is open by competitive selection to all students provided they meet the eligibility requirements of the FCCAA. Tennis is the inter-collegiate sport in which OWCC will participate this year.

Times, schedules, and places of meeting for activities are posted on the bulletin boards located in the gym.

Extramural Activities are competitive activities which provide seasonal, organized competition with other colleges and/or off-campus organizations for OWCC students enrolled for six or more semester hours and college employees. These activities are governed by FCCAA eligibility rules and regulations. Last year's activities were highlighted by men's soccer.

Intramural Activities are those activities which provide intra-college competition for currently-enrolled OWCC student, faculty and staff members, regardless of level of skill. In the past, these have included team sports such as flag football, volleyball, soccer, softball, and basketball as well as individual sports such as chess, backgammon, pool, golf, and bowling. Classes, clubs, organizations and independent groups are encouraged to form teams.

Appropriate awards are given to winning teams and players. The highest awards each year are the President's High Point Plaques presented to the woman and the man with the highest number of points. Often, the winning teams in basketball, volleyball and flag football will meet other winning teams from colleges within Region I to determine who keeps the trophy for a year.

Times, schedules, and places of meeting for activities are posted on the bulletin boards located in the gym.

RULES AND REGULATIONS

The rules and regulations established by the college are intended to provide for the welfare and safety of the whole college community. Rules and regulations which apply to students can be found in the Student Handbook which is distributed at orientation and the semester Schedule of Classes which is available throughout the college. Other rules and regulations can be found in the Board of Trustees Policy Handbook and the Handbook for Student Organizations, copies of which can be obtained in the Office of Student Services. Please refer to these documents for guidance on dress, children on campus, parking and traffic regulations, and other matters of interest to students.



THE COUNSELORS pose with their centerfold, Gordon Jasperson.

STUDENT CONDUCT

To maintain the environment in which learning can take place and student development can progress, the college reserves the right to establish rules and regulations that promote this goal. Attendance at OWCC is a privilege. This privilege can be suspended or removed from a student who violates the rules and regulations set forth in this catalog, the Student Handbook, or other policies approved by the District Board of Trustees as well as published laws, and ordinances by which all must abide.

Any act or behavior by a student which tends to interfere with or otherwise disturb the orderly conduct, process, functions and interests of the college is prohibited. Such acts include, but are not limited to:

- cheating in any form;
- gambling;
- theft, vandalism or destruction of college property, or property of members of the college community;
- falsification of personal or college records; the use, manufacture, distribution, sale, or possession of alcoholic beverages or illicit drugs on campus or at any college-sponsored event, or activity;
- violence against any member or guest of the college community;
- hazing; and
- harassment.

All violations of these rules are referred to the Director of Student Services who will initiate disciplinary action. Action available to the college can extend to disciplinary probation, suspension or expulsion.

Disciplinary probation requires compliance with the following restrictions and obligations:

1. Conformance with all college policies, rules, and regulations pertaining to student behavior as specified in the current College Catalog, Student Handbook, or any other official college publication.
2. Avoidance of involvement in actions or activities which could be considered disruptive to the educational process or detrimental to the health, welfare, and safety of any member of the college community.
3. Avoidance of participation in any student extracurricular, organized activity.

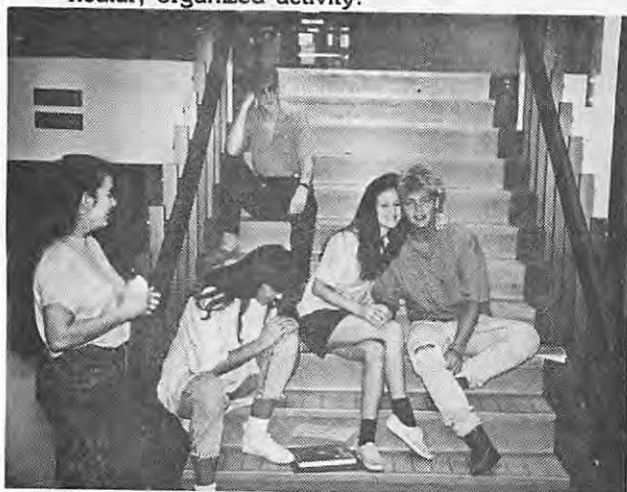

WAITING FOR CLASS doesn't appear boring.

4. Reporting on a scheduled basis for appropriate counseling sessions with an assigned college counselor.
5. Remaining in full compliance with the conditions of applicable court-imposed probation/parole.
6. Reporting on a scheduled basis to the Director of Student Services for review of compliance with the terms of disciplinary probation.

Disciplinary suspension terminates a student's enrollment at OWCC for a specified period.

Expulsion separates a student from the college for an indefinite period with readmission subject to the recommendation of the Admissions Committee and the approval of the President.

Students who become ineligible for enrollment because of disciplinary action may not continue their education through any programs, activities, or offerings of Okaloosa-Walton Community College until such time as they may be readmitted to the college.

If after inquiry, the Director of Student Services determines that the alleged behavior did occur, the director may take one of the following actions: place the student on disciplinary probation, or recommend to the President that the student be suspended or dismissed.

No student may be suspended or expelled without the approval of the College President.

Any appeals from these decisions may be handled by student formal grievance procedures. These procedures can be found in the Student Handbook which is distributed at orientation. Any student may obtain a copy of the Student Handbook from the office of the Director of Student Services, the Student Activities Office, the Equity Coordinator or any Center Director.

STUDENT GRIEVANCE

Any student who believes they have been done an injustice through the action of another student, a college employee, or other person acting for the college may initiate a grievance under the Student Grievance Procedures which is published in the Student Handbook. State Board of Education Rules and College Policies are not grievable; only the application or interpretation of rules or policies may be grieved.

OWCC's student grievance procedures apply to all complaints on the part of students which may arise in the areas of instruction, general student services and matters that involve rights provided for under the College's Equal Access/Equal Opportunity Plan and the Florida Education Equity Act and when they directly affect the personal interests and well-being of individual students. Complaints of this nature should be directed to the office of the Equity Coordinator who is located on the second floor of the Administration Building.

Complaints which do not directly affect the personal interest and well-being of individual students and which are not otherwise covered by these procedures shall ordinarily be referred for resolution to the Director of Student Services who is located in the Student Services Center (C1-Bldg.).

STUDENT ORGANIZATIONS

The college has chartered a number of student organizations including general and special interest groups, honor societies, service clubs and social groups. These organizations cover a wide variety of interests and activities. Membership is open to all students who qualify, without regard to age, color, creed, handicap, marital status, national origin, race, religion or sex (except wherein gender is the fundamental basis for that organization by approved charter provisions).

The following groups are, or recently have been active, recognized OWCC student organizations:

Phi Theta Kappa is a national honor society whose goal is to honor students who have attained a high scholastic standing, and to provide them with the opportunity to congregate and sharpen their intellects. Service projects and social activities are available to the membership which is open to men and women.

Student Christian Fellowship, or SCF as it is known to the students, promotes high standards of Christian character and provides the opportunity for spiritual growth. Membership is open to all students.

Music Theatre endeavors to produce at least one Broadway-style musical annually. Participation is open by audition to all students and members of the community.

Outing Club membership is open to all students, faculty, and staff members. The group organizes various outdoor activities and promotions.

Proscenium Playhouse is the drama group of the Fine and Performing Arts Department. Its goals are to foster an interest in and an appreciation of the theatre arts, to produce plays, and to provide an outlet for the creative abilities of the students and community members.

Artista is dedicated to the promotion of the visual arts on campus. Artista fosters interest and participation in student-related art activities. Membership is open to all students.

Baptist Campus Ministry is open to all students for the purpose of guiding them in Christian witness and fellowship.

Black Student Union strives to promote black awareness and to be of service to the college and the community. Membership is open to all students.

College Republicans provides an opportunity for OWCC students to find political expression and recognition through association with the Republican Party. It is open to all students.

OWCC Community Chorus is open to all students, staff, and interested members of the community. The Chorus performs major choral compositions during the fall and spring semester of each year and maintains a membership of sixty or more auditioned singers.

OWCC Show Choir is a small, by audition-only mixed choir, comprised of college students who are enrolled full-time. The group specializes in up-tempo, contemporary, entertainment oriented music ranging from jazz tunes of the 40's to the latest pop tunes, as well as show-stopping selections from Broadway and Hollywood. Choreography is incorporated into each performance.

Rock and Jazz Ensemble in big band, combo and rock groups are open by audition to any student instrumentalist who wants to develop professional performance abilities. Must have some experience in high school bands, etc.

The Northwest Florida Symphony Orchestra of OWCC is open to all OWCC students, staff, and interested members of the community who have a demonstrable performance skill with an orchestral instrument. The Orchestra draws its membership of over sixty players from throughout the Panhandle and into South Alabama.

Reader's Theatre is a popular form of interpretive reading for group participation. They conform to no one style and invite imaginative experimentation.

Delta Psi Omega is a large, national honorary fraternity whose purpose is to stimulate interest in dramatic activities.

Circle K is a service organization sponsored by Kiwanis International and is dedicated to college and community service. The Kiwanis Club of Niceville is currently the local sponsor.

There are other chartered organizations which are not currently active such as **Distributive Education Clubs of America, Phi Beta Lambda Business Education Fraternity, Raider Review Newspaper, Jefferson Democratic Association, Raider Sailing Club, and Veterans Club**. If you are interested in reactivation of one of these organizations, check with the Student Activities Office to learn how this can be done.

Students are encouraged to participate in student activities and enjoy them as long as they do not interfere with their studies.



HONOR SOCIETY, Phi Theta Kappa.

FINANCIAL AID

STUDENT FINANCIAL AID

Okaloosa-Walton Community College's mission is to serve everyone who can benefit from a college education. No one thinking of college should hesitate about applying for admission because of financial need. Okaloosa-Walton Community has a variety of financial assistance sources for students.

In addition to its own funds, Okaloosa-Walton Community College participates in several federal programs including the *Pell Grant*, the *Supplemental Educational Opportunity Grant (SEOG)*, the *College Work Study Program (CWSP)* and the *Stafford Loan* (Guaranteed Student Loan). Florida Residents are also eligible to receive state funds through the *Florida Student Assistance Grant (FSAG)* and the *Public School Work Experience Program (PSWEP)*. Institutional, local, and state scholarships are also a means of financial aid for students who qualify at Okaloosa-Walton Community College.

PURPOSE OF OWCC'S FINANCIAL AID PROGRAM

The purpose of financial aid is to make up the difference between what you can afford to pay and the actual cost of your education. This difference is what we call a student's financial need. Financial need can be illustrated by using a formula:

Cost of attendance — Individual or family contribution = NEED. It is universally accepted that the primary responsibility for payment of the cost of education rests with students and their families. Factors considered include: family income, student's income, assets, number of children in family, number of family members in college, and special circumstances affecting the family's ability to assist, such as medical expenses and disaster. Financial need is not simply a lack of funds left for college after nonessential expenditures, a result of parent's or student's refusal to do or accept reasonable responsibility, or because of failure to plan adequately for college expenses.

It is intended that financial assistance administered by Okaloosa-Walton Community College does not discriminate on the basis of race, sex, age, national origin, religion, marital status or handicap. Specific additional non-discriminatory criteria and academic standing status may be required for particular assistance or scholarships.

COLLEGE COSTS

Okaloosa-Walton Community College's fees are designed to make college affordable for most students. The typical costs for attending Okaloosa-Walton Community

College for 16 semester hours are on p. 14. In addition, allowance should be added to these figures for such items as room and board, personal expenses, medical insurance, transportation and supplies. Dependent students (living at home) usually have parental support, reducing direct education costs. Refer to the college schedule of classes each semester for offerings which involve special fees.

PROCEDURES FOR APPLYING FOR FINANCIAL AID

Entering students seeking financial assistance should contact the Student Financial Aid office, which is located in the Student Services Center on the Niceville campus. The following procedures need to be followed when applying for financial aid at Okaloosa-Walton Community College:

1. Complete the Okaloosa-Walton Community College *Application for Admission* and return it to the office of Admissions. Please be aware that your financial aid award cannot be processed until you have been officially accepted for admission at Okaloosa-Walton Community College.
2. Complete the *Family Financial Statement (FFS)* packet that is provided by the American College Testing (ACT) System. The FFS may be obtained from any Okaloosa or Walton counties secondary school, Eglin or Hurlburt OWCC offices, the OWCC/UWF Fort Walton Beach Center, the



NEED A FRIEND? Go visit Financial Aid. This crew can help you out.

OWCC Chautauqua Neighborhood Center, DeFuniak Springs, or from the Financial Aid Office on the Niceville Campus. Students should specify "0745" as the code number for Okaloosa-Walton Community College in the appropriate section of the FFS. A STUDENT MUST REAPPLY FOR FINANCIAL AID EACH ACADEMIC YEAR. A student's financial need will be evaluated each year in light of any changes in the family circumstances and any changes in the cost of attending Okaloosa-Walton Community College.

3. Complete the *American College Testing Student Data Form* (SDF). This form is used by Okaloosa-Walton Community College as its institutional application for financial aid. It can be found in the FFS packet or by contacting the Student Financial Aid Office at Okaloosa-Walton Community College.
4. After mailing the FFS to the American College Testing System, the student will receive a *Student Aid Report* (SAR) in approximately four to eight weeks, providing the FFS was completed correctly. This report is the result of the NEEDS ANALYSIS process. The SAR must be reviewed by the student for accuracy, signed by the appropriate individuals and submitted to OWCC's Financial Aid Office. Additional information/forms might be requested by the Financial Aid Office (i.e. income tax forms) if the student is selected for a process called verification and/or documentation (see later sections of the Financial Aid section of the catalog for additional information on these processes.) All information submitted to the Financial Aid Office is held in the strictest confidence and is discussed only between you (or your family) and a member of OWCC's staff.
5. If you are unconditionally admitted to Okaloosa-Walton Community College and your SAR has been received, analyzed and a need has been determined, and you meet all other eligibility requirements (as explained in later section under eligibility) you will receive an AWARD LETTER. The award letter specifically states the amount of financial aid the student will receive if they attend Okaloosa-Walton Community College. The total assistance that a student receives cannot exceed their need. Thus, all resources, including those from outside sources, must be considered in evaluating your total financial need or adjusting your aid award.
6. **The award letter must be signed and returned to Okaloosa-Walton Community College's Financial Aid Office within fifteen (15) days from the day it is dated for the student to be eligible to receive the funds as specified in the letter.**

Students needing assistance in completing any of the application forms involved in the above procedures should contact the Financial Aid office. Students have a right to understand how their financial aid award is determined. Okaloosa-Walton Community College's

Financial Aid Office is always willing to discuss financial aid decisions with students and parents to promote a better understanding of financial aid opportunities for students.

TRANSFER STUDENTS

All students applying for aid who have attended post-secondary institution(s) since high school must supply Okaloosa-Walton Community College with a *Financial Aid Transcript* (FAT) from that school(s). NO ASSISTANCE can be awarded under federal programs until the *Financial Aid Transcript(s)* is received by OWCC.

DEADLINES FOR APPLYING FOR FINANCIAL AID AT OWCC

Applications for financial aid should be made well in advance of registration for courses. The PRIORITY CONSIDERATION DEADLINES for applying for financial aid at Okaloosa-Walton Community College for 1989-90 by semester are:

Fall Semester April 1, 1989
 Spring Semester October 1, 1989
 Summer Semester February 1, 1990

If a student has completed all of the requirements for receiving financial aid at OWCC, and they have received their award letter before the above listed priority dates for the semester in which they are registering, they can be included in the early disbursement of funds. The first disbursement is expected within a few weeks from the close of late registration each semester. **Those students not meeting the priority deadline need to be aware that they may experience lengthy delays in receiving their financial aid.**

Florida residents of at least two years standing should apply not only for the Pell Grant but also for the Florida Student Assistance Grant (you may receive both). The Florida version of the FFS must be used for this purpose. All applications for the Florida Student Assistance Grants for the 1989-90 academic year must be in Tallahassee no later than April 15, 1989.



THIS GROUP is making the most of a class break by enjoying the fun and atmosphere in the College Mall.

POLICIES AND PROCEDURES

ENROLLMENT STATUS

The amount of aid a student is eligible to receive at Okaloosa-Walton Community College is dependent on the student's enrollment status. Students enrolled for 12 or more semester hours at the end of the drop/add period are considered to be full-time for a given semester and their financial aid will be calculated on a full-time enrollment status. Eligible part-time enrollment requires a course load of at least six, but not more than 11 semester hours. **STUDENTS WHO ENROLL, INITIALLY, FOR LESS THAN SIX SEMESTER HOURS ARE INELIGIBLE FOR FEDERAL FINANCIAL AID.** Students whose enrollment fluctuates from full-time to part-time, or vice versa, shall have their eligibility prorated (full-time, three quarters, or half-time). The amount each student is eligible for as a part-time student is listed on the student's award letter.

Financial aid award status (full-time, three-quarters, or half-time) will be based on the number of credit hours at the **END OF LATE REGISTRATION FOR EACH SEMESTER.** For award letters sent after these dates, status will be determined by the number of credit hours in which a student is enrolled at the time the award letter is sent. If not enrolled for the appropriate number of credit hours at that time, a student's award will be revised downward to reflect this change. Awards will not be revised upward if students add classes after that date.

ELIGIBILITY

For a student to be eligible for federal financial aid at Okaloosa-Walton Community College —

- A student must be a regular student enrolled or accepted for enrollment in a PROGRAM OF STUDY.
- A student must have a high school diploma or its recognized equivalent (state GED), or demonstrate the ability to benefit. Ability to benefit allows students who are not high school graduates and are above the age of compulsory school attendance in Florida to be considered for federal financial aid.
- A student must be a U.S. citizen, or permanent resident.
- A student must maintain a **STANDARD OF SATISFACTORY PROGRESS** and **ACADEMIC GOOD STANDING** which includes the following three factors:
 1. Satisfactory grade point average which must approach the standards necessary for graduation as the student progresses through the program (see chart C on page 24.)
 2. A limit to the number of semester hours a student may attend college using federal financial aid resources. OWCC places a limit of 124 semester hours.

3. Incremental progress toward the required number of semester hours necessary for graduation which must be checked at least once a year (see charts A and B on page 24).
- A student must not owe a refund on a federal grant at any institution.
 - A student must not be in default on a federally-funded or insured student loan.
 - A student must have signed a State of Educational Purpose and a Statement of Registration Status.

Minimum standards have been adopted and are to be applied uniformly and equitably to all federal financial aid programs.

For a student to be eligible for FLORIDA STATE PROGRAM participation* at Okaloosa-Walton Community College the following checklist of requirements is provided:

FULL-TIME STUDENT (12 hours or more)

Florida Resident

1. **Independent Student:**

24 consecutive months residence in Florida prior to first day of semester of aid received.

2. **Dependent:**

24 consecutive months residence in Florida prior to first day of semester of aid received. Parents' address prevails for dependent students. A dependent student cannot be a Florida resident if parents' address is out-of-state.

3. **Definitions:**

Residency. The legal status which a person acquires as the result of establishment of a domicile other than for temporary absences. However, any domicile established solely or primarily for the purpose of obtaining an education or of obtaining financial aid from the state shall not constitute residency.

Domicile. A person's fixed permanent and principal home.

*FAC Rules 6A-20.001 to 6A-20.010

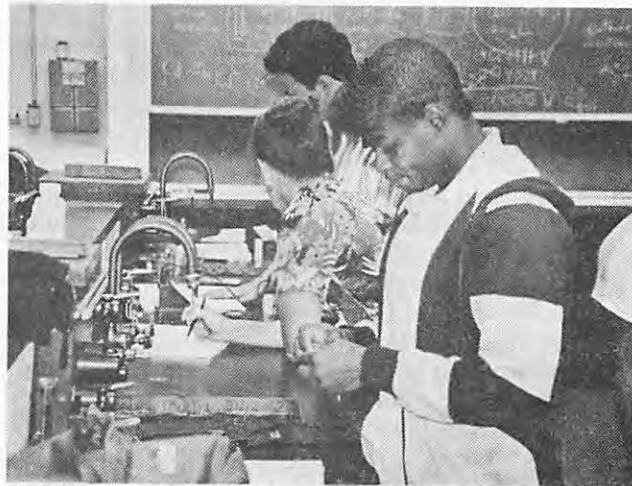

CHEMISTRY represents a challenge.

4. Satisfactory Academic Progress

- a. Must have 2.0 or higher grade point average for all previous college work.
- b. Renewals of state aid: must have 2.0 or better each term while aid is being received except a less than 2.0 may conditionally be continued on aid program for **one semester only**.
- c. Must have earned 24 hours of a planned credit program of study during the terms of the academic year in which aid was received.

5. CLAST Requirements

- a. In the semester in which a student has completed or will complete 60 semester hours credit applicable to an AA degree he/she must have passing scores on the College Level Academic Skills Test (CLAST).
- b. A transfer student from a non-CLAST college or university must take CLAST no later than the semester at Okaloosa-Walton Community College in which 60 semester hours applicable to an AA degree has been or will be completed.



THEATRE STUDENTS erect an original Broadway set for Arsenic and Old Lace presented to the college.



TYPICAL OF COLLEGE NIGHT exhibits was this one from the University of Alabama where catalogs and other promotional material are available to college bound students.

6. Selective Service Registration Requirement

Male students enrolled at a Florida postsecondary educational institution (OWCC), shall show proof of registration with the Selective Service System.

7. No Default Statement

Not be in default on federal or state loan programs, Pell Grant, State Grant, or Supplemental Education Opportunity Grant unless satisfactory arrangements to repay the loan or grant have been made.

8. Student Financial Need

Institutions shall insure that the state student assistance grant, in combination with all other student resources, does not exceed the net computed financial need of the student.

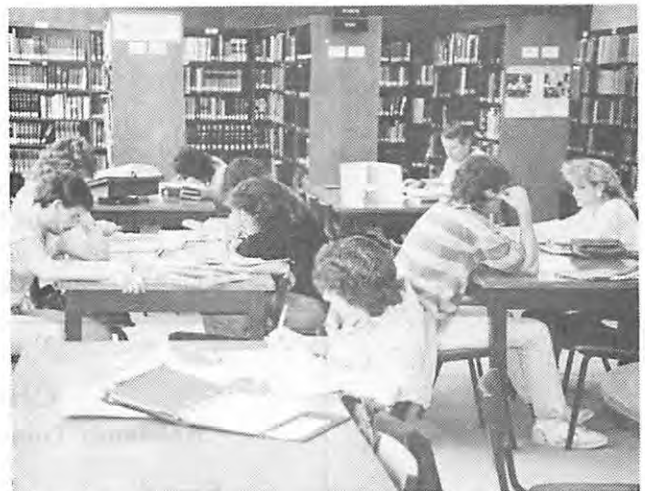

THE OWCC LIBRARY provides an excellent atmosphere for study and houses more than 75,000 volumes.

STANDARDS OF PROGRESS FOR FEDERAL FINANCIAL AID ELIGIBILITY

CHART A Eligible Full-Time Student Evaluation	
Number of Full-Time Semesters Enrolled	Required Cumulative Hours
1	7
2	14
3	21
4	27
5	35
6	42
7	49
8	56
9	64

CHART B Eligible Part-Time Student Evaluation	
Number of Part-Time Semesters Enrolled	Required Cumulative Hours
1	3
2	6
3	9
4	12
5	15
6	18
7	21
8	24
9	28
10	32
11	36
12	40
13	44
14	48
15	52
16	56
17	60
18	64

FORMULA

Cumulative Number of Required Full-Time Enrollment Hours (Chart A)
 + Cumulative Number of Required Part-Time Enrollment Hours (Chart B)
 = Total Number of Required Cumulative Hours for Satisfactory Incremental Progress

CHART C Academic Good Standing Criteria	
Earned Semester Hours	Grade Point Average
0-11	N/A
12-23	1.50
24-35	1.70
36-47	1.80
48-59	1.90
60-64	2.00
64 +	2.00

ADDITIONAL INFORMATION AND REQUIREMENTS

Satisfactory and Incremental Progress.

Students must have earned a certain number of cumulative hours semester-by-semester to maintain satisfactory progress. Fewer hours are required per semester during the early semesters because those times serve as a crucial period of adjustment for most students. While incremental progress will be checked at the end of each semester and efforts made to warn the student if not making satisfactory progress, enforced denial of using financial aid will occur only at the end of each academic year (i.e. the end of summer). A schedule designating the required number of cumulative hours semester-by-semester for full and part-time students is shown in Charts A and B on page 24.

Academic Good Standing. When admitted to Okaloosa-Walton Community College as a "first-time-in-college student," a student is construed to have financial aid eligibility. Once enrolled in coursework, or if a transfer student, a student's cumulative GPA will be used as the key indicator of academic good standing. To continue to receive financial aid, recipients must earn a cumulative GPA which relates to the cumulative number of earned semester hours. The required cumulative GPA which relates to cumulative hours earned is shown in Chart C on page 24.

Financial Aid Suspension. Students who do not meet eligibility standards shall be suspended from federal financial aid until they provide evidence, in writing, that they have regained academic eligibility in accordance with the Academic Standards of Progress. Reinstatement does not guarantee the receipt of financial assistance because aid awards are made on the basis of timely completed applications, demonstrated need, and the availability of funds.

Notification. Following the spring semester, the Financial Aid Office will send a letter to all current financial aid recipients who are to be suspended. This letter is sent to students who do not meet standards of satisfactory progress or academic good standing. Suspended students will not receive financial aid for the following semester even if already enrolled. The notice will be addressed to the student's most current local address on file with the Office of the Registrar. IT SHALL BE THE RESPONSIBILITY OF THE STUDENT TO KEEP OWCC INFORMED OF A CORRECT MAILING ADDRESS AT ALL TIMES. The cost of enrollment during financial aid ineligibility must be borne by the student. Federal financial aid *will not* be available.

Reinstatement and Appeals Process. A student who loses eligibility has an opportunity to appeal through an appeal process. The appeal must be submitted to the Director of Financial Aid *in writing* by the student. Members of the Student Financial Aid committee will act as an appeals committee. The appellant is encouraged to provide documentation as necessary for determination and disposal of the case and shall fulfill all reasonable requests by the committee with reference to time of meeting, personal appearance, and supporting evidence. The committee will determine if mitigating

circumstances exist. Mitigating circumstances are defined as:

1. Death of a close relative affecting the student's academic performance.
2. Illness of the student or close family member having direct effect upon the academic record.
3. Poor past record resulting from youthful carelessness, social or psychological immaturity.
4. Special circumstances of a specific and substantial nature of a unique kind as determined by the committee.

If mitigating circumstances are found to exist, the student may be restored to satisfactory academic standing for one semester after which the general standards will apply. Further restoration to satisfactory standing may occur *only* if progress during the intervening semester(s) clearly gives sound, documented evidence of progress. Progress must be acceptable to the appeals committee.

Incompletes, Withdrawals. A student who carries a recorded "Incomplete" at the time of evaluation will be given a one-semester grace period when meeting eligibility requirements and Standards of Progress. The student's record will be held in suspense, and a re-evaluation will be made at the end of the next semester for which the student is enrolled. If the "I" has not been changed to a letter grade at the time of re-evaluation and the Registrar's Office has not been notified of an extension, the student will be assigned a grade of "F." Such a grade may readily contribute to suspension of financial aid eligibility.

Repeated Courses. A course in which an "N", "D", or "F" has been earned may be repeated for credit. A student may not repeat a course for credit in which a grade of "C" or better was earned (unless permission of the Dean of Instruction is obtained). The student may improve a grade in a course and the repeat credit(s) will be included in the total number of credits when determining enrollment status. The student must be making satisfactory progress.

Remedial Courses. OWCC includes remedial courses where necessary when determining a student's enrollment status. Admission placement testing requirements will determine if remedial courses are needed in a student's degree program.



THE OWCC jogging trail provides an excellent setting for aerobics runners.

Verification. The United States Department of Education randomly flags a student's Student Aid Report (SAR) for verification. Students selected must provide all of the necessary documents needed for this process (i.e. income tax forms, W-2 forms). OWCC's Financial Aid Office retains the right to request supporting documents it deems necessary from any student. For this reason, OWCC suggests that students do not file any financial aid applications until the tax forms for the family are complete and correct. Inaccurate estimates of income and taxes paid may require extensive processing delays and verification of corrected data. Students are urged to retain a copy of relevant U.S. income tax forms. All financial information must be correct. Penalties or delays may occur if the data is incorrect or incomplete.

Documentation. Unmarried students less than 24 years old who claim independent status are automatically selected for a documentation. Supporting documents must be provided to the Financial Aid Office prior to any disbursement of funds. Students married during either the base or award years might also require this process. OWCC's Financial Aid Office retains the right to document any student it deems necessary.

Selective Service. Males born on or after January 1, 1960, must have registered with the Selective Service System to receive federal or state aid. If you are age 18 or older and have not registered, you may do so at the nearest U.S. Post Office. A Selective Service registration statement will appear on the federal *Student Aid Report* (SAR) and on OWCC's student financial aid award letter. Males must have met this requirement prior to disbursement of student financial aid.

CONTRACT SERVICES BY STUDENTS

Any student receiving a contracted services commitment from Okaloosa-Walton Community College will, **as a minimum**, be in good standing. Additional criteria may be required. A non-discriminatory statement shall be incorporated into **all** requests for employment of students, including contracted services. Each and every student retained under contracted services will be



OKALOOSA COUNTY high school volleyball teams use college facilities for a tournament.

selected and assigned jobs, and otherwise treated without regard to race, sex, age, national origin, religion, marital status or handicap. Reasonable accommodation will be provided for qualified handicapped students. If a student defaults, they will be paid only for services provided.

1. **Food Service Trainee:** Each Commercial Food Service Trainee is eligible for contracted services of \$75 per semester in each 6-hour Commercial Food Service **laboratory** course in which duly enrolled in pursuit of an Associate Degree or Certificate in Commercial Foods. Each trainee will be obligated to a training assignment in the food services area for the number of contact hours per week specified in the laboratory portion of each course and shall be entitled to one specified meal per day. The Commercial Foods Manager will notify the Comptroller as to trainees successfully completing the program at the end of each semester.
2. **Student Assistants:** Student Assistants shall be paid on a contracted services basis not to exceed \$300 per semester for a student enrolling for 15-semester hours or more and not less than \$240 for a student enrolling in 12-semester hours in a given semester provided that the contract is totally fulfilled. The Comptroller will pro-rate payment to student assistants according to semester hours taken and portion of semester worked.

A maximum of 40 one-semester student assistantships may be granted to full-time students who are residents of the Okaloosa-Walton Community College District upon joint recommendation of a Department Chair or of an organization Unit Head. No more than 50% of these scholarships shall be available in the fall semester, 40% in the spring semester and 10% in the summer semester.

Each Student Assistant will work ten (10) hours per week under the supervision of a department chair or an administrator to whom assigned. Duty schedule(s) and time sheets are required. A student who falls below a cumulative 2.0 grade point average is not eligible for a student assistantship.

The selection of these students complies with provisions of the Florida Educational Equity Act and in no way discriminates on the basis of race, sex, age, national origin, religion, marital status, or handicap.

No student will be a student assistant for more than two semesters per calendar year.

3. **Student Activity Workers:** Upon recommendation of the Director of Student Services and the approval of the President, student activity workers may be retained to perform contracted services in connection with implementing specific student activities (e.g., lighting, sound, photo lab workers) at a rate not to exceed \$300 per 16-week semester or \$240 per 12-week semester. Such workers shall normally be full-time students (minimum 12 semester hours) and be obligated to 10-15 hours per week on the average.

No student will be a student activity worker for more than two semesters per calendar year.

4. **Student Publications Editor:** Upon recommendation by the Information Services Officer and the Director of Student Services, a student may be retained to serve as Editor on college publications (e.g., *Raider Review*, *Campus Chronicles*). The maximum amount to be paid to the student publications editor in 1988-89 shall be \$300 per semester.

Appointments shall be semester-by-semester for fall and spring semester, **only**, through submittal of a Purchase Requisition, with payment only at the end of the semester upon documentation by the Information Services Officer and the Director of Student Services of complete fulfillment of obligations. At no time shall editors be appointed for more than two semesters per calendar year.

The **contracted services payment** shall be pro-rated according to semester hours taken and portion of semester completed if the student fails to complete the semester.

At such time as the Information Services officer and the Director of Student Services, jointly, shall judge the obligation of the student not have been met to their satisfaction, the **contracted service** shall be discounted as of that date and consequent financial adjustments made by recommendation of the Comptroller and approval of the President.

No student will be a student publications editor for more than two semesters per calendar year.

VETERANS' BENEFITS

The federal government has programs which provide some financial assistance for veterans and their dependents. These programs are described briefly on page 39. Assistance and information may be obtained from the campus Registrar's Office or from the Veterans Administration, Regional Office, P.O. Box 1437, St. Petersburg, Florida 33731.

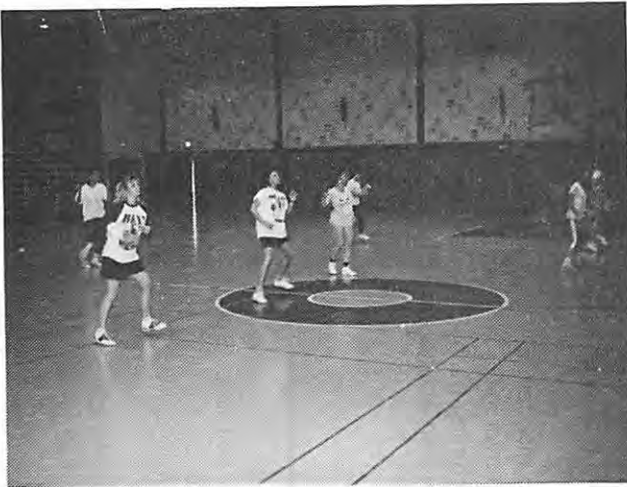

STAYING SLIM. These young ladies are participating in an Aerobics dance class offered by the college at several locations each semester.



VINCE BRUNER, future state senator, visits the campus to meet students and faculty.



VOCATIONAL TEACHERS are addressed by Gail Kaltz, Chairman, OWCC Industrial/Technical Dept., at a special gathering held at OWCC for vocational teachers from Okaloosa and Walton counties.



PHI LAMBDA ALPHA, Arts and Humanities Club, hosted Kim Luckie and Savage Bell who presented dramatic interpretations as part of the program.

Name of Program	Funding Source	Qualifications	Min/Max Awards	Application Procedures	Applicant Priority Deadlines	Special Information
Pell Grant	Federal	Available to students in a program of study, who are citizens or eligible non-citizens; must not have a baccalaureate degree, must follow standards of academic progress and incremental progress, minimum part-time student.	\$200-\$2300 (estimated) per year	1989-90 FFS	Fall-4/1/89 Spring-10/1/89 Summer-2/1/90	Foundation Aid Program. Basic Component of most Student Financial Aid. Very limited; generally goes to those applicants with a very high need. Extra \$2.00 charge on the FFS application for this program.
Supplemental Educational Opportunity Grant (SEOG)	Federal	Applicant must have a high need and be a Pell Grant recipient.	\$100-\$1000 per year	1989-90 FFS	4/1/89	
Florida Student Assistance Grant (FSAG)	State	Applicant must be a full-time student, who is a resident of Florida for at least two years and demonstrates a need.	\$100-\$1000 per year	1989-90 FFS	4/15/89	
Stafford Student Loan (formerly GSL)	Federal	Available to students in a program of study. Must be enrolled at least half-time. Student cannot borrow more than the cost of attendance less resources and any other financial aid received.	\$200-\$2625 per year	1989-90 FFS and Loan application	At least 12 weeks before the end of the semester the student plans to attend.	Current interest rate is 8%. Six month grace period after student stops attending school.
Okaloosa-Walton Community College Short-Term Loan	OWCC	Available to students who maintain a minimum 2.0 grade point average (returning students) or incoming freshmen who have a need and an ability to repay the loan.	Up to \$400 per semester	OWCC Student Loan Contract	Normally completed during registration	Repayment is distributed in three equal payments during the semester on specified dates. (See Financial Section of the Catalog for collection procedures.)
College Work Study Program (CWSP)	Federal	Applicant must be at least half-time with a high financial need.	\$500-\$2000 per year	1989-90 FFS	4/1/89	All jobs are on campus. Most positions are either 10, 15 or 20 hours per week. Pay is federal minimum wage.
Public School Work Program (PSWEP)	State	Applicant must be at least half-time with a high financial need.	\$50-\$2000 per year	1989-90 FFS	4/1/89	Students work as tutors and mentors to academically disadvantaged students.

G R A N T S

L O A N S

W O R K

Honors Scholarship	OWCC	Applicant must be class Valedictorian or Salutatorian from one of OWCC's nine area public high schools (scholarship passes to next ranked student in class).	Full Tuition & Fees for 64 semester hours	OWCC Scholarship Application	4/1/89	High School Principals and Senior Counselor's Recommendations. Two scholarships per high school.
Minority Honors Scholarship	OWCC	Applicant is top Black Student academically from each of OWCC's nine area public high schools (scholarship passes to next ranked student in class).	Full Tuition & Fees for 64 semester hours	OWCC Scholarship Application	4/1/89	High School Principals and Senior Counselor's Recommendations. One scholarship per high school.
Fine & Performing Arts Scholarship	OWCC	Auditions held each Spring by Fine & Performing Arts Department Chairman	Full Tuition up to 16 semester hours	OWCC Scholarship Application	Open	High School Choir and/or Band Director's Recommendations. This scholarship can be renewed.
Leadership Award	OWCC	Each area high school receives a minimum of three and a maximum of eight per school depending on senior class size.	\$200 Fall Semester	OWCC	4/1/89	High School Principal's and Senior Counselor's Recommendations.
Directed Work Study Scholarship	OWCC	Recommendation of Department Chair and approval of Dean of Instruction.	No financial award. Fees paid by scholarship \$20.00	Directed Work Study Application	NLT Last day of semester registration.	One semester hour of credit per semester can be earned.
Student Government Association (SGA) President	OWCC	Student elected to the office of President of Student Government Association.	Full tuition for one year up to \$640	OWCC Scholarship Application	When Elected to Office	Contact Student Services for more information.
Regional Science and Engineering Fair/OWCC Scholarship	OWCC	Awarded to four Senior Grand Award winners and Senior Alternate selected yearly at area Science Fair.	Full tuition & fees for 64 semester	OWCC Scholarship application	Annual Science Fair	Must attend OWCC immediately upon high school graduation.
Designated & Undesignated Donor Scholarship	Local Community Organizations	Various selection criteria established by the donors.	Varies	Applications provided by donors	Dates set by donors	A large number of scholarships are available. Best source of applications is OWCC's Financial Aid Office, High School Guidance Office and local organizations.
Florida Academic Scholar's Program	State	Outstanding Florida high school graduates, minimum two year Florida residency, 3.5 grade point average, SAT scores 1200 or ACT scores 28 or National Merit.	\$1000-\$2500 per year	Special State Application	4/15/89	Area high school Senior Counselor must submit Application.
"Chappie" James Most Promising Teacher Scholarship Loan Program	State	One TOP graduating senior from each public secondary school in Florida who attends college in the state of Florida.	Up to \$4000 per year	Special State Application	4/15/89	Must teach in the State of Florida a minimum number of years equal to the number of years the scholarship was received.

S C H O L A R S H I P S

INSTRUCTIONAL PROGRAMS

STANDARDS AND REGULATIONS



AN ART STUDENT burnishes an aluminum casting made by making a styrofoam model of a cat, burying it in wet sand and then pouring hot metal which melted the styrofoam.



DIGNITARIES and guest speaker, Bolley "Bo" Johnson, right, at the 1988 graduation.

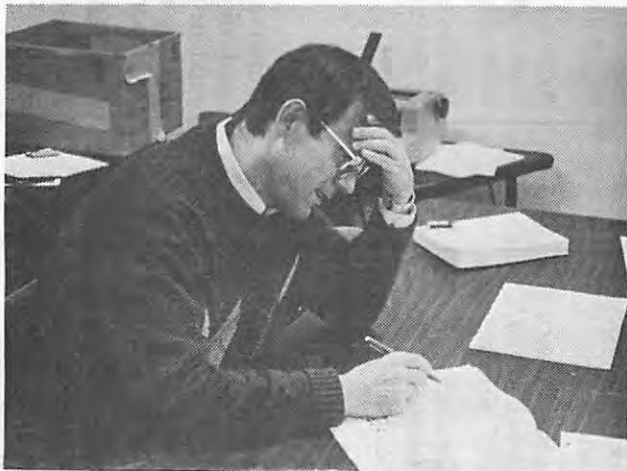

HEADACHE? Ed Scofield, Social Science Instructor, thinking about his duties as Director of the Self-Study Committee preparing for the renewal of the college's accreditation with the Southern Association of Colleges and Schools.

FULL-TIME AND PART-TIME STATUS

Students are considered to be full-time or part-time according to the course load at the time of registration; the designation will not be changed after the close of registration. A student enrolled for 12 or more semester hours, or 24 or more contact hours per week in non-credit courses, is considered to be a full-time student.

AUDIT STATUS

Students registering in a college-credit course on a "not-for-credit" basis will be considered as audit students and their records will be marked accordingly. An "X" grade will be placed on the permanent record, and no hours attempted or quality points will be recorded. Occupational courses cannot be taken on an audit basis.

Examinations for audit students are not required; however, audit students are expected to attend classes on the same basis as credit students and to meet all the requirements of the course with the exception of examinations. Excessive absences for audit students are treated the same as for credit students. The instructor may recommend to the Dean of Instruction that the student be dropped from the class with a grade of "W."

Fees are the same for both credit and audit students.

Students may register for a class on an "Audit" basis at anytime during the regular registration period or change to "Audit" status prior to the date stated in the college calendar as the last day for dropping classes. "Audit" students must meet the same admission requirements as college-credit students.

Audit students may not change to credit status following the expiration of the Drop/Add period specified for each semester in the college calendar.

CHANGE OF SCHEDULE

Changes in courses or sections may be made during the Drop/Add period specified in the college calendar and/or in the Schedule of Classes each semester. Any such changes shall be accomplished by completion and processing of required forms to the Registrar's Office and off-campus centers.

CLASS ATTENDANCE

Students are expected to attend all of their scheduled classes. The effect of absences upon grades is determined by the instructor who may recommend to the Dean of Instruction a withdrawal grade whenever absences become excessive. Arranging to make up work missed because of legitimate class absence is the responsibility of the student in cooperation with the instructor(s). Instructors shall not, however, authorize major blocks of class absences (e.g., 25% or more of the total class hours) without approval of the Department Chair and the Dean of Instruction.

Attendance is recorded by the instructor who will report immediately to the Registrar's Office each student who has accumulated three consecutive day class absences or two (2) consecutive evening absences from class or three absences in a month. Further, each time a student has been tardy three times in a class, it will count as one absence. Each set of consecutive absences will be reported. **Veterans** are subject to the same attendance requirements as all other students (see page 39).

EXAMINATIONS AND GRADES

Final examinations are held at the end of each semester and must be taken at the scheduled time. If a student is absent from a final examination because of substantive illness or other approved reasons, a late examination will be given.

Letter grades will be assigned as follows: A-Excellent; B-Good; C-Average; D-Passing; F-Failing; I-Incomplete; V-Deferred Incomplete; S-Satisfactory; U-Unsatisfactory; N-No Grade (nonpunitive); and X-Audit.

Grade points per semester hour are as follows: A-4; B-3; C-2; D-1; and F-0. Grades of "I-Incomplete" will change to "F-Failing" at the end of the next 16-week semester following the issuance of the grade if work is not made up during that period of time. The "I" or "V" will carry "O" grade points until it is made up. "S's," "U's," "N's," and "X's" carry no grade points or credits. No grades or transcripts will be released to or for students with incomplete records or outstanding fees, loans, or fines.

INCOMPLETE GRADES

A grade of "I" may be given when a student is unable to complete the required work because of clearly documented extenuating circumstances **and only** if the student has a reasonable chance of making a passing grade. The instructor files with the department chair and with the student concerned an outline of the work that must be completed with an estimate of the student's grade standing for work already completed during the semester. Work for the removal of the "I" must be completed prior to the END OF THE FINAL EXAM

PERIOD in the next 16-week semester immediately following. The grade will revert to an "F" on the official transcript if not removed by that time. A grade of "I" shall not be given as a mid-term progress grade.

A deferred incomplete grade of "V" may be assigned by the teacher when approved absences preclude satisfactory course completion by the end of the next 16-week semester of enrollment.

NON-PUNITIVE ("N") GRADES

"N" grades may be awarded for modular-type courses only. For those courses in which college credits may be earned, the "N" will only be awarded at the end of the term in which a student could not complete the modular requirements necessary to earn a "standard" letter grade.

A "I" grade may be awarded if, by mutual agreement between student and instructor, the student understands and assumes the responsibility for completing all modules by the end of the next term (mandatory completion time for "I" grades). A grade of "V" may be awarded according to conditions stated above.

If a student has not completed a course in which the student received an "N" grade by the end of the second semester of enrollment in that course, the student will receive no more than a "C" for that course in any subsequent semester. Re-enrollment and payment of all necessary fees is required to be eligible in a following semester to earn a letter grade and the appropriate credits in a course in which an "N" has been awarded.

At the present time, only the following courses are approved for granting "N" grades: College Preparatory Mathematics; College Preparatory Algebra; College Preparatory Reading; College Preparatory English, and IEA 0131, Adult General Education/Vocational Preparatory.



GENE BENVENUTTI and the Registrar's staff.

SATISFACTORY/ UNSATISFACTORY ("S" AND "U") GRADES

"S" and "U" grades shall be awarded to students in all college preparatory and non-credit classes except where A-F system grades are required for high school credits or for other justifiable reasons. Non-credit courses in which in the issuance of the required grades other than S or U are to occur shall be approved in advance, individually, by the Dean of Instruction based on appropriate written justification.

WITHDRAWALS

1. A grade of "W" (with zero hours attempted) will be entered on the student's permanent record card for a properly executed withdrawal through the Registrar's Office. Withdrawals must take place before the end of the week following the due date for mid-term grades in the fall and spring semester, and the end of the fourth week for Terms I and II but after the drop/add period indicated in the college calendar. Withdrawals are also authorized for 8-week and other short classes up to the third college workday beyond the class mid-point.
2. WITHDRAWALS may be permitted after the end of the tenth week for the fall and spring semesters, the seventh week for the summer semester, and the fourth week for Term I and based on extenuating, justifiable reasons. If the student feels a grade of "W" is appropriate, the student will be responsible for validation of the specific extenuating circumstances and for filing a written request with the Registrar for referral to the Dean of Instruction for appropriate action.

A student withdrawing from the college or dropping any course must file an official drop/add slip in the Office of the Registrar and the Comptroller's Office to avoid receiving an automatic grade of "F" in the course(s) concerned. (See paragraphs 1 and 2, above, for withdrawal without "F" grades).

ACADEMIC STANDING

Each college program has appropriate standards ranging from recognition of excellence to discontinuance for inadequate progress toward the respective program goals. These standards apply to full-time and part-time college-credit students. (Alternative non-credit programming and adult education opportunities are available for persons who do not choose to continue in degree or credit certificate programs.) For those who enroll as part-time college-credit students (less than twelve (12) cumulative semester hours) the cumulative grade-point average will not be computed for honors or substan-

dard academic performance until the student has attempted a minimum of twelve (12) cumulative semester hours. It will be computed each twelve (12) hours thereafter.

Superior Scholastic Performance. When the quality of a student's work is superior, the college is pleased to honor such work through recognition as follows:

PRESIDENT'S LIST. Full-time students (or part-time students for each cumulative twelve hours) who make a grade-point average of 3.80-4.00 in any semester are placed on the President's list.

DEAN'S LIST. Full-time students (or part-time students for each cumulative twelve hours) who make a grade-point average of 3.50-3.79 are placed on the Dean's list.

HONORS AND HIGH HONORS. At the time of graduation, a student's total academic record is reviewed to determine High Honors (3.80-4.00) and Honors (3.50-3.79). For students to graduate with this distinction, they must have earned 24 or more hours of credit at OWCC and must have attained these same standards on all work done at OWCC as well as any cumulative academic work from prior institutions of higher education.

Good Standing. A student is considered in good academic standing so long as the student maintains the appropriate cumulative grade-point average (GPA) specified in the following schedule for satisfactory academic progress and while on academic probation. Students on academic suspension are not considered to be in good standing:

Credit Hours Attempted	Minimum Required GPA
12	1.50
24	1.70
36	1.80
48	1.90
60 or over	2.00

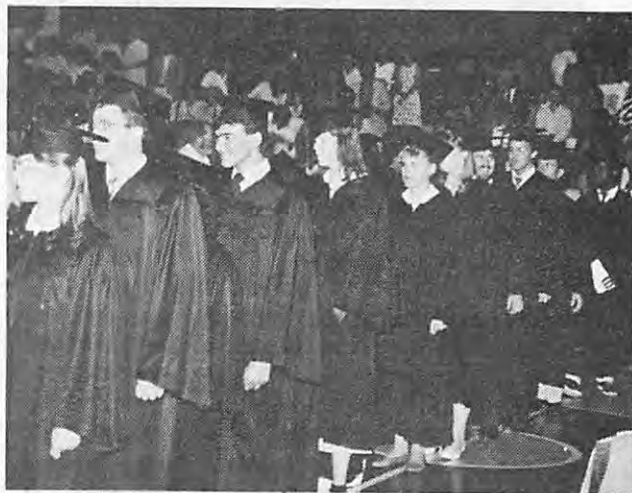

THE GRADUATING CLASS OF 1988 in their processional.

Substandard Academic Performance. When the quality of a student's work is substandard the college is obligated to initiate restrictions relative to further studies and to apprise that student of the serious nature of his/her academic status. For these reasons, the following regulations pertain with respect to academic probation and suspension.

Academic Probation. Any student who fails to maintain the appropriate grade-point average specified in the schedule listed above under "Good Standing" shall be placed on Academic Probation. This requirement is based on the fact that a student, to graduate from this college, must attain a cumulative grade-point average of not less than 2.0 ("C") on all college-level work attempted — including all work at Okaloosa-Walton Community College plus work which is transferred from any previously attended institutions of higher education. All work at previous institutions of higher education will be counted, **not** just selected courses. The college will notify students of any shortages of grade points with respect to these standards. The record of any student who fails to meet these standards shall be stamped "Academic Probation."

IT IS STRONGLY RECOMMENDED THAT A STUDENT ON ACADEMIC PROBATION CONTACT A FACULTY ADVISOR OR A COUNSELOR WITH REGARD TO ENROLLING IN DEVELOPMENTAL, COLLEGE PREPARATORY, COMPENSATORY, OR SPECIFIED NON-CREDIT COURSES TO CORRECT AREAS OF DEFICIENCY.

To be removed from academic probation, a student must increase the cumulative grade-point average for all work attempted to at least the level specified in the Schedule of Satisfactory Academic Progress.

Academic Suspension. A student who has been on academic probation two consecutive semesters shall be considered to be making unsatisfactory progress and will be suspended for a minimum of one semester. For the student whose record necessitates academic suspension, the entry "Academic Suspension for a Minimum of One Semester" shall be stamped on the permanent record.

Any full-time student (or part-time student who has accumulated 12 credits) who fails all courses in academic work shall be suspended for a minimum of one semester.

IT IS STRONGLY RECOMMENDED THAT A STUDENT PETITION FOR ENROLLMENT IN CERTAIN AUTHORIZED DEVELOPMENTAL, COLLEGE PREPARATORY, VOCATIONAL PREPARATORY, OR SPECIFIED NON-CREDIT COURSES DURING THE SEMESTER OF SUSPENSION TO STRENGTHEN THE AREAS OF DEFICIENCY. ALSO, SUCH STUDENTS SHOULD SEEK COUNSELING ASSISTANCE REGARDING THE APPROPRIATENESS OF THEIR OBJECTIVES.

Readmission. To be readmitted to Okaloosa-Walton Community College following academic suspension, a standard readmission form needs to be submitted to the Director of Admissions. (The form is available in the Admissions and Registration Office on the Niceville campus, at the OWCC Egin and Hurlburt Offices, at the OWCC/UWF Fort Walton Beach Center in DeFuniak Springs.) Approval of such requests is most frequently granted after one semester out of college unless the prognosis for academic success is especially poor or there are conditions other than academic status involved. Students re-entering after suspension will be placed on academic probation and will be subject to the rules pertaining to substandard academic performance.

Academic History Forgiveness Policy. Should a student whose credits are ten or more years old desire to seek relief from the effect of those grades upon his/her current record at OWCC, a written request for such relief may be made through the Office of the Registrar. Should favorable action be taken, the courses and grades will continue on the face of the permanent record, but relief will be in not counting such grades and hours in grade-point computations. The action of the college upon such a petition shall be final. No credit passed or failed that is ten (10) or more years old will be counted if such relief is granted. Such courses may be a sound basis for seeking contemporary credit through comprehensive examinations.



A STUDENT studies a slide showing bone structure as Ross Hamilton, Biology Instructor, watches.

Repeated Courses.* For any course repeated, whether at OWCC or elsewhere, only credit from the last attempt will be used in the computation of the final grade-point average (GPA) and for meeting degree requirements. Students should be aware that repeating a course results in an adjusted grade-point average** and that such an adjustment may not be accepted by some private colleges and universities outside of Florida. Repeated courses are honored by state universities in Florida upon completion of the AA Degree.

Foreign Language Requirements for Entry Into Upper Level Florida Universities. Effective August 1, 1989, according to requirements of the Florida Board of Regents, new applicants to any of the state universities must have completed two years of one foreign language in high school. Eight to ten semester credits in one foreign language at the postsecondary level will also meet the minimum entry requirement. **EXCEPTIONS:** (1) earned a high school diploma prior to August 1, 1987; (2) received an Associate of Arts degree prior to September 1, 1987; or (3) enrolled full-time in a program of studies leading to an Associate of Arts degree from a Florida community college, maintaining continuous full-time enrollment until admitted to a university.

Okaloosa-Walton Community College offers the necessary instruction in French, German, and Spanish to meet the provisions of the SUS admission requirements. Students are encouraged to enroll for the courses which they will need in order to be fully admitted when ready to transfer.

COLLEGE LEVEL ACADEMIC SKILLS TEST

Florida has developed a test of college-level communication and computation skills entitled **College Level Academic Skills Test (CLAST)**. The CLAST tests communication and computation skills judged by state university and community college faculty to be associated with successful performance in higher education. The test is administered to all students seeking an Associate of Arts degree. It is required by Florida Statutes and by Administrative Rules of the State Board of Education.

The CLAST is administered toward the end of the sophomore year to community college students who are completing Associate of Arts degree programs or who are otherwise seeking admission to upper division programs in state universities in Florida. **Only students who pass all four (4) subtests of the CLAST can legally be awarded the Associate of Arts degree.** Only students who have passed all four (4) CLAST subtests can be unconditionally admitted to the upper divisions of the State University System.

*NOTE: Students on VA benefits should be aware that the Veterans Administration WILL NOT PAY for a repeated course in which a grade of "D" or better has been earned.

**NOTE: GPA's are NOT changed for courses repeated after a student receives an AA Degree (Per Articulation Agreement).

Without the CLAST, admission to state universities in Florida will be on a conditional basis. The student may take only a limited number of courses until all four subtests of the CLAST are passed. (Currently, students passing three out of four subtests may **enroll** for up to 36 semester hours of coursework beyond the sophomore level. They must pass the fourth subtest before being allowed to continue). The CLAST also applies to students transferring to Florida universities from private institutions in Florida and from out-of-state colleges and universities.

As required by statutes, the State Board of Education has established minimum CLAST score standards for award of the Associate of Arts degree and for admission to upper division status in state universities in Florida. (The minimum passing scores in effect from August 1, 1986, through July 31, 1989, are as follows: Reading 270, Writing 270, Computation 275, and Essay 4. After August 1, 1989, the state-adopted passing scores are scheduled to be as follows: Reading 295, Writing 295, Computation 295, and Essay 5).

A student must present scores that meet minimum standards in effect at the time he or she **initially takes the test** to meet minimum state board standards for the Associate of Arts degree or to attain upper division status in a state university.

The Director of Student Services (678-5111, ext. 327) provides information on how and when to apply to take the CLAST. The Dean of Instruction can provide a list of CLAST skills and identify where the communication and computation skills are taught in the curriculum.

THE CLAST TEST WILL BE GIVEN ON MARCH 11, 1989, AND JUNE 3, 1989. NOTICES REGARDING CLAST APPLICATION DEADLINES ARE PUBLISHED IN THE COLLEGE CALENDAR AND IN THE OWCC BULLETIN.



PREPARING students to enter the restaurant and fast foods fields is an important program offered to students at Okaloosa-Walton Community College.

REQUIREMENTS FOR GRADUATION

General requirements for graduation from Okaloosa-Walton Community College must be met by all students seeking a degree without regard to the degree to be granted. **Final responsibility for meeting the requirements for graduation rests with the student.** If the student is in doubt about course requirements, the academic advisor should be contacted before each registration. Students should check with their faculty advisor during their next to last semester to ensure all graduation requirements will be met by the end of the next semester. Participation in graduation exercises is expected.

1. Students must have a total of 64 semester hours for graduation, including a minimum of 42 semester hours of General Education courses for the Associate of Arts degree; 26 semester hours of General Education courses for the Associate of Science degree; (16 semester hours of General Education courses for the Applied Science Options). The remaining hours in each program may be taken in any one of the prescribed programs or in a planned program approved in writing by the Dean of Instruction.
2. Students must make formal application for graduation and **if seeking an AA degree, (or planning transfer with an AS degree) apply for the College Level Academic Skills Test on the proper forms** furnished by the Registrar and **must meet the deadlines** designated in the college calendar which appears in the college catalog. To receive an AA degree a student **must** pass all four (4) subtests of the CLAST.
3. Each graduate must be in attendance during the semester in which the degree is earned and must have earned no less than 15 semesters credit hours from OWCC. If a student leaves the college and later applies for a degree, the student must have met the degree requirements at the time of his/her last OWCC enrollment and must have earned 15 semester hours at OWCC. Exceptions may be granted only by special written request submitted to the Registrar and approved by the Dean of Instruction, e.g., Servicemember's Opportunity College agreements.
4. A grade-point average of not less than 2.0 ("C") must be attained on the cumulative total of all work attempted whether at OWCC or by transfer. The minimum grade-point average for all course work attempted at OWCC must be 2.0 ("C"). Any credits accepted for transfer shall be "C" work or better. "D" grades may be accepted from a regionally-accredited institution of higher education.
5. Qualification for graduation with Honors or High Honors will be computed on the total of all degree work attempted whether at OWCC or by transfer. A student shall graduate with Honors or High Honors only if the degree work done at OWCC qualifies.

6. Four (4) semester hours of Physical Education credit are required for graduation. All regularly enrolled students seeking an AA or AS degree should enroll in at least one PE course each semester until the four semester hour requirement is met.

STUDENTS EXEMPT FROM PHYSICAL EDUCATION COURSES MUST MAKE UP THE FOUR SEMESTER CREDIT HOURS BY TAKING NON-ACTIVITY PHYSICAL EDUCATION COURSES.

Exemptions are as follows:

- a. **Physical Disability:** A student with a restrictive physical disability must provide a written statement from a physician to the Physical Education Department Chair for approval. If approval is recommended, the medical statement and waiver are submitted to the Dean of Instruction for final approval. These students must take 4 semester hours of nonactivity Physical Education courses.
- b. **Age:** Students who have reached their 30th birthday are not required to enroll in Physical Education activity courses but must take 4 semester hours of non-activity Physical Education courses.
- c. **Evidence of Extreme Hardship:** Students completing requirements by attending evening classes **only** and/or part-time day students having difficulty in scheduling and/or meeting the requirements should work **directly with the Physical Education chair** for a solution to the problem, preferably during their first semester of enrollment.

Non-activity courses which meet graduation requirements for persons **exempt from Physical Education activity courses** are as follows:

- HCP 1081 - Wellness: Practice and Theory
- HSC 1400 - First Aid
- HSC 1000 - Personal and Community Health
- LEI 2330 - Camp Counseling
- LEI 1000 - Introduction to Recreation
- PET 1000 - Introduction to Physical Education
- EMS 1065 - Cardiopulmonary Resuscitation
- PEM 1100 - Fitness Concepts

CREDIT BY ALTERNATIVE MEANS

Students may earn a maximum of 45 college credits through a combination of nontraditional sources as listed below:

Advanced Placement Credits: Okaloosa-Walton Community College participates in the **Advanced Placement Program** conducted by the College Entrance Examination Board, which provides 13 college-level, advanced placement examinations. Okaloosa-Walton Community College allows a maximum of 15 semester hours credit for scores of 3, 4, and 5, and allows advanced placement **without credit** for scores of 2 upon recommendation of the department concerned.

Advanced Placement Tests may be taken at participating high schools or centers. A qualified student may make a request and pay the required fees to the College Entrance Examination Board, Educational Testing Service, Princeton, New Jersey, to make arrangement to have the test or tests sent to and administered by the Coordinator of Testing at OWCC. Information bulletins are available from the Education Testing Service upon request.

CLEP General Examination: Students may earn up to 30 semester hours of credit by passing the College-Level General Examinations at the national 50th percentile or better based upon the combined Male/Female Sophomore Norms. Students may not attempt credit by examination if they have earned six or more semester credits with a grade of "C" or better in courses whose content includes materials similar to the materials to be covered in the test. This rule also applies to courses taken at the upper level in a senior university as well as the junior college level courses. If a student has earned fewer than six semester credits in such courses, they will be awarded the difference between the number of semester hours earned and the six semester hours. Students must take the 90-minute examinations. In addition, the English portion requires the written essay be taken in order for credit to be awarded.

CLEP credits for mathematics and English: CLEP credits awarded fall semester 1982 or later and based on general and subject examinations in English and humanities will be accepted as elective credit. This elective credit can be used toward fulfillment of the English and humanities requirements at OWCC when the student satisfies the 6,000 word writing requirement mandated for English and humanities courses by State Board Rule 6A-10.030. The student can satisfy this rule by enrolling in ENG 1001 Research Papers, one semester hour (one enrollment for each 3 semester hours awarded in English and humanities); a grade of "C" or higher must be earned in each enrollment in the Research Papers courses to satisfy the general education writing requirement. This course may be repeated as needed to fulfill the total writing requirement.

In mathematics, students will be able to receive credit for Introductory College Algebra through the general examination. For Pre-Calculus Algebra or higher, credits are awarded on the basis of the subject examination only.

Comprehensive Examination for Credit in Designated Courses: Students who are admitted to the college may be granted credit in designated courses based on knowledge or ability as measured by an examination in the area in which credit is being sought. Designated courses that may be completed through a Comprehensive Examination are on file in the Dean of Instruction's office.

To be eligible for credit by Comprehensive Course Examination the student must:

1. Be admitted to OWCC.
2. Complete necessary application for Comprehensive Course Examination form, securing the signature of the appropriate department chair (setting date for examination) and the Dean of Instruction.

3. After Item 2, present form to Comptroller's office and pay the Comprehensive Examination Testing Fee (100 percent of registration/tuition fee for course, excluding lab fee), returning form after payment of fee to the Dean of Instruction. The Comprehensive Examination Testing Fee may be paid anytime after the end of late registration through the mid-point of the semester, or as approved by the Dean of Instruction upon written request from the student and department chair. (Deadline date for payment of the Comprehensive Examination Testing Fee is published in the class schedule each semester.)
4. Complete the examination on date as scheduled. Examination date must be within two weeks following the deadline for application for taking comprehensive examinations. (The deadline date for application for Comprehensive Examination and payment of examination and testing fee is published in the college calendar and in the class schedule each semester.)
5. Credits will be awarded for passing grades earned on comprehensive examinations. (See footnotes on the AA degree General Education page for certain minimum grade restrictions.)

Comprehensive Course Examinations will be administered by the Department Chair. A Comprehensive Course Examination in a particular course may not be taken more than one time for a designated course.

Credit awarded by Comprehensive Course Examination will become part of a student's permanent record and will be posted to the student's transcript with the appropriate grade if all fees are paid within deadlines stated.

No more than 45 semester hours of nontraditional credit may be earned through this means or any combination of sources (i.e., CLEP, military experience, etc.).



RON WALLS, Electronics Instructor, explains the workings of a robot to a Chilean Exchange Group of businessmen and professionals touring the college as guests of the local Rotary Club.

Correspondence Course Credits: Up to nine semester hours of credit for correspondence and/or extension courses may be transferred from a college or university accredited by the appropriate regional accrediting association. These hours may include, but not be in addition to, the credits available through the Servicemember's Opportunity College Program.

Competency Testing: The AS degree at OWCC requires 38 semester hours in a specialization. The 30 semester hours that may be received through testing may not apply toward the last 8 hours for the AS or the last 18 hours for the Applied Science Options normally taken by students enrolling for all courses in their program at OWCC. Students requested credit through competency testing will prepare a program planning form in cooperation with the appropriate department chair or program advisor to select the general education courses and the final occupational credits required for the degree (64 semester hours, total).

1. **Departmental Competency Testing:** Students who have completed a diploma or certificate from an accredited vocational or technical school at less than the college level may receive up to 12 semester hours of credit in a related vocational program at OWCC. Credit is awarded based on the student's performance on departmental competency tests and the recommendation of the department chair to the Dean of Instruction. There is no charge for the competency tests.

2. **Credit for Earned Vocational Certificates.** Students who complete a vocational school certificate program which is contained in an approved agreement with the college will receive up to a maximum of 36 semester credits applicable toward an AS Applied Science Option degree. Such programs must be included in a formal written activities agreement between the college and the vocational school. OWCC currently has an agreement with the School Board of Okaloosa County/Bay Area Vocational School to award credit as follows:

OWCC AS/AAS Programs

AC/Heating/Refrigeration	36
Automotive Mechanics	36
Commercial Food Service	24
Electronics Technology	15
Welding Technology	15

Bay Area Certificate Program Max Credit

AC/Heating/Refrigeration	36
Automotive Mechanics	36
Food Production	24
Industrial Electronics	15
Welding	15

3. **Occupational Competency Testing:** Students with extensive on-the-job work experience and/or other non-certified training may receive 30 semester hours credit at OWCC upon successful completion of occupational competency examinations as administered by the Occupational Testing Center at the University of South Florida, Tampa. Such credits will be awarded in all curricula where OWCC offers AS degrees, contingent upon the person completing the remaining credits at

OKALOOSA-WALTON COMMUNITY COLLEGE which are required for program completion.

Who may apply:

Persons who are currently employed as industrial-technical instructors, students who are pursuing fulfillment of their first 64 semester hours of college-level studies leading toward an industrial-technical teacher education degree in the state university system, and persons who desire state certification as an instructor in industrial-technical education.

How to apply:

Applications should be submitted directly to the Occupational Testing Center, University of South Florida, FAO 226, Tampa, FL 33620. Forms, test dates, location, fees and other information should be requested from USF at the above address or call long distance (813/974-2100.)

How to receive credit:

Request the USF Testing Center to send a report of the competency exams **direct** to the Registrar at OWCC if not already enrolled; request an advisor to complete the program planning form which will specify the advanced courses required for completing the AS degree; enroll for and complete the specified courses with a "C" or higher grade average (minimum 2.0 GPA); and apply for graduation. NOTE: Competency credits will not be fulfilled until the application for graduation has been submitted and approved.

CLEP Subject Examinations: Students may earn college credits in the Subject Examinations listed below provided they have not completed a college-level degree-credit course with a "C" or better which is higher than or equivalent to the subject matter examination they plan to take.



THE RUSSIANS ARE COMING, and they did as part of a Glasnost gesture to the United States and they visited OWCC where they fielded questions about Russia and toured the campus.

SUBJECT EXAMINATIONS:

Accounting, Introduction to American Education, History of American Government, American History, American Literature, *Biology, Business Law, Introduction to Business Management, Introduction to Calculus w/Elementary Functions, Chemistry (General), College Algebra, *College Composition (w/Essay), Computer Programming Elementary Fortran IV, Educational Psychology, Macro Economics (Intro.), Micro Economics, (Intro.), Micro and Macro Economics (Intro.), Human Growth and Development, Marketing, Money and Banking, Microbiology, Psychology (General), Sociology (Intro.), Statistics, Trigonometry, Western Civilization, College French (Second, Fourth Semester), College German (Second, Fourth Semester), College Spanish (Second, Fourth Semester).

Students attempting to earn credit by examination should contact the Registrar first to determine their eligibility for credit in accordance with FAC Rule 6A-10.024. All credit awarded will be posted on the student record.

Some institutions do not award credit for CLEP Examinations. It is the student's responsibility to contact any institution to which the student expects to transfer to determine if that institution will accept CLEP transfer credits.

SERVICEMEMBER'S OPPORTUNITY COLLEGE

Okaloosa-Walton Community College subscribes to the principles of the Servicemember's Opportunity College and has established flexible policies including credits and/or course waivers based on CLEP, DANTES/USAFI, CASE Guide, and "challenge" examinations geared to the needs of active-duty service persons (maximum 45 credit hours). Active-duty personnel stationed at Eglin Air Force Base and Hurlburt Field who have earned a minimum of 15 approved degree credits from OWCC may transfer other approved credits back to OWCC from any accredited college or university to be applied toward the associate degree. Interested personnel should consult with Okaloosa-Walton Community College's educational advisor in the college's on-base office or with their Education Services Officer for complete details regarding the SOC.

Transfer Credits: Course work with a grade of "C" or above from a college or university accredited by the appropriate regional accrediting association will be accepted. A grade of "D" from properly accredited institutions of higher education will be accepted on a provisional basis. The student must bring the GPA up to a 2.0 while at OWCC. The acceptability of college courses for transfer credit at OWCC shall be at the discretion of the Registrar in conjunction with the chair of the department involved.

*Students may not receive credits for Biology or English Composition on the Subject Examination and, also, receive credit in the same areas in the General Examination.

CREDITS FOR ARMED SERVICES SCHOOLS AND MILITARY TRAINING:

Credits resulting from classroom-type instruction (i.e., excluding on-the-job training and correspondence-type courses) at U.S. Air Force Schools will be evaluated as stated on the official transcripts issued by the Community College of the Air Force. Credits for occupational and vocational-technical courses will apply only toward an AS degree or Occupational Certificate. Credits for classroom instruction from military schools other than the established academies of the U.S. Air Force, U.S. Army, U.S. Coast Guard, U.S. Marine Corps, and U.S. Navy will be evaluated by the OWCC Registrar according to the ACE Guide, DANTES/USAFI credits will be evaluated by the OWCC Registrar according to the DANTES Guide.

TRANSFERRING TO A SENIOR INSTITUTION

Those students who expect to transfer to a senior institution may obtain programming assistance by consulting a faculty advisor or counselor. Faculty advisors and counselors will gladly assist in planning and coordinating college programs to facilitate smooth transfers to senior institutions. Liaison representatives from the respective public senior universities in Florida are eager to assist OWCC students. Their names are available from the Office of the Director of Student Services or college counselors.

It is desirable that students transferring to a senior institution plan their program so that the transfer may occur at the beginning of the school year (normally in the fall). Curricula are generally offered in sequence. It is best for the student to complete the entire two-year program before transferring. Students majoring in highly specialized programs should seek programming assistance well in advance of actual transfer.

STUDENTS PLANNING ON RECEIVING AN AA DEGREE OR ON TRANSFERRING TO THE UPPER DIVISION OF A STATE UNIVERSITY IN FLORIDA MUST HAVE TAKEN THE COLLEGE-LEVEL ACADEMIC SKILLS TEST (CLAST).



LUCY WARREN and the Library staff.

VETERAN'S EDUCATIONAL BENEFITS

The college is certified for training by the State Approving Agency under the various veterans' training laws. Veterans planning to enroll at OWCC should consult with the Veterans Affairs Office well in advance of registering. The veteran must complete a special form (available in the Veterans Affairs Office) which is required by the Veterans Administration for initial certification and, there-upon, assume responsibility for all fees from his/her own resources or out of monies paid to the individual by the Veterans Administration.

Veterans are normally expected to pay all fees at registration. Because the "advanced payment" first check is sometimes delayed, it is advisable that the veteran be prepared to meet all expenses until that check is received. Veterans attending the college under Public Law 894 (disabled veterans) who have approval from the Veterans Administration will have registration fees paid directly to the college by the federal government.

For VA purposes, training time is usually computed as follows:

12 or more semester hours Full-time
9-11 semester hours 3/4-time
6-8 semester hours 1/2-time

For the summer semester and Terms I and II, training time is computed differently: The VA determines credits for summer course work each year and notifies the college accordingly. Veterans are advised to contact the Veterans Affairs Office before registering for summer semester and summer term classes to determine training status.

Any student-veteran who is absent three consecutive class sessions or school days without pre-notifying the Veterans Affairs office (and confirming that notice in writing) will be interrupted from training for pay purposes, and the Veterans Administration will be notified. The veteran who has been interrupted from training for pay purposes will have to request enrollment recertification through the Veterans Affairs office in order to request the VA payments be resumed.

A veteran who wishes to receive VA benefits should notify the OWCC Veterans Affairs Office prior to registration to expedite the request for subsistence allowance. Veterans, widows of veterans, and war orphans desiring information about benefits, requirements, and registration procedures should contact the Veterans Affairs Office.

VETERANS' FEE DEFERMENT POLICY

Any eligible veteran or other person who wishes to pursue an approved program of education or training, at Okaloosa-Walton Community College (within the meaning of Chapter 32, 34, or 35, Title 38, United States Code) and who meets the conditions stated in 240.345(2)(b) 1 shall, in first term of enrollment in any fiscal year, be granted upon request a sixty (60) day deferment for full payment of fees from the last date

to pay fees, provided the period of deferment shall not extend beyond 10 days before the end of the term.

Deferment of fee payment for eligible persons after the first enrollment period in any fiscal year is not authorized. An eligible person who can document a substantial, unique financial hardship may petition the Financial Aid Office to seek special consideration for a 60 day deferment. This must have the approval of the Director of Financial Aid, the Veterans Affairs Counselor, and the Comptroller before being committed or granted.

Under no circumstances shall any person be allowed to enroll or re-enroll at OWCC who has failed to pay any prior fee deferment.

ACADEMIC ADVISING

Faculty advisors are assigned to students to assist them with the proper courses to fulfill their program objectives. Anyone desiring to establish or to change advisors should contact the Registrar's Office in the Administration building on the Niceville campus or any of the off-campus center directors. Students may find out who their advisors are and how to contact them by checking the following locations where advisor listings are maintained.

Registrar's Office (A Bldg.)
OWCC Eglin Office, Bldg. 251
Library Circulation Desk (E Bldg.)
OWCC Ft. Walton Beach Office
Mary Esther Cutoff
Evening Office (K Bldg.)
Counseling Office (E Bldg.)
OWCC Chautauqua Neighborhood Center,
DeFuniak Springs
Dean of Instruction (A Bldg.)

Faculty advisors are assigned based upon the student's declared program objective. These advisors will assist students to prepare a program plan which may be used as a guide in the selection of courses each semester. Advisors are assigned from the departments as listed below. Students who have not selected a program objective are assigned among the various departments.



GRAPHICS AND PRINTING INSTRUCTOR, Bob Atwood, advises a student on the proper procedures for using the big camera.

SPECIAL COMMENTS CONCERNING ENGLISH AND READING

1. Students who score below acceptable minimums on Writing and Reading placement tests must take the appropriate college preparatory course — ENC 1000A and/or REA 1000A.
2. Students who score at or above the minimum cutoff levels **may** take the college prep course; however, it is recommended that students scoring above the cutoff in writing but who still need assistance with the basics plan to take LIN 1340 Writing/Grammar, a 3-credit course which reviews basic rules of grammar with emphasis on paragraph development. This course may be used as a general education elective for the AA Degree and to meet part of the English requirements for the AS and AS/AAS Option Degrees.

3. REA 2105 Advanced Reading is recommended for students scoring above the placement cutoff level but who need to increase their reading speed and level of comprehension.
4. Students score **below** the cutoff level in reading are advised to limit the number of courses they schedule each term that require extensive reading until completing REA 1000A College Prep Reading.
5. Students scoring below the cutoff level in one or more categories are required to enroll in at least one college prep course each semester until all deficiencies are removed. Only three attempts are allowed in each college prep course according to State Department of Education rules.

The following diagram indicates certain required and recommended tracks to satisfy requirements for English communications and reading:

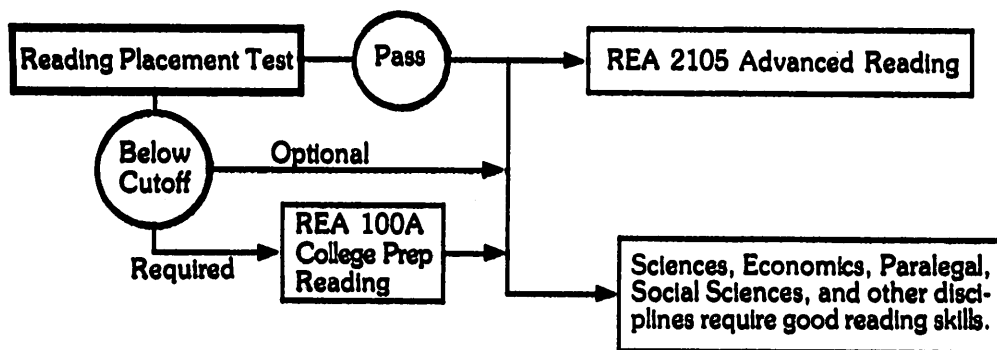
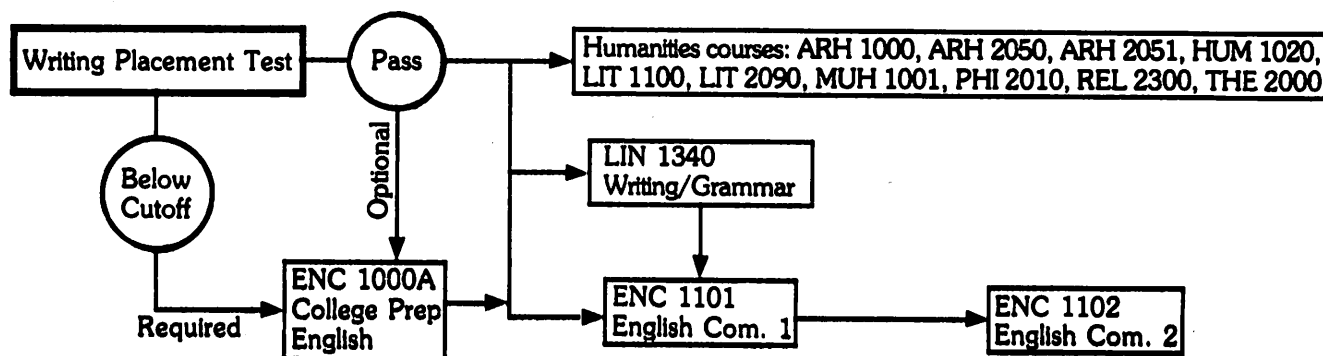

SPECIAL COMMENTS CONCERNING MATHEMATICS

The following diagram indicates possible tracks to satisfy mathematics requirements depending upon background and program needs:

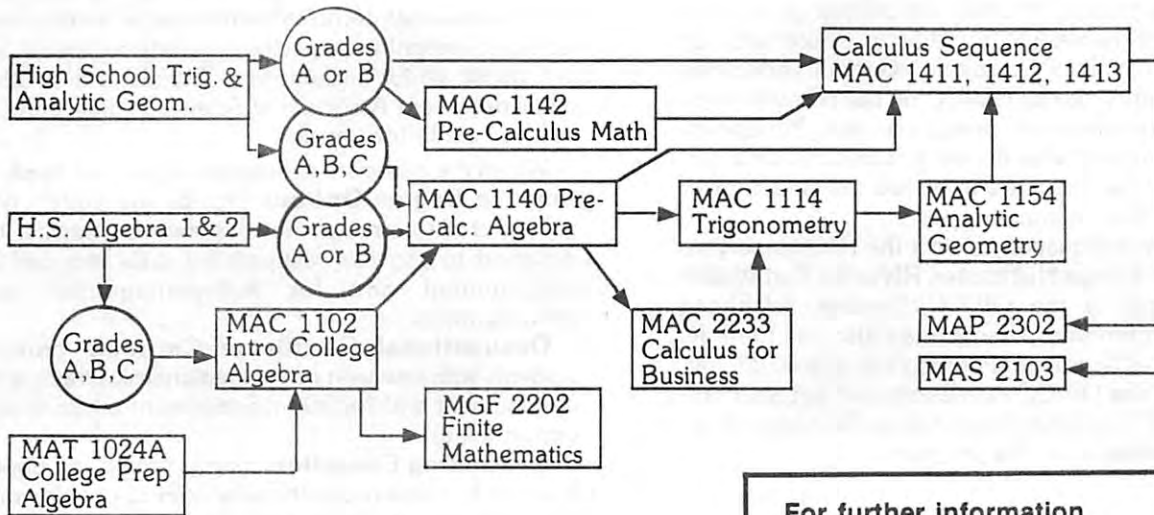

For further information
contact any OWCC math
teacher, program advisor,
or counselor.

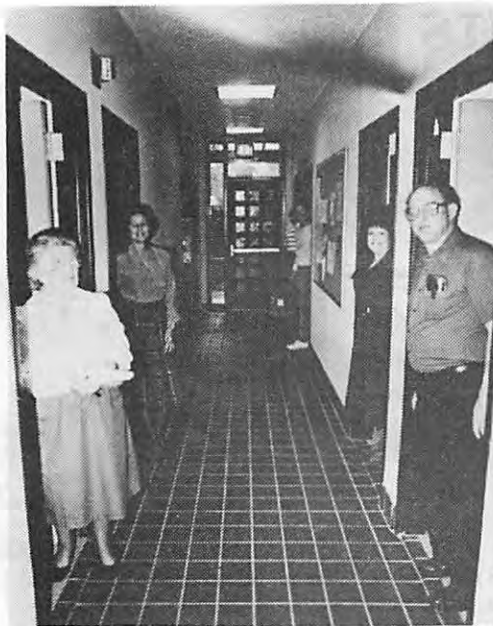

THE MATH department.



RECOGNIZING EMPLOYEES for their years of service for the first time, Jeff McInnis and Hilda Coursey, Board Members, assist President James R. Richburg in handing out certificates recognizing employees service to the college.

SPECIAL COMMENTS CONCERNING NURSING

In addition to the Pre-Nursing AA degree program described under the Biology Department, a **career mobility program in nursing** is offered for Licensed Practical Nurses to facilitate earning an Associate of Science degree in Nursing and becoming an RN (also coordinated by the Biology Department). This program is offered through an agreement between Okaloosa-Walton Community College and Pensacola Junior College, and all nursing courses are offered at the joint OWCC/UWF center in Fort Walton Beach with lab assignments in local hospitals. General education courses are provided by OWCC on the Niceville campus and at its various off-campus centers. Persons interested in nursing who do not possess the LPN certificate would be expected to attend selected courses on the PJC Warrington campus.

For further information contact the PJC nursing instructor, Mrs. Evelyn Huffmaster, RN at the Fort Walton Beach Center or the OWCC Director, telephone 244-1000. Interested persons may also call the PJC Department of Nursing in Pensacola at 476-0120, ext. 204 or 254. The OWCC Admissions and Registrar's office and the Fort Walton Beach Center have special application materials for this program.

PROGRAMS

Okaloosa-Walton Community College offers two basic degrees which students may pursue for the purpose of completing specific goals: the Associate of Arts

degree and the Associate of Science degree, including Applied Science Options. In Addition, the college offers occupational certificates and other educational and community services to provide total educational opportunities for the community.

The **Associate of Arts degree** provides full credit for transfer to other institutions for the purpose of satisfying the requirements for a baccalaureate degree.

The **Associate of Science degree** provides the student with college-credit curricula not specifically designed for transfer but designed to prepare persons for semi-professional, technical or managerial employment for advancement in a specific occupational area. Certain public senior institutions in Florida and in other states **do** accept Associate of Science degree students with full credit for transfer.

Within the Associate of Science degree, the **Applied Science Degree Options** provide the student with college-credit curricular not designed for transfer but designed to provide occupational skills required for employment and for mid-management and advancements.

Occupational Certificate Curricula provides students with one year of occupational skill training for employment and for mid-management advancement opportunities.

Continuing Education courses provide an opportunity to increase occupational efficiency or to become more effective in the use of leisure time. Continuing Education Units (CEU's)* are earned by completing these experiences. These CEU's allow individuals to accumulate, update, and transfer their records of continuing education evidence of progress made in fulfilling personal improvement goals.

ASSOCIATE OF ARTS DEGREE PROGRAM REQUIREMENTS

Associate of Arts curricula are offered for those students planning to transfer to a four-year institution for the last two years of a bachelor's degree program. SIXTY-FOUR (64) HOURS ARE REQUIRED FOR GRADUATION.

Courses in Residence. The minimum is normally 15 semester hours preceding graduation.

General Education. The general education program for the Associate of Arts degree at Okaloosa-Walton Community College embraces a minimum of 42 semester hours of academic credit in communications, humanities, social sciences, mathematics, sciences, and physical education, as follows:



DR. MARY STEGALL, Social Science Instructor, explains the effects drugs have on the mind.

*One Continuing Education Unit (C.E.U) is ten (10) contact hours of participation in an organized continuing education experience under responsible sponsorship, capable direction, and qualified instruction.

NOTE – NOTE – NOTE – NOTE – NOTE

Florida Administrative Code Rules mandate completion of the following actions by all Associate of Arts students prior to receipt of an Associate of Arts degree:

1. **TAKING OF THE COLLEGE LEVEL ACADEMIC SKILLS TEST (CLAST).** Students graduating with an Associate of Arts degree are required to take the CLAST according to the schedules as listed in the Calendar of Instructional Activities in this catalog. The minimum passing scores in effect from August 1, 1986, through July 31, 1989, for CLAST subtests are: (a) essay 4; (b) writing 270; (c) reading 270 and; (d) computation 275. After August 1, 1989, the state-adopted passing scores are scheduled to be as follows: reading 295; writing 295; computation 295; and essay 5.
2. **TWELVE (12) SEMESTER HOURS WITHIN SPECIFIED COURES** which require at least six thousand (6,000) words of written work per course. This requirement is met by passing with a "C" twelve (12) hours of English and humanities selected from the courses listed in bold face under General Requirements for the Associate of Arts degree.*
3. **SIX (6) SEMESTER HOURS OF MATHEMATICS** courses of college algebra or higher. This requirement is met by passing with a "C" six (6) hours of mathematics listed under General Requirements for the Associate of Arts degree.**
4. **SLS 1101 (COMPASS)** is a required course for all entering, full-time (12 credits), AA students. Part-time AA students must take this course in the semester they are enrolled in their 12th credit.

GENERAL EDUCATION REQUIREMENTS ASSOCIATE OF ARTS DEGREE* (42 Semester Hour Minimum)

Sem.	Hrs.	Course Selections
Biological Science	4-8	APB 1150 or BOT 1010C or ZOO 1010C or PCB 2011 or APB 1150C and APB 1151C
Communications Skills		↓ ENC 1101/1102
Humanities	6*	↓ HUM 1020 or ARH 1000 or MUH 1011; ARH 2050-ARH 2051 or PHI 2010 or REL 2300 or LIT 1100 or LIT 2090, THE 2000
Mathematics	6**	MAC 1102, MAC 1140, MAC 1114, MAC 1154, MAC 1411, MAC 1412, MAC 1413, MAC 2233, MAP 2302, MAS 2103, MGF 2202
Physical Education	4	↓ Any designated activity course. No more than 4 semester hours in activity courses may be included in the 64 hours of the degree. HLP 1081 may be used toward satisfying the activity requirement.
Electives	6	✓ SPC 1600, CGS 1060, foreign language, or others as listed on the following page.
Physical Science	4-8	↓ CHM 1020 or GLY 1001 or MET 1010/OCE 1005 or PHY 1020 or CHM 1045/1046 or PHY 2048/2049 or PHY 1053/1054
Social Science	6	↓ AMH 2010/2020 or WOH 1012/1022 or POS 1041 or AMH 1041 or POT 1002, or WOH 2040 or INR 2002 or PSY 2012 and SYG 2000, SYG 2010

*Communications and humanities courses listed on this page meet the 6000 word writing assignment as required by FAC Rule 6A-10.030, and credits earned in the fall semester of 1982 or later in these courses at OWCC or by transfer shall be based on a minimum grade of "C".

**Mathematics courses listed on this page meet the mathematics requirements for FAC Rule 6A-10.030, and credits earned in the fall semester of 1982 or later at OWCC or by transfer shall be based on a minimum grade of "C".

General Electives. Students who complete the minimum General Education sequence with less than 42 semester hours will have to complete sufficient additional hours from the general education courses previously listed or from the following list of general education electives to reach the 42 semester hours required. In some specializations, specific general education courses are designated and shall be chosen as specifically indicated (exclusive of College Preparatory courses).

- CGS 1060 Computer Literacy
- ECO 2013 Economics I
- ECO 2023 Economics II
- LIN 1340 Writing/Grammar
- LIT 2100 Approach to Literature
- LIT 2164 Contemporary Literature
- SPC 1600 Speech
- CHM 2210C Organic Chemistry I

FOREIGN LANGUAGE — Any college-credit foreign language course.*

MATH — Any degree-credit Math Department courses except:

- MAT 2905 Tutorial
- MAT 2949 Directed Work Study
- MGF 2118 Quantitative Skills Seminar

BIOLOGY — Any college-credit Biology Department course except:

- BSC 2946 Directed Work Study
- BSC 2905 Tutorial

*The RAISE BILL enacted by the Florida Legislature states that beginning fall, 1987, FOREIGN LANGUAGE CREDITS will be required prior to being admitted to a STATE UNIVERSITY (two years of foreign language in high school or two semesters of foreign language at a community college).

Area of Emphasis: In addition to the required 42 semester hours of General Education, each student must complete an additional 22 hours in a specialization as listed in this section. Other areas of emphasis may be developed under the guidance of a faculty advisor or counselor and approved by the Dean of Instruction. NOTE: some areas of emphasis specify more than 22 semester hours — **students should consult their designated faculty advisor to select the appropriate courses in the specialized field that will fulfill the 64-hour requirement for graduation.**

CUSTOM-DESIGNED ASSOCIATE OF ARTS DEGREE PROGRAM

Specialized, custom-designed programs may be developed to permit individualized planning of curricula to satisfy the first two-year requirements of specialized four-year degree programs.

Students seeking a specialized, custom-designed program may request approval by the Dean of Instruction or the Dean of Vocational-Technical Education and Department Chair of any of the following disciplines of a specially designed sequence which, with the General Education sequence, will meet degree requirements: Biological Science; Business; Home Economics and Consumer Education; Communications; Fine and Performing Arts; Mathematics; Physical Science; Physical Education; Social Science; Criminal Justice; and Paralegal.



THE COLLEGE President, Dr. James R. Richburg, addresses the articulation team from Florida State University which visited the campus to answer questions about their programs, procedures, and general methods of operation.

BUSINESS*

Area of Emphasis: BANKING**

General Education courses selected from those listed for AA degree on page 43.

Specific General Education Courses	Sem. Hrs.
ECO 2013 Economics I	3 ✓
ECO 2023 Economics II	3 ✓
MAC 1140 Pre-Calculus Algebra	3 ✓
MAC 2233 Calculus for Business	3 ✓

Specialization Courses

BAN 1004 Principles of Bank Operations	3
ACG 2001 Accounting I	3
ACG 2011 Accounting II	3
BUL 2111 Business Law I	3 ✓
BUL 2112 Business Law II	3
BAN 2501 Money and Banking	3
BAN 2900 Directed Study in Banking	1
CGS 1060 Computer Literacy	3 ✓
GEB 1011 Introduction to Business	3 ✓

*Many upper-level university programs recommend that students complete lower division courses in oral communications, college algebra, statistics, accounting, and economics prior to transfer. Students are urged to check with the institution to which they plan to transfer. Guidance may be received from the business faculty advisor.

**Students must see a business advisor to select the basic and elective courses for the degree total of 64 semester hours.

Area of Emphasis: BUSINESS TEACHER EDUCATION*

General Education courses selected from those listed for AA degree on page 43.

Specific General Education Courses	Sem. Hrs.
ECO 2013 Economics I	3
ECO 2023 Economics II	3
MAC 2233 Calculus for Business	3
MAC 1140 Pre-Calculus Algebra	3

Electives*

OST 1110 Intermediate Typewriting	2
OST 2120 Advanced Typewriting	2
OST 1212 Intermediate Shorthand	3
STA 1014 Statistics	3
ACG 2001 Accounting I	3
ACG 2011 Accounting II	3
BUL 2111 Business Law I	3
OST 2213 Advanced Shorthand	3
OST 2721 Word Processing Software I	3
OST 2722 Word Processing Software II	3
OST 2335 Business Communications	3
MTB 1103 Business Math	3
EDF 1005 Introduction to Education	3
GEB 1011 Introduction to Business	3
OST 1141 Keyboarding	1
CGS 1060 Computer Literacy	3

*Students must see a business advisor to select the basic and elective courses for the degree total of 64 semester hours.

Area of Emphasis: BUSINESS ADMINISTRATION*

General Education courses selected from those listed for AA degree on page 43.

Specific General Education Courses	Sem. Hrs.
ECO 2013 Economics I	3 ✓
ECO 2023 Economics II	3 ✓
SPC 1600 Speech	3 ✓
MAC 1140 Pre-Calculus Algebra	3 ✓
MAC 2233 Calculus for Business	3 ✓

Specialization Courses

CGS 1060 Computer Literacy	3 ✓
ACG 2001 Accounting I	3 ✓
ACG 2011 Accounting II	3 ✓
STA 1014 Statistics	3 ✓

*Electives

BUL 2111 Business Law I	3 ✓
BUL 2112 Business Law II	3 ✓
MAN 2021 Management	3 ✓
MNA 2100 Human Relations	3 ✓
MAR 2151 Retail Management	3 ✓
OST 2335 Business Communication	3 ✓
GEB 1011 Introduction to Business	3 ✓
MKA 2021 Salesmanship	3 ✓
MKA 2511 Introduction to Advertising	3 ✓
MAR 2011 Introduction to Marketing	3 ✓
CIS 1000 Data Processing Concepts	3 ✓

*Students must see a business advisor to select the basic and elective courses for the degree total of 64 semester hours.



TAXES are always changing. What worked last year may not be around this year Donna K. Utey, Business Instructor, tells her class.

Area of Emphasis:

**COMPUTER SCIENCE
COMPUTER INFO SYSTEMS
OPTION***

General Education courses selected from those listed for AA degree on page 43.

Specific General Education Courses		Sem. Hrs.
ECO 2013	Economics I	3
ECO 2023	Economics II	3
MAC 1140	Pre-Calculus Algebra	3
MAC 2233	Calculus for Business	3

Specialization Courses

STA 1014	Statistics	3
ACG 2001	Accounting I	3
ACG 2021	Accounting II	3
CIS 1000	Data Processing Concepts	3
COP 2120	COBOL Programming	4
COP 2200	FORTRAN Programming	4
COP 2000	Programming I	3
COP 2001	Programming II	3
OST 1141	Keyboarding	1
CGS 2560	Intro. to Microcomputers/MS-DOS	1

*Students must see an advisor to select the basic and elective courses for the degree total of 64 semester hours.

Area of Emphasis:

HOSPITALITY MANAGEMENT*

General Education courses selected from those listed for AA degree on page 43.

Specific General Education Courses		Sem. Hrs.
CGS 1060	Computer Literacy	3
ECO 2011	Economics I	3

Specialization Courses

ACG 2001	Accounting I	3
ACG 2011	Accounting II	3
OST 2335	Business Communications	3
MAR 2021	Intro. to Marketing	3
MKA 2511	Intro. to Advertising	3
HFT 2010	Hospitality Management	3
BUL 2111	Business Law I	3

*Students must see an advisor to select the basic and elective courses for the degree total of 64 semester hours.

Area of Emphasis:

MARKETING*

General Education courses selected from those listed for AA degree on page 43.

Specific General Education Courses		Sem. Hrs.
ECO 2013	Economics I	3
ECO 2023	Economics II	3
PSY 2012	Psychology	3
MAC 2233	Calculus for Business	3
MAC 1140	Pre-Calculus Algebra	3

Specialization Courses

ACG 2001	Accounting I	3
ACG 2011	Accounting II	3
MAR 2011	Introduction to Marketing	3
MKA 2021	Salesmanship	3
MKA 2511	Introduction to Advertising	3
MKA 2930	Marketing Seminar I	2
MKA 2931	Marketing Seminar II	2
MKA 2932	Marketing Seminar III	2
STA 1014	Statistics	3

*Students must see an advisor to select the basic and elective courses for the degree total of 64 semester hours.

Area of Emphasis:

REAL ESTATE*

General Education courses selected from those listed for AA degree on page 43.

Specific General Education Courses		Sem. Hrs.
ECO 2013	Economics I	3
MAC 1140	Pre-Calculus Algebra	3
MAC 2233	Calculus for Business	3

Specialization Courses

GEB 1011	Introduction to Business	3
REE 1040	Introduction to Real Estate	3
ACG 2001	Accounting I	3
ACG 2011	Accounting II	3
BUL 2111	Business Law I	3
BUL 2112	Business Law II	3
STA 1014	Statistics	3
CGS 1060	Computer Literacy	3

*Business electives should be chosen from the following after consultation with the faculty advisor: OST 2335 Business Communications; MKA 2021 Salesmanship; REE 1200 Real Estate Finance; REE 2300 Real Estate Investments.



ANDY BEASLEY, Business Education Instructor, conducts a class in economics.

Area of Emphasis:

**COMPUTER SCIENCE
SYSTEMS AND CONTROL
ENGINEERING OPTION***

General Education courses selected from those listed for AA degree on page 43.

Specific General Education Courses		Sem. Hrs.
MAC 1411	Calculus I	4
MAC 1412	Calculus II	4
MAC 1413	Calculus III	4
PHY 2048C	College Physics I	4
PHY 2049C	College Physics II	4

Specialization Courses

CIS 1000	Data Processing Concepts	3
COP 2000	Programming I	3
COP 2110	FORTTRAN Programming	3
MAP 2302	Differential Equations	3
MAS 2103	Linear Algebra	3
CGS 2560	Intro. to Microcomputers/MS-DOS	1

*Students must see an advisor (preferably a data processing/business advisor) to select the basic and elective courses for the degree total of 64 semester hours.

**COMMUNICATIONS,
HUMANITIES,
AND THE ARTS**

Area of Emphasis:

FOREIGN LANGUAGE*

General Education courses selected from those listed for AA degree on page 43.

Specialization Courses (Select courses in one language to fulfill the 64 semester hours graduation requirements. Special programs in multiple languages may be developed in cooperation with a foreign language advisor.)

Specific General Education Courses		Sem. Hrs.
French		
FRE 1100	French I	4
FRE 1101	French II	4
FRE 2200	French III	4
FRE 2201	French IV	4
FRE 2100	Introduction to French Literature I	3
FRE 2101	Introduction to French Literature II	3

German

GER 1100	German I	4
GER 1101	German II	4
GER 2200	German III	4
GER 2201	German IV	4
GER 2420	Advanced German Grammar and Composition I	3
GER 2421	Advanced German Grammar and Composition II	3
GER 2500	German Civilization and Culture	3
GEW 2010	Introduction to German Literature I	3
GEW 2011	Introduction to German Literature II	3

Spanish

SPN 1100	Spanish I	4
SPN 1101	Spanish II	4
SPN 2200	Spanish III	4
SPN 2201	Spanish IV	4
SPN 2300	Advanced Spanish Grammar and Composition I	3
SPN 2301	Advanced Spanish Grammar and Composition II	3
SPW 2100	Introduction to Spanish Literature I	3
SPW 2101	Introduction to Spanish Literature II	3

*Students must see an advisor to select the basic and elective courses for the degree total of 64 semester hours.

Area of Emphasis:

**TEACHER EDUCATION-
ELEMENTARY***

General Education courses selected from those listed for AA degree on page 43.

Specific General Education Courses		Sem. Hrs.
CHD 1220	Child Growth and Development I	
	or	
DEP 2004	Human Growth and Development	3
COC 1020	Computer Literacy	3
EDF 1005	Introduction to Education	3
LIT 2100	Approach to Literature	3
	or	
LIT 2090	Contemporary Literature	3
MUT 1001	Fundamentals of Music	3
PSY 2012	Psychology	3
SPC 1600	Speech	3
MAE 2810	Math for Elementary Teachers	3

Recommended Electives

CHD 1230	Child Growth and Development II	3
CHD 1430	Observing and Recording Child Behavior	3
GLY 1001	Earth Science	4

**Foreign Languages
Typewriting****

*Each student must consult an academic advisor to select the appropriate basic and elective courses.

**Unless a student is already a competent typist, the development of typewriting skills is strongly recommended.



A PERENNIAL SUCCESS, Arsenic and Old Lace was performed by the Proscenium Playhouse.

Area of Emphasis:

TEACHER EDUCATION-SECONDARY*

General Education courses selected from those listed for AA degree on page 43.

Specific General Education Courses		Sem. Hrs.
CGS 1060	Computer Literacy	3
EEP 1015	Introduction to Education	3
EPP 2100**	Education Psychology	3
LIT 2100	Approach to Literature	3
or		
LIT 2090	Contemporary Literature	3
PSY 2012	Psychology	3
SPC 1600	Speech	3

Recommended Electives

- Foreign Languages
- Typewriting***

*Students must see an advisor to select the basic and elective courses for the degree total of 64 semester hours.
 **Selected four-year institutions require this course to be taken after transfer.
 ***Unless a student is already a competent typist, the development of typewriting skills is strongly recommended.

Area of Emphasis:

ART*

General Education courses selected from those listed for AA degree on page 43.

Specific General Education Courses		Sem. Hrs.
ARH 2050	Art History Survey I	3
ARH 2051	Art History Survey II	3

Specialization Courses

ART 1300C	Drawing I	3
ART 1301C	Drawing II	3
ART 1201C	Design I (2 Dimensional)	3
ART 1202C	Design II (3 Dimensional)	3

Art Electives (Any four of the following courses):

ART 1110C	Pottery I	3
ART 1111C	Pottery II	3
ART 1701C	Sculpture I	3
ART 1702C	Sculpture II	3
ART 2510C	Painting I	3
ART 2520C	Painting II	3

*Students must see an advisor to select the basic and elective courses for the degree total of 64 semester hours.

Area of Emphasis:

HUMANITIES*

General Education courses selected from those listed for AA degree on page 43.

Specific General Education Courses		Sem. Hrs.
HUM 1020	Humanities — Introduction	3
PHI 2010	Humanities — Philosophy	3
REL 2300	Humanities — Comparative Religion	3
ARH 2050	Art History Survey I	3
ARH 2051	Art History Survey II	3
ARH 1000	Humanities Art	3
MUH 1011	Humanities Music	3
THE 2000	Theatre	3
LIT 2100	Approach to Literature (World)	3

Other Specialization Courses

Electives as needed in specific arts and humanities courses from area(s) of weakness and special interest:

Art Labs

- ART 1300C, ART 1301C, ART 1110C, ART 1111C, ART 1201C, ART 1202C, ART 1400C, ART 1701C, ART 1115C, ART 2510C, ART 2520C.

*Students must see an advisor to select the basic and elective courses for the degree total of 64 semester hours.

Area of Emphasis:

MINISTRY*

General Education courses selected from those listed for AA degree on page 43.

Specific General Education Courses		Sem. Hrs.
PHI 2010	Humanities — Philosophy	3
REL 2300	Humanities — Comparative Religion	3
SPC 1600	Speech	3
LIT 2100	Approach to Literature	3
PSY 2012	Psychology	3
SYG 2000	Sociology	3

*Students must see an advisor to select the basic and elective courses for the degree total of 64 semester hours.
 NOTE: Ministry electives should be selected according to goals of the student's individual program. Electives may vary due to area (e.g., evangelical, pastorate, music ministry, religious graduation, etc.) and denominational emphasis or needs.

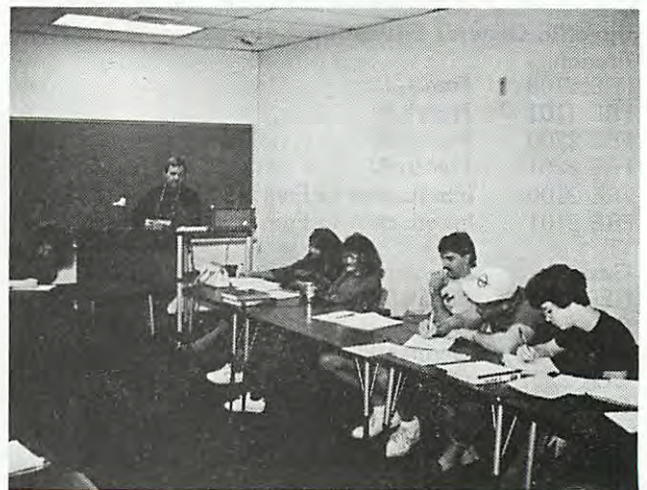

A HUMANITIES CLASS listens as Walter Shipley, Instructor, explains the development of music and contributions to music made by different cultures.

HUMAN DEVELOPMENT AND CONTINUING EDUCATION

Area of Emphasis: TEACHER EDUCATION- EARLY CHILDHOOD

General Education courses selected from those listed for AA degree on page 43.

Specific General Education Courses		Sem. Hrs.
PSY 2012	Psychology	3
SOC 2000	Sociology	3
CGS 1060	Computer Literacy	3

Specialization Courses:		
CHD 1220	Child Growth and Development I	3
CHD 1230	Child Growth and Development II	3
CHD 1430	Observing and Recording Child Behavior	3
CHD 2322	Programming for Young Children	3
CHD 2432	Curriculum for Young Children	3
HOE 1010	Introduction to Home Economics	3
HUN 2410	Child Nutrition and Health	3
	or	
HUN 2001	Nutrition	3

Area of Emphasis: FASHION MERCHANDISING *

General Education courses selected from those listed for AA degree on page 43.

Specific General Education Courses		Sem. Hrs.
PSY 2012	Psychology	3
ECO 2013	Economics I	3

Fashion Merchandising – Specialization Courses		
ACG 2001	Accounting I	3
CTE 1310	Clothing Construction I	3
CTE 1401	Textiles	3
COA 2100	Consumer Education	3
MAR 2011	Introduction to Marketing	3
MAR 2151	Retail Management	3
MKA 2511	Advertising	3
MKA 2021	Salesmanship	3

*Students must see Home Economics/Consumer Education faculty advisor to select basic general and elective courses for the degree total of 64 semester hours.

Area of Emphasis: HOME ECONOMICS EDUCATION *

General Education courses selected from those listed for AA degree on page 43.

Specific General Education Courses		Sem. Hrs.
ECO 2013	Economics I	3
PSY 2012	Psychology	3
CHM 1045C	College Chemistry I	4

Specialization Courses		
HOE 1010	Introduction to Home Economics	3
COA 2100	Consumer Education	3
HUN 2001	Nutrition	3
CTE 1310	Clothing Construction I	3
CHD 1220	Child Growth and Development I	3
HHD 2110	Home Planning and Furnishings	3
FSS 1210C	Family Meal Planning	3

*Students must see Home Economics/Consumer Education faculty advisor to select basic general and elective courses for the degree total of 64 semester hours.

Area of Emphasis: HOUSING AND INTERIOR DESIGN *

General Education courses selected from those listed for AA degree on page 43.

Specific General Education Courses		Sem. Hrs.
PSY 2012	Psychology	3
SOC 2000	Sociology	3
ECO 2013	Economics I	3

Specialization Courses:		
HOE 1010	Introduction to Home Economics	3
COA 2100	Consumer Education	3
HHD 2110	Home Planning and Furnishings	3
CTE 1401	Textiles	3
ART 1201C	Design I	3
ART 1300	Drawing	3
ARC 2121C	Architectural Drafting	3

*Students must see Home Economics/Consumer Education faculty advisor to select basic general and elective courses for the degree total of 64 semester hours.

Area of Emphasis: NUTRITION AND DIETETICS *

General Education courses selected from those listed for AA degree on page 43.

Specific General Education Courses		Sem. Hrs.
PSY 2012	Psychology	3
CHM 1045C	College Chemistry I	4
PCB 2011	Cell Biology	4
CGS 1060	Computer Literacy	3

Specialization Courses		
HUN 2001	Nutrition	3
APB 1200C	Human Anatomy and Physiology	4
COA 2100	Consumer Education	3
MAN 2000	Management	3
HOE 1010	Introduction to Home Economics	3

*Students must see Home Economics/Consumer Education faculty advisor to select basic general education and elective courses for the degree total of 64 semester hours.

MATHEMATICS AND SCIENCES

ASSOCIATE OF ARTS DEGREE

Area of Emphasis: ENGINEERING*

General Education courses selected from those listed for AA degree on page 43.

Specific General Education Courses	Sem. Hrs.
MAC 1411** Calculus I	4
CHM 1045C College Chemistry I	4
CHM 1046C College Chemistry II	4
PHY 2048C College Physics I	4
PHY 2049C College Physics II	4

Specialization Courses

MAP 2302 Differential Equations	3
MAC 1412 Calculus II	4
MAC 1413 Calculus III	4
MAS 2103 Linear Algebra	3
EGN 1120C Engineering Graphics	3
ENG 1130C Descriptive Geometry	3

*Students must see an advisor (preferably in the Mathematics Department) to select the basic and elective courses for the degree total of 64 semester hours.

**Other mathematics courses may be needed to prepare for MAC 1411.
NOTE: The courses CIS 1000, COP 2000, and COP 2200 should be taken if time permits. Students will need to identify the college or university to which they plan to transfer plus the branch of engineering to permit proper course selection.

Area of Emphasis: MATHEMATICS (METEOROLOGY)*

General Education courses selected from those listed for AA degree on page 43.

Specific General Education Courses	Sem. Hrs.
MAC 1411** Calculus I	4
CHM 1045C College Chemistry I	4
CHM 1046C College Chemistry II	4
PHY 2048C College Physics I	4
PHY 2049C College Physics II	4

Specialization Courses

MAP 2302 Differential Equations	3
MAC 1412 Calculus II	4
MAC 1413 Calculus III	4
MAS 2103 Linear Algebra	3
MET 1010 Introduction to Meteorology	3

*Foreign language recommended for meteorology students. Students must see an advisor to select the basic and elective courses for the degree total of 64 semester hours.

**Other Mathematics courses may be needed to prepare for MAC 1411.
NOTE: The courses CRM 1020, COP 2000, and COP 2110 should be taken if time permits.

Area of Emphasis: BIOLOGY (MARINE, FORESTRY, TEACHER ED.)*

General Education courses selected from those listed for AS degree on page 43.

Specific General Education Courses	Sem. Hrs.
CHM 1045C College Chemistry I	4
CHM 1046C College Chemistry II	4
BOT 1010C Botany	4
ZOO 1010C Zoology	4
MAC 1411 Calculus I	4

Specialization Courses

Foreign Language Recommended	
CHM 2210C Organic Chemistry I	4
CHM 2211C Organic Chemistry II	4
PCB 2011 Cell Biology	4

Select one course from the following:

MCB 2013C Microbiology	4
ECO 2013 Economics I (Forestry only)	3

*Students must see an advisor to select the basic and elective courses for the degree total of 64 semester hours.

Area of Emphasis: PRE-NURSING* & PHYSICAL THERAPY

General Education courses selected from those listed for AA degree on page 43.

Specific General Education Courses	Sem. Hrs.
SPC1600 Speech	3
SYG 2000 Sociology	3
CHM 1045C College Chemistry I	4
CHM 1046C College Chemistry II	4
PCB 2011 Cell Biology	4
ZOO 1010C Zoology	4

Specialization Courses

APB 1200C Anatomy and Physiology I	3
APB 1201C Anatomy and Physiology II	3
HUN 2001 Nutrition	3
DEP 2004 Human Growth and Development	3
PSY 2012 Psychology	3
APB 1231C Microbiology Allied Health	4

*The proper selection of courses in this program is very important. Any student planning to major in nursing at a junior or senior institution should get a catalog from the institution so that the necessary OWCC courses may be completed, in cooperation with a faculty advisor.

Area of Emphasis:

**PRE-PROFESSIONAL
(MEDICINE, VETERINARY,
DENTISTRY)**

General Education courses selected from those listed for AA degree on page 43.

Specific General Education Courses	Sem. Hrs.
CHM 1045C College Chemistry I	4
CHM 1046C College Chemistry II	4
PCB 2011 Cell Biology	4
ZOO 1010C Zoology	4

Specialization Courses

Foreign Language	6
CHM 2210C Organic Chemistry I	4
CHM 2211C Organic Chemistry II	4
BOT 1010C Botany	4
MAC 1411 Calculus	4
MCB 2013C Microbiology	4
PHY 2048C College Physics I	4
PHY 2048C College Physics I	4
PHY 2049* College Physics II	4
PHY 1053C* Physics I	4
PHY 1054C* Physics II	4

* Depending upon university/medical school requirements.

Area of Emphasis:

MEDICAL TECHNOLOGY*

General Education courses selected from those listed for AA degree on page 43.

Specific General Education Courses	Sem. Hrs.
CHM 1045C College Chemistry I	4
CHM 1046C College Chemistry II	4
PCB 2023 Cell Biology	4
ZOO 1010C Zoology	4

Specialization Course

Foreign Language	6
APB 1200C Anatomy and Physiology I	3
APB 1201C Anatomy and Physiology II	3
MCB 2013C Microbiology	4
BOT 1010C Botany	4
CHM 2210C Organic Chemistry I	4
CHM 2211C Organic Chemistry II	4

*The proper selection of courses in this program is very important. Any student planning to major in this program at a senior institution should get a catalog from the institution to develop an appropriate program at OWCC.

Area of Emphasis:

PRE-PHARMACY*

General Education courses selected from those listed for AA degree on page 43.

Specific General Education Courses	Sem. Hrs.
MAC 1114 Trigonometry	3
CHM 1045C College Chemistry I	4
CHM 1046C College Chemistry II	4
BOT 1010C Botany	4
ZOO 1010C Zoology	4

Specialization Courses

Foreign Language	6
MAC 1411 Calculus I	4
CHM 2210C Organic Chemistry I	4
CHM 2211C Organic Chemistry II	4
PCB 2011 Cell Biology	4
MCB 2013C Microbiology or	4
ECO 2013 Economics I	3
ECO 2023 Economics II	3

* Students must see an advisor to select the basic and elective courses for the degree total of 64 semester hours.

Area of Emphasis:

CHEMISTRY*

General Education courses selected from those listed for AA degree on page 43.

Specific General Education Courses	Sem. Hrs.
CHM 1045C College Chemistry I	4
CHM 1046C College Chemistry II	4
BOT 1010C Botany	4
ZOO 2020C Zoology	4
MAC 1411** Calculus I	4

Specialization Courses

MAC 1412 Calculus II	4
MAC 1413 Calculus III	4
CHM 2210C Organic Chemistry I	4
CHM 2211C Organic Chemistry II	4
PHY 2048C College Physics I	4
PHY 2049C College Physics II	4
MAP 2302 Differential Equations	3

* Students must see an advisor to select the basic and elective courses for the degree total of 64 semester hours.

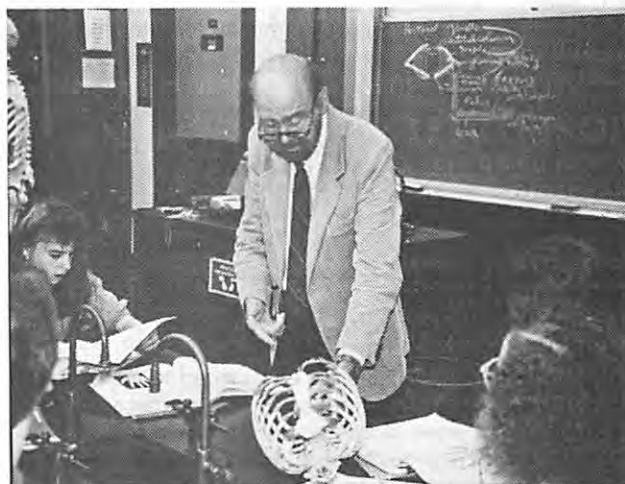

ANATOMY AND PHYSIOLOGY, a must for the pre-med student, are taught at OWCC. Dr. Roy Bundy, instructor, helps by explaining to students characteristics of the rib cage.

Area of Emphasis:

PHYSICS *

General Education courses selected from those listed for AA degree on page 43.

Specific General Education Courses **Sem. Hrs.**
(Consult catalog for accepted combinations for Humanities and Social Sciences.)

MAC 1411**	Calculus I	4
CHM 1045C	College Chemistry	4

Specialization Courses

MAC 1412	Calculus II	4
MAC 1413	Calculus III	4
MAS 2103	Linear Algebra	3
MAP 2302	Differential Equations	3
CHM 1046C	College Chemistry II	4
PHY 2048C	College Physics I	4
PHY 2049C	College Physics II	4

* See departmental advisor for options and substitutions. Students must see an advisor to select the basic and elective courses for the degree total of 64 semester hours.

** Other mathematics courses may be needed to prepare for MAC 1411. NOTE: Introduction to Computer Programming, COC 1110, and other computer courses are recommended if time permits.

PHYSICAL EDUCATION

Area of Emphasis:

HEALTH, PHYSICAL EDUCATION AND RECREATION *

General Education courses selected from those listed for AA degree on page 43.

Specific General Education Courses **Sem. Hrs.**

EPP 1015	Introduction to Education	3
SPC 1600	Speech	3
PSY 2012	Psychology	3
APB 1150C	Biology	3
APB 1151C	Biology II	3

Specialization Courses

HSC 1400	First Aid	3
HSC 1000	Personal and Community Health	3
PET 1000	Introduction to Physical Education	3
LEI 2330	Camp Counseling	3
DEP 2004	Human Growth and Development	3
EPP 2100	Educational Psychology	3
APB 1200C	Anatomy and Physiology I	3
APB 1201C	Anatomy and Physiology II	3
LEI 1000	Introduction to Recreation	3
EMS 1065C	Cardiopulmonary Resuscitation	1
PEM 1110	Fitness Concepts	1
HUN 2001	Nutrition	3
HLP 1081	Wellness: Practice and Theory	3

Physical Education majors are encouraged to enroll in as many activity, physical education courses as their academic schedules will permit. Only 4 semester hours in activity P.E. courses may be included in the 40 hours of required General Education Courses and toward graduation.

* Students must see a Health and P.E. advisor to select the basic and elective courses for the degree total of 64 semester hours.



GETTING the right grip leads to the right swing Gaius Bruce, Physical Education Instructor, tells golfing hopefuls.

PUBLIC SAFETY

Area of Emphasis:

CRIMINAL JUSTICE *

General Education courses selected from those listed for AA degree on page 43.

Required Core Courses: 12 Hours		Sem. Hrs.
CCJ 1000	Introduction to Criminology	3
CCJ 1020	Introduction to Criminal Justice	3
CCJ 1210	Criminal Law	3
CCJ 1230	Criminal Procedures	3

Law Enforcement Track – Electives

CCJ 1400	Police Organization and Administration	3
CJT 2100	Criminal Investigation	3
CJT 2140	Introduction to Criminalistics	3
CJT 2220	Forensics Photography	3
CJT 2340	Police Operations	3

Corrections Track – Electives

CJD 1420	Correctional Law	3
CJD 1460	Correctional Operations	3
CJD 2300	Introduction to Corrections	3

Criminal Justice General Track – Electives

CCJ 1500	Juvenile Delinquency	3
CCJ 1935	Criminal Justice Seminar	3
CCJ 1941	Internship – Criminal Justice	3
CCJ 2070	Intro. to Computer Appl. in Criminal Justice	3
CCJ 2905	Independent Study – Criminal Justice	1
LEA 1936	Legal Research	3
LEA 2937	Rules of Evidence	3

* NOTE: Students must see a Criminal Justice advisor to select the proper elective courses and to develop a plan for completing the degree total of 64 semester hours. Students interested in Pre-law should also see a Criminal Justice advisor.

**Area of Emphasis:
PARALEGAL ***

General Education courses selected from those listed for AA degree on page 43.

Required Core Courses: 12 hours		Sem. Hrs.
LEA 1935	Introduction to Paralegalism	3
LEA 1936	Legal Research	3
LEA 2937	Rules of Evidence	3
BUL 2111	Business Law I	3

Specialization Courses		
CCJ 1210	Criminal Law	3
CCJ 1270	Criminal Procedures	3
BUL 2112	Business Law II	3
ACG 2001	Accounting I	3

Electives		
CCJ 1935	Criminal Justice Seminar	3
LEA 1101	Introduction to Civil Law	3
LEA 2151	TORTS: Personal Injury Litigation	3
REE 2430	Real Estate Law	3

*Students must see a Criminal Justice advisor to select the proper elective courses and to develop a plan for completing the degree total of 64 semester hours.



THE EGLIN AFB CENTER serves as a focal point for making access to college easier for on base personnel. Here Reate Davis, Eglin Center Director, and Peggy Pajlouskas, Secretary, help an Eglin airman with an education question.

SOCIAL SCIENCE

**Area of Emphasis:
SOCIAL SERVICES ***

General Education courses selected from those listed for AA degree on page 43.

Select two of the following courses:		Sem. Hrs.
PHI 2010	Humanities — Philosophy	3
REL 2300	Humanities — Comparative Religion	3
LIT 2100	Approach to Literature	3

Specialization Courses		
	Foreign Language	12
CLP 1002	Personal Adjustment	3
CCJ 1000	Intro. to Criminology	3
CCJ 1020	Introduction to Criminal Justice	3
SYG 2430	Family and Society	3
POT 1002	Introduction to Political Science	3
CCJ 2300	Intro. to Corrections	3
PSY 2012	Psychology	3
CCJ 1210	Criminal Law	3
SYG 2000	Sociology	3
CCJ 1270	Criminal Procedures	3
CCJ 1500	Juvenile Delinquency	3

*Students must see a Social Science advisor to select the basic and elective courses for the degree total of 64 semester hours.

**Area of Emphasis:
SOCIAL SCIENCES ***

General Education courses selected from those listed for AA degree on page 43.

Specific General Education Courses		Sem. Hrs.
APB 1150	General Biology	4

Select two of the following courses:		Sem. Hrs.
PHI 2010	Humanities — Philosophy	3
REL 2300	Humanities — Comparative Religion	3
LIT 1201	Approach to Literature	3

Specialization Courses		
CLP 1002	Personal Adjustment	3
CCJ 1000	Intro. to Criminology	3
SYG 2430	Family and Society	3
DEP 2004	Human Growth and Development	3
CCJ 2300	Intro. to Corrections	3
INR 2002	Current World Problems	3
POT 1002	Introduction to Political Science	3
PSY 2012	Psychology	3
SYG 2000	Sociology	3

*Students must see a Social Science advisor to select the basic and elective courses for the degree total of 64 semester hours.

ASSOCIATE OF SCIENCE DEGREE PROGRAM REQUIREMENTS

Associate of Science Degree programs provide specialization in technical, business, semi-professional, and supervisory education. Okaloosa-Walton Community College has developed programs for such studies. Programs include study and practical applications. SIXTY-FOUR (64) HOURS ARE REQUIRED FOR GRADUATION.

Courses in Residence. Minimum requirement of courses taken in residence for an Associate of Science Degree is normally 15 semester hours of credit immediately preceding graduation.

General Education. The general program for the Associate of Science Degree embraces a minimum of 26 semester hours of academic credit in the areas of communications, humanities, social science, mathematics, science, and physical education, as follows:

NOTE – NOTE – NOTE – NOTE – NOTE

Florida Administrative Code Rules require that all students receiving an Associate of Science Degree and planning to transfer to a state university shall take and pass the College Level Academic Skills Test according to the schedule as listed in the calendar of instructional activities in this catalog. The minimum passing scores in effect from August 1, 1986, through July 31, 1989, for CLAST subtests are: (a) essay 4; (b) writing 270; (c) reading 270; and (d) computation 275.



THE CAREER SERVICE EMPLOYEES COMMISSION of the Florida Association of Community Colleges (FACC) met at OWCC in 1988 for the first time in the college's history.



OKALOOSA COUNTY COMMISSIONERS formally receive request from Dr. James R. Richburg, OWCC President, to relinquish any claim to coastal land that is to be traded for land to house a permanent OWCC/UWF joint educational facility.

GENERAL EDUCATION REQUIREMENTS ASSOCIATE OF SCIENCE DEGREE (26 Semester Hour Minimum)

ASSOCIATE OF SCIENCE DEGREE

	Sem. Hrs.	
Communication Skills	6	ENC 1101, 1102, LIN 1340
Humanities	3	HUM 1020, ARH 1000, MUH 1011, ARH 2050, 2051, PHI 2010, REL 2300, LIT 1201, 2164, THE 2000
Mathematics	3	MAC 1102, MAC 1140, 1114, 1154, 1411, 1412, 1413, 2233, MAP 2302, MAS 2103, MTB 1103, MGE 2202
Physical Education	4*	Any designated activity sport courses as specified under graduation requirements on page 35 unless exempted.
Science	4-8	CHM 1020, PHY 1020, GLY 1001, PHY 1053, APB 1150, 1150C/1151C, MET 1010/OCE 1005, CHM 1045C/1046C
Social Science	3	AMH 2010 or AMH 2020 or WOH 1012 or WOH 1022 or POS 1041 or AMH 1041 or POT 1002 or WOH 2240 or INR 2002 or PSY 2012 or SYG 2000, SYG 2010
Approved Electives	4	CGS 1060, STA 1014, are selected from within the above departments but not restricted to these courses.

Specialization. To complete requirements for graduation, each student must have earned at least 64 semester hours of credit with a minimum of 26 in the general education sequence and an approximate total of 38 in a specialization.

Self-contained curricula are offered by the departments for students seeking to prepare for entry-level positions in a career field upon completion of the Associate of Science Degree.

Students desiring to complete an Associate of Science Degree may in consultation with a faculty advisor select one of the following specializations:

*Maximum to be included in the 64 hours required for the degree.



A NEW IDEA, having members of the community visit the college and intern for a day, was well received on its first try. Here Buddy Looney, businessman, confers with his counterpart, Ann James, Director of Student Services.

BUSINESS

Area of Emphasis:

BUSINESS ADMINISTRATION AND MANAGEMENT*

(CIP 0506.049901)

General Education courses selected from those listed for AA degree on page 55.

Specialization Courses		Sem. Hrs.
GEB 1011	Introduction to Business	3
BUL 2111	Business Law I	3
MNA 2100	Human Relations	3
CGS 1060	Computer Literacy	3
MAR 2011	Introduction to Marketing	3
ACG 2001	Accounting I	3
ACG 2011	Accounting II	3
BUL 2112	Business Law II	3
OST 2335	Business Communications	3
MAN 2021	Management	3
ECO 2013	Economics	3

*Students must see a business advisor to select the basic and elective courses for the degree total of 64 semester hours.

Area of Emphasis:

BUSINESS ADMINISTRATION AND MANAGEMENT (BANKING OPTION)*

(CIP 0506.049901)

General Education courses selected from those listed for AA degree on page 55.

Required Specialization Courses

OWCC		AIB	Title	Sem. Hrs.
Course	Course			
ACG 2001	1000		Accounting I	3
BAN 2041	2310		Economics for Bankers	3
BAN 2800	3660		Law and Banking	3
BAN 2150	7740		Marketing for Bankers	3
BAN 2501	1350		Money and Banking	3
BAN 1004	1370		Principles of Banking	3
BAN 2716	4310		Banking Supervision	3
				21

ELECTIVE SPECIALIZATION COURSES

Remaining specialization courses are selected from the approved list 17

*Offered jointly with the American Institute of Banking (AIB).

Area of Emphasis:

COMPUTER PROGRAMMING AND ANALYSIS*

(CIP 0507.030500)

General Education courses selected from those listed for AS degree on page 55.

Specialization Courses		Sem. Hrs.
GEB 1011	Introduction to Business	3
STA 1014	Statistics	3
ACG 2001	Accounting I	3
ACG 2011	Accounting II	3
CIS 1000	Data Processing Concepts	3
COP 2000	Programming I	3
COP 2001	Programming II	3
COP 2120	COBOL Programming	3
COP 2200	FORTRAN Programming	3
OST 1141	Keyboarding	1
ECO 2013	Economics I	3
ECO 2023	Economics II	3
CGS 2510	Electronic Spreadsheets	2
CGS 3540	dBase III	2
CGS 2560	Intro. to Microcomputers/MS-DOS	1
Approved Electives		3

*Students must see a data processing advisor to select the basic and elective courses for the degree total of 64 semester hours.

Area of Emphasis:

MARKETING MANAGEMENT (Marketing Hotel-Motel, Technical Marketing, and Aviation)

General Education courses selected from those listed for AS degree on page 55.

Specialization Courses		Sem. Hrs.
GEB 1011	Introduction to Business	3
ACG 2001	Accounting I	3
BUL 2111	Business Law I	3
MKA 2021	Salesmanship	3
MKA 2511	Advertising	3
MKA 2930	Marketing Seminar I	2
ACG 2011	Accounting II	3
or BUL 2112	Business Law II	3
MAR 2011	Marketing	3
MNA 2100	Human Relations	3
MAN 2021	Management	3
ECO 2013	Economics I	3
MKA 2931	Marketing Seminar II	2
MKA 2932	Marketing Seminar III	2
CGS 1060	Computer Literacy	3

Alternate program options are recommended for students who wish to pursue careers in hotel-motel, technical sales, aviation, and other areas upon recommendation by the Department Chair and approved by the Dean of Instruction. The following courses and experiences are required for each category:

Marketing — take all courses listed above.

Hotel-Motel — ACG 2001, 2011, BUL 2112, MAN 2021, ECO 2013, CGS 1060, HFT 2010, 2250, 2261, FSS 1221

Technical Marketing — GEB 1011, MKA 2021, MKA 2511, MKA 2930, 2931, 2932, MAR 2011, MNA 2100, MAN 2021. Technical electives (14 semester hours) to be selected with faculty advisor from Commercial Data Processing, Air Conditioning, Drafting, Electronics and Graphics/Printing.

Aviation — GEB 1011, ACG 2001, BUL 2111, 2112, MAN 2021, ECO 2013, CGS 1060 plus (1) Air Frame and Power Mechanics (max of 14 credit hours) for AM T1000, 1811, 1812, 1821, 1822 or (2) credits for professional aviation (up to 14 credit hours) by transfer from an accredited college or university or by presentation of an appropriate FAA-issued certificate — credits for flight: private pilot — theory 2, flight 3; commercial pilot — theory 3, flight 3; instrument rating 3.

Area of Emphasis:
HOSPITALITY MANAGEMENT

(CIP 0206.079900)

General Education courses selected from those listed for AS degree on page 55.

Specific General Education Electives	Sem. Hrs.
CGS 1060 Computer Literacy	3
ECO 2013 Economics I	3

Specialization Courses	Sem. Hrs.
ACG 2001 Accounting I	3
ACG 2011 Accounting II	3
OST 2335 Business Communications	3
MAN 2021 Management	3
MAR 2011 Intro. to Marketing	3
MKA 2511 Intro. to Advertising	3
HFT 2010 Hospitality Management	3
BUL 2111 Business Law I	3
MKA 2021 Salesmanship	3
MNA 2100 Human Relations	3
HTF 2210 Hospitality Management Internship	6

Area of Emphasis:
REAL ESTATE MANAGEMENT*

(CIP 0206.179900)

General Education courses selected from those listed for AS degree on page 55.

Specialization Courses	Sem. Hrs.
GEB 1011 Introduction to Business	3
REE 1040 Intro. to Real Estate Principles and Practices	4
ACG 2001 Accounting I	3
ECO 2013 Economics I	3
REE 1200 Real Estate Finance	3
BUL 2111 Business Law I	3
OST 2335 Business Communications	3
MKA 2021 Salesmanship	3
REE 2300 Real Estate Improvements	3
REE 2800 Real Estate Management	3
CGS 1060 Computer Literacy	3

*Students must see a business advisor to select the basic and elective courses for the degree total of 64 semester hours.

Area of Emphasis:
OFFICE MANAGEMENT TECHNOLOGY*

(CIP 0507.040100)

General Education courses selected from those listed for AS degree on page 55.

Specialization Courses	Sem. Hrs.
OST 1211 Shorthand	3
OST 1212 Intermediate Shorthand	3
OST 2213 Advanced Shorthand	3
OST 2721 Word Processing Software I	3
OST 2722 Word Processing Software II	3
OST 2402 Secretarial Office Management	3
OST 1351 Records Management	3
OST 1110 Intermediate Typewriting	2
OST 2120 Advanced Typewriting	2
ACG 2001 Accounting I	3
OST 1601 Machine Transcription	3
BUL 2111 Business Law I	3
MAN 2021 Management	3
OST 1141 Keyboarding	1
OST 2335 Business Communications	3
CGS 1060 Computer Literacy	3



WORD PROCESSING is a popular program at OWCC, providing the latest in office equipment to train students in becoming business clerks and secretaries.

*Students must see a business advisor to select the basic and elective courses for the degree total of 64 semester hours.

**Students will be admitted to the levels of typewriting and shorthand for which they are qualified; OST 2120 and OST 2213 must be included in this degree program.

HUMAN DEVELOPMENT

Area of Emphasis:

CHILD CARE CENTER MANAGEMENT*

(CIP 0420.020502)

General Education courses selected from those listed for AS degree on page 55.

Specific General Education Courses	Sem. Hrs.
PSY 2012 Psychology	3

Specialization Courses

CHG 1220 Child Growth and Development I	3
CHD 1430 Observing and Recording Child Behavior	3
CHD 2322 Programs for Young Children	3
CHD 2432 Curriculum for Young Children I	3
HUN 2410 Child Nutrition and Health	3
HUN 2001 Nutrition	3
CHD 2433 Child Development Seminar	3
CHD 1941 Internship — Child Development	12
(May be repeated 4 times for 12 hours credit)	

Recommended Electives:

CHD 1230 Child Growth and Development II	3
CHD 2130 Orientation to CDA Credential	1
CHD 2131 Portfolio Building I	1
CHD 2132 Portfolio Building II	1
CHD 2133 Portfolio Building III	1
COA 2100 Consumer Education	3
EMS 1065C Cardiopulmonary Resuscitation	1
FAD 1123 Adults in a Changing Society	3
HUS 1400 Peer Advising	3
HSC 1400 First Aid	3



A NEW Child Care Center which meets Federal Title XX requirements is now available at OWCC.

*Students must see a Human Development faculty advisor to select basic general education and elective courses for the degree total of 64 semester hours.

TECHNOLOGY AND INDUSTRY

Area of Emphasis:

AIR CONDITIONING, HEATING, AND REFRIGERATION SYSTEMS TECHNOLOGY*

(CIP 0615.080100)

General Education courses selected from those listed for AS degree on page 55.

Specialization Courses (Min. 30 hrs.)	Sem. Hrs.
ACR 1000 Principles of Air Conditioning, Heating and Refrigeration	6
ACR 2060C Air Conditioning, Heating and Refrigeration	6
ACR 1300 Electrical Theory	6
ACR 2600 Principles of Gas, Electrical, and Solar Heating	6
ACR 2303 Electrical Controls for Air Conditioning and Refrigeration	6
ACR 2745 Commercial Air Conditioning/Refrigeration	6

Electives

ETD 1111 Drafting I (HVAC)	6
AER 2171 Automotive Air Conditioning	6
STA 1014 Statistics	3
BCN 2610 Construction Estimating	3
ENC 1210 Technical Report Writing	3
EGR 1120C Engineering Graphics	3
ARC 2307C Environmental Control Systems	3



CHECKING WORK...David Harmon, Defuniak Springs, left, discusses one of his drafting projects with Richard Szczepanski, Senior Engineer, Orlando Technology Incorporated, and Instructor, Ray Rickman. Harmon received a \$500 scholarship from OTI.

*Students must see an advisor to select the basic and elective courses for the degree total of 64 semester hours.

Area of Emphasis:

BUILDING CONSTRUCTION TECHNOLOGY*

(CIP 0615.016101)

General Education courses selected from the listing in the current college catalog for the AS degree on page 55.

Specialization Courses	Sem. Hrs.
BCN 1230 Building Construction: Materials and Processes	3
BCN 1610 Construction Estimating	3
BCN 1708 Construction Documentation	3
BCN 1529 Electrical Systems in Construction	3
BCN 1562 Plumbing and Gas Construction Practices	3
BCN 2475 Structural Systems in Construction	3
BCN 2560 Mechanical Systems in Construction	3
BCN 2721 Construction Management/Planning	3
EGN 1120C Engineering Graphics	3
ARC 2121C Architectural Drafting	3
REE 1040A Introduction to Real Estate	3

Recommended Electives

BUL 2111 Business Law I	3
ETD 2731C Structural Drafting	3
CGS 1000 Introduction to Computer Programming	3
ETD 1305 Computer/Systems Drafting	3
BC 1272 Blueprint Reading for Commercial Construction	3
ETC 1221L Surveying I	3

*Students must see an advisor to select the basic and elective courses for the degree total of 64 semester hours.

Area of Emphasis:

DRAFTING AND DESIGN TECHNOLOGY*

(CIP 0615.020200)

General Education courses selected from those listed for AS degree on page 55.

Specialization Courses (38 hours required)	Sem. Hrs.
ETD 1111 Drafting I	6
ETD 1221 Drafting II	6
ETD 1310** Intro. to Computer Drafting	1
ETD 1700** Drafting III	6
ARC 2121C Architectural Drafting	3
EGN 1130 Descriptive Geometry	3
EGN 1120C Engineering Graphics	3
ETD 1311 Computer/Systems Drafting	3
ETD 1653 Printed Circuit Board Draft	3
ETD 1801C Technical Illustration	3
ETD 2705 Advanced Mechanical Drafting	3
ETD 1712** Machine Drafting	3
ETD 1100** Electronics for Drafters	4
ETG 1941 Technical Internship	3
ETD 2351** Advanced Computer System Drafting	3
ETD 2655 Advanced Printed Circuit Board Drafting	3
CGS 2772 MS-DOS/Micro Computers	1

*Students must see an advisor to select the basic and elective courses for the degree total of 64 semester hours.

Area of Emphasis:

RESTAURANT MANAGEMENT*

(CIP 0206.070400)

General Education courses selected from those listed for AS degree on page 55.

Specialization Courses	Sem. Hrs.
FSS 1202C Beginning Food Preparation I	6
FSS 1203C Beginning Food Preparation II	6
FSS 1221 Quantity Food Preparation I	6
FSS 1222 Quantity Food Preparation II	6
HFT 2261 Restaurant Management I	6
HFT 2262 Restaurant Management II	6

Electives

FSS 1246C Commercial Baking	6
CGS 1060 Computer Literacy	3

*Students must see an advisor to select the basic and elective courses for the degree total of 64 semester hours.

Area of Emphasis:

AUTOMOTIVE SERVICE TECHNOLOGY*

(CIP 0615.080300)

General Education courses selected from those listed for AS degree on page 55.

Specialization Courses	Sem. Hrs.
AER 2112 Automotive Engines	6
AER 1120 Auto Suspension, Steering, & Brakes	6
AER 2103 Automotive Electrical	6
AER 1142 Fuel, Lub and Cooling	6
AER 1777 Diesel Repair I	3
AER 1779 Diesel Repair II	3
AER 2131 Automotive Transmissions	6

*Students must see an advisor to select the basic and elective courses for the degree total of 64 semester hours.

Area of Emphasis:

ELECTRONICS ENGINEERING TECHNOLOGY*

(CIP 0615.030301)

General Education courses selected from those listed for AS degree on page 55.

Specialization: Core	Sem. Hrs.
EET 1015C Basic Electricity/Electronics I	5
EET 1025C Basic Electricity/Electronics II	5
EET 1141C Devices and Circuits I	5
EET 1142C Devices and Circuits II	5
CET 2112C Digital Technology I	5
CET 2113C Digital Technology II	5
EET 1606C Soldering/PC Board Techniques	3

Specialization: (Options)

CET 2311C Computer Assisted Circuit Analysis	3
EET 2322C Electronic Communications	5
CET 1123C Microprocessors	5
EST 2112 Industrial Electronics	5
CET 2152 Computer Analysis and Troubleshooting	5

*Students must see an advisor to select the basic and elective courses for the degree total of 64 semester hours.

Area of Emphasis:

GRAPHIC COMMUNICATIONS*

General Education courses selected from those listed for AS degree on page 55.

**Graphic Design Technology
(CIP 0605.040200)**

Specialization Courses		Sem. Hrs.
ART 1300	Drawing I	3
ART 1201	Design I	3
GRA 1541C	Copy Preparation	4
GRA 1571C	Process Camera I	4
GRA 1573C	Process Camera II	4
GRA 1601C	Fake Color Film Assembly	3
GRA 1543C	Graphic/Commercial Design I	3
GRA 2544C	Graphic/Commercial Design II	3
GRA 2547C	Projects in Graphic Design	3
GRA 1530C	Typography	3
		33*

**Graphic Arts Technology*
(CIP 0650.080100)**

GRA 1541C	Copy Preparation	4
GRA 1542C	Phototypesetting	4
GRA 1571C	Process Camera I	4
GRA 1573C	Process Camera II	4
GRA 1601C	Fake Color Film Assembly	3
GRA 1636C	Small Offset Press Operations	4
GRA 2635C	Offset Presswork I	4
GRA 2637C	Offset Presswork II	4
GRA 2500C	Printing Material/Processes	3
		34*

Recommended Electives:

GRA 2905	Independent Study — Graphics	1
GRA 2949	Directed Work Study — Graphics	1
OST 1141	Keyboarding	1
PGY 1101C	Photography	2
EGN 1120C	Engineering Graphics	3
ETG 1941	Technical Internship	3
GRA 1706	Printing Estimating	3
GRA 2500	Printing Materials/Processes	3
GRA 2602C	Process Color Film Assembly	3
MAR 2302	Introduction to Advertising	3
GRA 1534C	Electronic Composition	4
GRA 1542C	Phototypesetting	4

*Students must see an advisor to select the basic and elective courses for the degree total of 64 semester hours.

Area of Emphasis:

WELDING TECHNOLOGY*

(CIP 0615.061000)

General Education courses selected from those listed for AS degree on page 55.

Specialization Courses		Sem. Hrs.
PMT 1106	Welding I	3
PMT 1111	Oxy-Fuel Welding	6
PMT 1121	Arc Welding I	6
PMT 1112	Advanced Oxy-Fuel Welding	6
PMT 1131	Tig Welding	6
PMT 1157	Specialty Welding	6
PMT 1161	Pipe Welding	6

*Students must see an advisor to select the basic and elective courses for the degree total of 64 semester hours.

Area of Emphasis:

FIRE SCIENCE TECHNOLOGY*

(CIP 0743.020100)

General Education courses selected from those listed for AS degree on page 55.

Specialization Courses		Sem. Hrs.
HSC 1400	First Aid	3
FFP 1000	Introduction to Fire Science	3
FFP 1100	Fire Protection Organization and Administration	3
FFP 2300	Fire Codes and Building Construction	3
FFP 2200	Fundamentals of Fire Prevention	3
FFP 2410	Fire Fighting Tactics and Strategy I	3
FFP 2420	Fire Fighting Tactics and Strategy II	3
FFP 2620	Automatic Alarm and Extinguishing Systems	3
FFP 2600	Fire Apparatus	3
FFP 2240	Arson Detection and Investigation	3
FFP 2500	Explosives and Hazardous Material	5
EMS 2119	Emergency Medical Technology I	8

*Students must see a fire science advisor to select the basic and elective courses for the degree total of 64 semester hours.

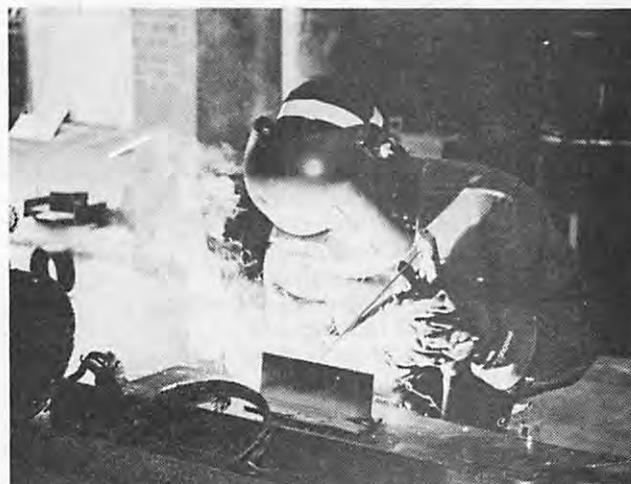

WELDING is a day and evening program at OWCC where students learn all types of industrial welding.

PUBLIC SAFETY

Area of Emphasis:

CRIMINAL JUSTICE TECHNOLOGY*

(CIP 0743.010300)

General Education courses selected from those listed for AS degree on page 55.

Specialization Courses (38 hours required)

Required Core Courses: 21 Hours		Sem. Hrs.
CCJ 1000	Introduction to Criminology	3
CCJ 1020	Introduction to Criminal Justice	3
CCJ 1210	Criminal Law	3
CCJ 1270	Criminal Procedures	3
CCJ 1935	Criminal Justice Seminar	3
CJT 2140	Introduction to Criminalistics	3
CJS 2220	Law Enforcement Photography	3
LEA 1936	Legal Research	3
LEA 2937	Rules of Evidence	3

Law Enforcement Track – Electives

CJT 1120	Crime Scene Procedures	3
CJD 1200	Law Officer Skills	3
CCJ 1400	Police Organization and Administration	3
CJT 2100	Criminal Investigations	3
CJD 2310	Police Supervision	3
CJT 2340	Police Operations	3
CJT 2430	Traffic Accident Investigations	3
CJT 2605	Traffic Homicide Investigations	3

Corrections Track – Electives

CJD 1420	Correctional Law	3
CJD 1460	Correctional Operations	3
CCJ 2300	Introduction to Corrections	3

Criminal Justice General Track – Electives

CCJ 1121	Crime Prevention	3
CCJ 1192	Crisis Intervention	3
CCJ 1500	Juvenile Delinquency	3
CJD 1501	Criminal Justice Instructor Techniques	3
CCJ 1941	Internship – Criminal Justice	3
CCJ 2070	Intro. to Computer Applications in Criminal Justice	3
CCJ 2905	Independent Study – Criminal Justice	1

*NOTE: Students must see a criminal justice advisor to select the proper elective courses and to develop a plan for completing the 38 hours of specialization and the degree total of 64 semester hours.

Area of Emphasis:

LEGAL ASSISTANT*

(CIP 0722.010300)

General Education courses selected from those listed for AS degree on page 55.

Required Core Courses (38 hours):

	Sem. Hrs.	
CCJ 1210	Criminal Law	3
CCJ 1270	Criminal Procedures	3
CCJ 1941	Internship – Criminal Justice	3
BUL 2111	Business Law I	3
BUL 2112	Business Law II	3
ACG 2001	Accounting I	3
CGS 1060	Computer Literacy	3
CRM 1020	Data Processing Concepts	3
ECO 2013	Economics I	3
GEB 1011	Intro. to Business	3
LEA 1935	Intro. to Paralegalism	3
LEA 1936	Legal Research	3
LEA 2937	Rules of Evidence	3

*Students must see a criminal justice advisor to select the proper core courses and general education electives and to develop a plan for completing the degree total of 64 semester hours.



100th MEMBER, Tonia Lawson, Purchasing, receives her Presidents Club pin from Jim Chitwood, Foundation Director, to become the 100th member of the club.



THE NEW computer classroom in the new "R" building.

ASSOCIATE OF SCIENCE DEGREE APPLIED SCIENCE OPTIONS PROGRAM REQUIREMENTS

Associate of Science Degree, Applied Science Options, are provided for skill training in industrial technical, business, and child care. Additional training is provided each student in mid-management areas to better prepare for advancement or a supervisory position.

Course in Residence. (Credit hours taken at Okaloosa-Walton Community College). Minimum requirement of courses taken in residence for Applied Science Options at Okaloosa-Walton Community College is normally 15 semester hours of credit. SIXTY-FOUR (64) HOURS ARE REQUIRED FOR GRADUATION.

General Education. The general education requirements for students selecting Applied Science Options with the Associate of Science degree at Okaloosa-Walton Community College may be reduced to a minimum of 16 semester hours of required general education credit to be selected from four of the five following areas, subject to approval of the department chairman.

NOTE – NOTE – NOTE – NOTE – NOTE

Florida Administrative Code RULES REQUIRE THAT ALL STUDENTS RECEIVING an Associate of Science Degree who plan to transfer to a state university shall take and pass the College Level Academic Skills Test according to the schedule as listed in the calendar of instructional activities in this catalog. The minimum passing scores in effect from August 1, 1986, through July 31, 1989, for CLAST subtests are: (a) essay 4; (b) writing 270; (c) reading 270; and (d) computation 275.

GENERAL EDUCATION REQUIREMENTS (16 Semester Hour Minimum)

	Sem. Hrs.	Course Selections
Communications Skills.....	3	ENC 1101, 1102, LIN 1340
Mathematics.....	3	MAC 1102, MAC 1140, 1114, 1154, MAP 2302, MAC 1411, MAC 1412, MAC 1413, MAC 2233, MAS 2103, MTB 1103, MGF 2202
Science.....	4-3	CHM 1020, PHY 1020, GLY 1001, PHY 1053, 1054, APB 1150, APB 1150C, APB 1151C, MET 1010/OCE 1005
Social Science.....	3	AMH 2010 or AMH 2020 or WOH 1012 or WOH 1022 or POS 1041 or POS 1042 or AMH 1041 or POT 1002 or WOH 2240 or INR 2002 or PSY 2012 or SYG 2000
Approved Electives.....	4-3	CGS 1060, STA 1014 or selected from the above departments, plus Humanities courses as listed under Gen. Ed. for AS degree, but not restricted to these courses.

Specialization. To complete requirements for graduation, each student must have earned at least 64 semester hours of credit with a minimum of 16 in the general education sequence and an approximate total of 48 in a specialization.

The student is to plan a specialized program in consultation with a departmental advisor.

Self-contained curricula are offered by the departments for students seeking to prepare themselves for entry-level positions in a career field upon completion of the degree.

Students desiring to complete an Applied Science Option may, in consultation with a faculty advisor, select one of the following specializations:

OCCUPATIONAL ELECTIVES ASSOCIATE OF SCIENCE DEGREE (APPLIED SCIENCE OPTIONS) TECHNOLOGY, INDUSTRY, AND PUBLIC SERVICES DEPARTMENT

OCCUPATIONAL ELECTIVES / ASSOCIATE OF SCIENCE DEGREE

Occupational Electives. The following courses listed below would be common to any of the Applied Science Options as occupational electives:

ACG 2001	Accounting I	HSC 1400	First Aid
BUL 2111	Business Law I	MKA 2021	Salesmanship
COA 2100	Consumer Education	MKA 2511	Introduction to Advertising
EGN 1120C	Engineering Graphics	MTB 1103	Business Math
ENC 1210	Technical Report Writing	GEB 1011	Introduction to Business
OST 1100*	Typewriting I	MAN 2021	Management
OST 2335	Business Communications	MNA 2100	Human Relations
FAD 1123	Adults in a Changing Society	STA 1014	Statistics

Other courses by programs which might serve as occupational electives for the following are:

Air Conditioning: Beginning course(s) in Drafting, Welding, Electronics Technology, Auto Mechanics programs, AER 2171, and ACR 2307C.

Auto Mechanics: Beginning course(s) in Welding, Electronics Technology, Air Conditioning, and/or Air Frame and Power Mechanics courses: ATM 1000, 1351, 1821, 1822, 1823, 1824.

Restaurant Management: HFT 2010 Hotel-Motel Management I, HFT 2250 Hotel-Motel Management II, FSS 1246 Commercial Banking, and HSC 1400 First Aid.

Drafting and Design: COP 2200-FORTRAN Programming, COP 2170-Basic Language Programming, CIS 1000 Data Processing Concepts, EGN 1130C-Descriptive Geometry, EET 1015C-Electronics I, EET 1025C-Electronics 2, and ETD 2614C-Electronic Drafting and Fabrication.

Electronics: COP 2200-FORTRAN Programming, COP 2170-Basic Language Programming, CIS 1000-Data Processing Concepts, ETD 2614C-Electronic Drafting and Fabrication, and ETD 1111-Drafting I.

Welding: Beginning course(s) in Air Conditioning, Auto Mechanics, Electronics Technology and/or EGN 1130C-Descriptive Geometry, ETD 1111, Drafting I, ETD 1221-Drafting II, MTR 1140-Pipe Welding, and PMT 1175-Pipe Fitting.

Other courses may be approved upon written recommendation to the Dean of Instruction by the department advisor.

*Required for Graphics/Printing students.

Area of Emphasis:

OFFICE SYSTEMS TECHNOLOGY*

(CIP 0507.060300)

General Education courses selected from those listed on page 62.

Specialized Courses		Sem. Hrs.
OST 1211	Shorthand	3
MTB 1103	Business Math	3
GEB 1011	Introduction to Business	3
OST 1601	Machine Transcription	3
BUL 2111	Business Law I	3
OST 2335	Business Communications	3
MNA 2100	Human Relations	3
CGS 1060	Computer Literacy	3
OST 2402	Secretarial Office Management	3
OST 1110	Intermediate Typewriting	3
OST 2120	Advanced Typewriting	3
OST 1351	Records Management	3
OST 2721	Word Processing Software I	3
OST 2722	Word Processing Software II	3
OST 1212	Intermediate Shorthand	3
OST 2213	Advanced Shorthand	3
BUL 2112	Business Law II	3

*Students must see a business education advisor to select the basic and elective courses for the degree total of 64 semester hours.

Area of Emphasis:

BUSINESS ADMINISTRATION AND MANAGEMENT (BANKING OPTION)*

(CIP 0506.049901)

General Education courses selected from those listed on page 62.

Required Specialization Courses

OWCC Course	AIB Course	Title	Sem. Hrs.
ACG 2001	1000	Accounting I	3
BAN 2041	2310	Economics for Bankers	3
BAN 2800	3660	Law and Banking	3
BAN 2150	7740	Marketing for Bankers	3
BAN 2501	1350	Money and Banking	3
BAN 1004	1370	Principles of Banking	3
BAN 2716	4310	Banking Supervision	3
BAN 1204	6350	Commercial Lending	3
BAN 2210	6920	Analyzing Financial Statements	3
BAN 1175	7008	Consumer Lending	3
			30

ELECTIVE SPECIALIZATION COURSES

Remaining specialization courses are selected from the approved list 18

*Offered jointly with the American Institute of Banking (AIB).

Area of Emphasis:

COMPUTER PROGRAMMING AND ANALYSIS*

(CIP 0507.030500)

General Education courses selected from those listed on page 62.

Specialization Courses		Sem. Hrs.
GEB 1011	Introduction to Business	3
ACG 2001	Accounting I	3
ACG 2011	Accounting II	3
CIS 1000	Data Processing Concepts	3
COP 2120	COBOL Programming	3
COP 2200	FORTRAN Programming	3
BUL 2111	Business Law I	3
MNA 2100	Human Relations	3
MAN 2021	Management	3
ECO 2013	Economics I	3
MAC 1140	Pre-Calculus Algebra	3
COP 2000	Programming I	3
OST 1141	Keyboarding	1
COP 2001	Programming II	3

*Students must see a data processing advisor to select the basic and elective courses for the degree total of 64 semester hours.

Area of Emphasis:

REAL ESTATE MANAGEMENT*

(CIP 0206.179900)

General Education courses selected from those listed on page 62.

Specialization Courses (select 48 hours)		Sem. Hrs.
MTB 1103	Business Math	3
GEB 1011	Introduction to Business	3
REE 1200	Real Estate Finance	3
REE 1040	Intro. to Real Estate Course I	4
REE 1200	Real Estate Finance	3
ACG 2001	Accounting I	3
ACG 2011	Accounting II	3
BUL 2111	Business Law I	3
BUL 2112	Business Law II	3
OST 2335	Business Communications	3
MKA 2021	Salesmanship	3
MNA 2100	Human Relations	3
ECO 2013	Economics I	3
ECO 2023	Economics II	3
CGS 1060	Computer Literacy	3
MAR 2011	Intro. to Marketing	3
MKA 2511	Intro. to Advertising	3

*Students must see business education to select the basic and elective courses for the degree total of 64 semester hours.

Area of Emphasis:
**WORD PROCESSING
 TECHNOLOGY***

(CIP 0507.060801)

General Education courses selected from those listed on page 62.

Specialization Courses		Sem. Hrs.
OST 1110	Typewriting II	2
OST 1351	Filing	3
MTB 1103	Business Mathematics	3
GEB 1011	Introduction to Business	3
ACG 2001	Accounting I	3
OST 2120	Typewriting III	2
BUL 2111	Business Law I	3
BUL 2112	Business Law II	3
OST 2335	Business Communications	3
OST 2401	General Office Practice	3
MAN 2100	Human Relations	3
MAN 2021	Management	3
OST 1701	Word Processing Introduction Theory	3
OST 1601	Machine Transcription	3
OST 2721	Word Processing Editing I	3
OST 2722	Word Processing Editing II	3
CGS 1060	Computer Literacy	3

*Students must see a business advisor to select the basic and elective courses for the degree total of 64 semester hours.



SYMPHONY MEMBERS volunteer their time to perform and then let children handle the instruments to encourage them to take an interest in the arts and hopefully become artists.



THIS STUDENT learns dictation by listening to a tape and then transcribing the notes. Specializations such as legal and medicine are available to the student.

HUMAN DEVELOPMENT

Area of Emphasis:
**CHILD CARE CENTER
 MANAGEMENT***

(CIP 0420.020502)

General Education courses selected from those listed on page 62.

Specialization Courses		Sem. Hrs.
CHD 1220	Child Growth and Development	3
CHD 1430	Observing and Recording Child Behavior	3
HUN 2410	Child Nutrition and Health or	3
HUN 2001	Nutrition	3
CHD 2322	Programs for Young Children	3
CHD 2432	Curriculum for Young Children I	3
CHD 2433	Child Development Seminar	3
CHD 1941	Internship — Child Development (May be repeated 4 times for 12 hours credit)	12

Recommended Electives

HSC 1400	First Aid	3
CHD 1230	Child Growth and Development II	3
HUS 1400	Peer Advising	3
MUH 1011	Music for General Education	3
FAD 1123	Adults in a Changing Society	3
CHD 2130	Orientation to CDA Credential	3
CHD 2131	CDA Portfolio Building I	1
CHD 2132	CDA Portfolio Building II	1
CHD 2133	CDA Portfolio Building III	1
EMS 1065C	Cardiopulmonary Resuscitation	1

*Students must see human development faculty advisor to select basic general education and elective courses for the degree total of 64 semester hours.

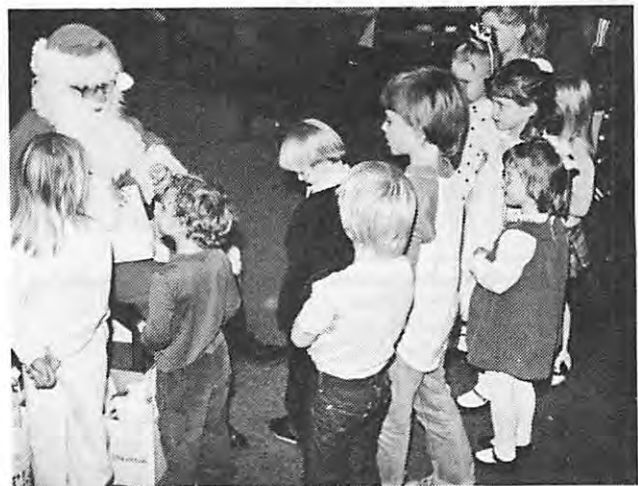

THE ANNUAL CHRISTMAS PARTY found Santa the center of attention.

TECHNOLOGY AND INDUSTRY

Area of Emphasis:

AIR CONDITIONING, HEATING, AND REFRIGERATION SYSTEMS TECHNOLOGY*

(CIP 0615.080100)

General Education courses selected from those listed on page 62.

Specialization Courses	Sem. Hrs.
ACR 1300 Electrical Theory	6
ACR 1000 Principles of Air Conditioning, Heating and Refrigeration	6
ACR 2600 Principles of Gas, Electrical, and Solar Heating	6
ACR 2060 Air Conditioning, Heating, and Refrigeration	6
ACR 2303 Electrical Controls for Air Conditioning and Refrigeration	6
ACR 2745 Commercial Air Conditioning and Refrigeration	6
Approved Occupational Electives	12

*Students must see an advisor to select the basic and elective courses for the degree total of 64 semester hours.

Area of Emphasis:

AUTOMOTIVE SERVICE TECHNOLOGY*

(CIP 0615.080300)

General Education courses selected from those listed on page 62.

Specialization Courses	Sem. Hrs.
AER 2112 Automotive Engines	6
AER 1120 Auto Suspension, Steering, and Brakes	6
AER 2103 Automotive Electrical	6
AER 1142 Fuel, Lub and Cooling	6
AER 1777 Diesel Repair 1	3
AER 1779 Diesel Repair 2	3
AER 2131 Automotive Transmissions	6
Approved Occupational Electives	12

*Students must see an advisor to select the basic and elective courses for the degree total of 64 semester hours.

Area of Emphasis:

RESTAURANT MANAGEMENT*

(CIP 0206.070400)

General Education courses selected from those listed on page 62.

Specialization	Sem. Hrs.
FSS 1202C Beginning Food Preparation I	6
FSS 1203C Beginning Food Preparation II	6
FSS 1221 Quantity Food Preparation I	6
FSS 1222 Quantity Food Preparation II	6
HFT 2261 Restaurant Management I	6
HFT 2262 Restaurant Management II	6
Approved Occupational Electives	12

*Students must see an advisor to select the basic and elective courses for the degree total of 64 semester hours.

Area of Emphasis:

GRAPHIC COMMUNICATIONS*

General Education courses selected from those listed on page 62.

Graphic Design Technology* (CIP 0605.040200)

Specialization Courses	Sem. Hrs.
ART 1300 Drawing I	3
ART 1201 Design I	3
GRA 1541C Copy Preparation	4
GRA 1571C Process Camera I	4
GRA 1573C Process Camera II	4
GRA 1601C Fake Color Film Assembly	3
GRA 1543C Graphic/Commercial Design I	3
GRA 2544C Graphic/Commercial Design II	3
GRA 2547C Projects in Graphic Design	3
PGY 1101C Photography	3
GRA 1530C Typography	3
	36*

*(Select 12 additional semester hours from the approved "Recommended Electives").



UPDATE WORKSHOP was held on campus by Tektronix Inc. on the Tektronix 2400 Digital Storage Scope under the sponsorship of the college's electronics program.

Graphic Arts Technology*
(CIP 0650.080100)

GRA 1541C	Copy Preparation	4
GRA 1542C	Phototypesetting	4
GRA 1571C	Process Camera I	4
GRA 1573C	Process Camera II	4
GRA 1601C	Fake Color Film Assembly	3
GRA 1636C	Small Offset Press	4
GRA 2635C	Offset Presswork I	4
GRA 2637C	Offset Presswork II	4
GRA 2500C	Printing Material/Processes	3
PGY 1101C	Photography	2
		36*

* (Select 12 additional semester hours from the approved "Recommended Electives").

Recommended Electives:

GRA 2905	Independent Study — Graphics	1
GRA 2949	Directed Work Study — Graphics	1
OST 1141	Keyboarding	1
PGY 1101C	Photography	2
EGN 1120C	Engineering Graphics	3
ETC 1941	Technical Internship	3
GRA 1706	Printing Estimating	3
GRA 2500	Printing Materials/Processes	3
GRA 2602C	Process Color Film Assembly	3
MAR 2302	Introduction to Advertising	3
GRA 1534C	Electronic Composition	4
GRA 1542C	Phototypesetting	4

* Students must see an advisor to select the basic and elective courses for the degree total of 64 semester hours.

Area of Emphasis:

DRAFTING AND DESIGN TECHNOLOGY*

(CIP 0615.020200)

General Education courses selected from those listed on page 62.

Specialization Courses (Select 48 hours): Sem. Hrs.

ETD 1111	Drafting I	6
ETD 1221	Drafting II	6
ETD 1310	Intro. to Computer Drafting	1
ETD 1700	Drafting III	6
TED 1801	Technical Illustration	3
ETD 1653	Printed Circuit Board Drafting	3
EGN 1130	Descriptive Geometry	3
EGN 1120C	Engineering Graphics	3
ETD 1311	Computer/Systems Drafting	3
ARC 2121C	Architectural Drafting	3
ETD 2705	Advanced Mechanical Drafting	3
ETD 1712	Machine Drafting	3
ETE 1100	Electronics for Drafters	4
ETG 1941	Technical Internship	3
ETD 2655	Advanced Printed Circuit Board Drafting	3
ETD 2351	Advanced Computer Systems Drafting	3
CGS 2772	MS-DOS/Micro Computers	1

* Students must see an advisor to select the basic and elective courses for the degree total of 64 semester hours.

Area of Emphasis:

ELECTRONICS ENGINEERING TECHNOLOGY*

(CIP 0615.030301)

General Education courses selected from those listed on page 62.

Specialization: Core

	Sem. Hrs.	
EET 1015C	Basic Electricity/Electronics I	5
EET 1025C	Basic Electricity/Electronics II	5
EET 1141C	Devices and Circuits I	5
EET 1142C	Devices and Circuits II	5
CET 2112C	Digital Technology I	5
CET 2113C	Digital Technology II	5
CET 2311C	Computer Assisted Circuit Analysis	3
EET 1606C	Soldering/PC Board Techniques	3

Specialization: Options (Students chooses three)

EET 2322C	Electronics Communications	5
CET 2152	Computer Analysis and Troubleshooting	5
CET 1123C	Microprocessors	5
EST 2112	Industrial Electronics	5

* Students must see an advisor to select the basic and elective courses for the degree total of 64 semester hours.

Area of Emphasis:

WELDING TECHNOLOGY*

(CIP 0615.061000)

General Education courses selected from those listed on page 62.

Specialization Courses

(Select 36 hours plus electives)

	Sem. Hrs.	
PMT 1106	Welding I	3
PMT 1111	Oxy-Fuel Welding	6
PMT 1121	Arc Welding I	6
PMT 1112	Advanced Oxy-Fuel Welding	6
PMT 1131	Tig Welding	6
PMT 1157	Specialty Welding	6
PMT 1161	Pipe Welding	6
PMT 2122	Arc Welding II	6
	Approved Occupational Electives	12

* Students must see an advisor to select the basic and elective courses for the degree total of 64 semester hours.



OUTREACH, the college's program to reach high school students to let them know what their college options are and that college is attainable, is shown in action as a student uses sign language to communicate what is being said.

OCCUPATIONAL ELECTIVES / ASSOCIATE OF SCIENCE DEGREE

PUBLIC SAFETY

Area of Emphasis:

CRIMINAL JUSTICE TECHNOLOGY*

(CIP 0743.010300)

General Education courses selected from those listed on page 62.

Specialization Courses (48 hours required)

Required Core Courses: 21 Hours Sem. Hrs.

CCJ 1000	Crime and Delinquency	3
CCJ 1020	Introduction to Criminal Justice	3
CCJ 1210	Criminal Law	3
CCJ 1270	Criminal Procedures	3
CCJ 1935	Criminal Justice Seminar	3
CCJ 2140	Introduction to Criminalistics	3
CJT 2220	Law Enforcement Photography	3
LEA 1936	Legal Research	3

Law Enforcement Track – Electives

CCJ 1120	Crime Scene Procedures	3
CCJ 1200	Law Officer Skills	3
CCJ 1140	Police Organization and Administration	3
CJT 2100	Criminal Investigation	3
CJD 2310	Police Supervision	5
CJT 2340	Police Operations	3
CJT 2430	Traffic Accident Investigations	3
CJD 2605	Traffic Homicide Investigations	3

Corrections Track – Electives

CJD 1420	Correctional Law	3
CJD 1460	Correctional Operations	3
CCJ 2300	Introduction to Corrections	3

Criminal Justice General Track – Electives

CCJ 1121	Crime Prevention	3
CCJ 1192	Crisis Intervention	3
CCJ 1500	Juvenile Delinquency	3
CJD 1501	Criminal Justice Instructor Techniques	3
CCJ 1941	Internship – Criminal Justice	3
CCJ 2070	Intro. to Computer Applications in Criminal Justice	3
CCJ 2905	Independent Study – Criminal Justice	1
LEA 2937	Rules of Evidence	3

*Students must see a criminal justice advisor to select the basic and elective courses for the degree total of 64 semester hours.

Area of Emphasis: FIRE SCIENCE*

(CIP 0743.020100)

General Education courses selected from those listed on page 62.

Specialized Courses (48 hours required)

Required Core Courses: 40 Hours		Sem. Hrs.
FFP 1000	Introduction to Fire Science	3
FFP 1100	Fire Protection Organization & Administration	3
FFP 2200	Fundamentals of Fire Prevention	3
FFP 2240	Arson Detection & Investigation	3
FFP 2300	Fire Codes & Building Construction	3
FFP 2410	Fire Fighting Tactics & Strategy I	3
FFP 2420	Fire Fighting Tactics & Strategy II	3
FFP 2500	Explosives & Hazardous Material I	3
FFP 2501	Explosives & Hazardous Material II	3
FFP 2600	Fire Apparatus	3
FFP 2620	Automatic Alarm & Extinguishing Systems	3
FFP 2640	Fire Service Hydraulics	3
EMS 1059	First Responder	4

Recommended Electives: (Select 8 Semester Hours)

EMS 2119C	Emergency Medical Technology	8
SPC 1600	Speech	3
ENC 1210	Technical Writing	3
MNA 2100	Human Relations	3
MAN 2021	Management	3
HLP 1081	Wellness	3

*Students must see a fire science advisor to select the basic elective courses for the degree total of 64 semester hours.



MEMBERS OF THE COMMITTEE OF 100 receive the college's Industry-Education Partnership Awards at their annual banquet held on campus in 1988. The committee is composed of influential members from the community who dedicate themselves to economic development.

OCCUPATIONAL CERTIFICATE PROGRAMS*

Certificates are issued for completion of one year of skill training (30 to 36 semester hours) in the program areas appearing on this and on the following several pages.

Admission requirements are the same as for the AS degree, Applied Science Options.

Each graduate must be in attendance at OWCC during his/her last term. A grade-point average of not less than "C" must be obtained on the accumulative total of all courses required for a specific occupational certificate. The minimum grade-point average for all required occupational certificate course work attempted at OWCC must be 2.0 ("C").

Students must make formal application for certificates on the proper form furnished by the Registrar.

Students desiring information or wishing to enter one of the certificate programs are to see the department chair of the department which has the program or see a faculty advisor in that department.

Appropriate course substitutions may be authorized by the Dean of Instruction, upon written recommendation by the department chair.



LEARNING to make a go of it again, these women are learning to identify skills and how to support themselves through a special program offered by the college.



A COMMERCIAL FOODS student prepares salads for lunch.

*NOTE — These programs are NOT approved for veterans training. They are local incentive awards given for completion of a specified portion of an Associate of Science Degree.

COMPUTER PROGRAMMING AND ANALYSIS

(CIP 0507.030500)

Course	Course Title	Sem. Hrs.
CIS 1000	Data Processing Concepts	3
COP 2120	COBOL Programming	3
COP 2200	FORTRAN Programming	3
MNA 2100	Human Relations	3
COP 2000	Programming I	3
COP 2001	Programming II	3
OST 1141	Keyboarding	1
MAC 1140	Pre-Calculus Algebra	3
	Technical or Business Electives	9

REAL ESTATE MANAGEMENT

(CIP 0206.179900)

MTB 1103	Business Math	3
REE 1200	Real Estate Finance	3
REE 1040	Introduction to Real Estate: Course I	4
ACG 2001	Accounting I	3
ACG 2021	Accounting II	3
BUL 2111	Business Law	3
OST 2335	Business Communications	3
MKA 2021	Salesmanship	3
MNA 2100	Human Relations	3
	Business Education Electives	3

OFFICE SYSTEMS TECHNOLOGY

(CIP 0507.060300)

OST 1110	Intermediate Typewriting	2
OST 2120	Advanced Typewriting	2
OST 1211	Shorthand	3
OST 1212	Intermediate Shorthand	3
OST 2213	Advanced Shorthand	3
OST 1351	Records Management	3
OST 2721	Word Processing Software I	3
OST 2722	Word Processing Software II	3
OST 2402	Secretarial Office Management	3
MTB 1103	Business Math	3
OST 1601	Machine Transcription	3
OST 2335	Business Communication	3
ACG 2001	Accounting I	3
CGS 1060	Computer Literacy	3

BUSINESS ADMINISTRATION AND MANAGEMENT (BANKING OPTION)*

(CIP 0506.049901)

Required Specialization Courses

OWCC		AIB		Title	Sem. Hrs.
Course	Course	Course	Course		
ACG 2001	1000	1000		Accounting I	3
BAN 2041	2310	2310		Economics for Bankers	3
BAN 2800	3660	3660		Law and Banking	3
BAN 2150	7740	7740		Marketing for Bankers	3
BAN 2501	1350	1350		Money and Banking	3
BAN 1004	1370	1370		Principles of Banking	3
BAN 2716	4310	4310		Banking Supervision	3
BAN 1204	6350	6350		Commercial Lending	3
BAN 2210	6920	6920		Analyzing Financial Statements	3
BAN 1175	7008	7008		Consumer Lending	3
					30

ELECTIVE SPECIALIZATION COURSES

Remaining specialization courses are selected from the approved list 6

*Offered jointly with the American Institute of Banking (AIB).

WORD PROCESSING TECHNOLOGY

(CIP 0507.06080)

OST 1110	Typewriting II	2
OST 1351	Filing	3
MTB 1103	Business Mathematics	3
ACG 2001	Accounting I	3
OST 2120	Typewriting III	2
OST 2335	Business Communications	3
MAN 2021	Management	3
OST 1601	Machine Transcription	3
OST 2721	Word Processing: Editing I	3
OST 2722	Word Processing: Editing II	3
CGS 1060	Computer Literacy	3
OST 2401	General Office Practice	3



FOOD SERVICES, cafeteria style, plus grill specialties, a salad bar, prepared salads and cold sandwiches are available in the College Mall. Here Sherry Brooks, cashier, waits on a student.

HUMAN DEVELOPMENT

CHILD CARE CENTER MANAGEMENT

(CIP 0420.020502)

CHD 1220	Child Growth and Development I	3
CHD 1430	Observing and Recording Child Behavior	3
CHD 2432	Curriculum for Young Children I	3
HUN 2410	Child Nutrition and Health	3
FAD 1123	Adults in a Changing Society	3
HUS 1400	Peer Advising	3
COA 2100	Consumer Education	3
CHD 1941	Internship — Child Development (May be repeated 3 times for 9 credit hours)	3
CHD 2433	Child Development Seminar	3
CHD 1230	Child Growth and Development II	3
CHD 2322	Programs for Young Children	3

TECHNOLOGY AND INDUSTRY

AIR CONDITIONING, HEATING, AND REFRIGERATION SYSTEMS TECHNOLOGY

(CIP 0615.080100)

Course	Course Title	Sem. Hrs.
ACR 1300	Electrical Theory	6
ACR 1000	Principles of Air Conditioning, Heating, and Refrigeration	6
ACR 2600	Principles of Gas, Electrical, and Solar Heating	6
ACR 2060	Air Conditioning, Heating and Refrigeration	6
ACR 2303	Electrical Controls for Air Conditioning and Refrigeration	6
ACR 2745	Commercial Air Conditioning and Refrigeration	6

AUTOMOTIVE SERVICE TECHNOLOGY

(CIP 0615.080300)

AER 2112	Automotive Engines	6
AER 1120	Auto Suspension, Steering, and Brakes	6
AER 2103	Automotive Electrical	6
AER 1142	Fuel, Lube and Cooling	6
AER 1777	Diesel Repair I	3
AER 1779	Diesel Repair II	3
AER 2131	Automotive Transmissions	6

RESTAURANT MANAGEMENT

(CIP 0206.070400)

FSS 1202C	Beginning Food Preparation I	6
FSS 1203C	Beginning Food Preparation II	6
FSS 1221	Quantity Food Preparation I	6
FSS 1222	Quantity Food Preparation II	6
HFT 2261	Restaurant Management I	6
HFT 2262	Restaurant Management II	6

DRAFTING AND DESIGN TECHNOLOGY*

(Select 36 hours — 27 core and 9 electives)

(CIP 0615.020200)

ETD 1111	Drafting I	6
ETD 1221	Drafting II	6
ETD 1310*	Intro. to Computer Drafting	1
ETD 1700*	Drafting III	6
ARC 2121C	Architectural Drafting	3
EGN 1130C	Descriptive Geometry	3
EGN 1120C	Engineering Graphics	3
ETD 1311*	Computer/Systems Drafting	3
ETD 1653	Printed Circuit Board Drafting	3
ETD 1801C	Technical Illustration	3
ETD 2705	Advanced Mechanical Drafting	3
ETD 1712*	Machine Drafting	3
ETD 1100	Electronics for Drafters	4
ETD 2351*	Advanced Computer Systems Drafting	3
ETD 2655	Advanced Printed Circuit Board Drafting	3

*Requires Core Courses

ELECTRONICS ENGINEERING TECHNOLOGY

(CIP 0615.030301)

Core:

EET 1015C	Basic Electricity/Electronics I	5
EET 1025C	Basic Electricity/Electronics II	5
EET 1141C	Devices and Circuits I	5
EET 1142C	Devices and Circuits II	5
CET 2112C	Digital Technology I	5
EET 1606C	Soldering/PC Board Techniques	3

Options: *

EET 2322C	Electronic Communications	5
CET 2113C	Digital Technology II	5
CET 1123C	Advanced Microprocessors	5
EST 2112	Industrial Electronics	5
CET 2152	Computer Analysis and Troubleshooting	5

*Students must select 10 hours of option/elective courses in consultation with an advisor.

GRAPHIC COMMUNICATIONS

Graphic Design Technology (CIP 0605.040200)

ART 1300	Drawing I	3
ART 1201	Design I	3
GRA 1541C	Copy Preparation	4
GRA 1571C	Process Camera I	4
GRA 1573C	Process Camera II	4
GRA 1601C	Fake Color Film Assembly	3
GRA 1543C	Graphic/Commercial Design I	3
GRA 2544C	Graphic/Commercial Design II	3
GRA 2547C	Projects in Graphic Design	3
GRA 1530C	Typography	3

Graphic Arts Technology (CIP 0650.080100)

GRA 1541C	Copy Preparation	4
GRA 1542C	Phototypesetting	4
GRA 1571C	Process Camera I	4
GRA 1573C	Process Camera II	4
GRA 1601C	Fake Color Film Assembly	3
GRA 1636C	Small Offset Press	4
GRA 2635C	Offset Presswork I	4
GRA 2637C	Offset Presswork II	4
GRA 2500C	Printing Material/Processes	3

WELDING TECHNOLOGY

(CIP 0615.061000)

PMT 1111	Oxy-Fuel Welding	6
PMT 1121	Arc Welding I	6
PMT 1112	Advanced Oxy-Fuel Welding	6
PMT 1131	Tig Welding	6
PMT 1157	Specialty Welding	6
PMT 2122	Arc Welding II	6

PUBLIC SERVICES

LEGAL ASSISTANT

(CIP 0722.010300)

(Select 36 hours)

CCJ 1210	Criminal Law	3
CCJ 1270	Criminal Procedures	3
CCJ 1941	Internship — Criminal Justice	3
BUL 2111	Business Law I	3
BUL 2112	Business Law II	3
ACG 2001	Accounting I	3
CGS 1060	Computer Literacy	3
CIS 1000	Data Processing Concepts	3
ECO 2013	Economics I	3
GEB 1011	Intro. to Business	3
LEA 1935	Intro. to Paralegalism	3
LEA 1936	Legal Research	3
LEA 2937	Rules of Evidence	3



HAVING FUN and getting an education along with it is what college is all about.



BRAVING THE COLD. This bunch showed up for the 25th Anniversary Walk-a-Thon Feb. 23, one of the coldest days of the year.

CONTINUING EDUCATION OPTIONS

The Continuing Education Division can organize and present short courses, long courses, workshops, seminars, meetings, and conferences. Such activities can take place in your facilities, in our facilities, or in any other suitable facilities that can be arranged. We can use your personnel as instructors, ours, or employ qualified outside personnel. The college's principal vehicles for delivering continuing education are **Supplemental Education**, **Lifelong Learning**, and **Self-Supporting** activities.

Supplemental Education (Professional/Technical Development)

This option is used when updating job related knowledge and skills is the goal. Courses, workshops, and/or seminars can be developed to meet the specific needs of a given organization or company. Supplemental courses, workshops, or seminars can be as long or as short as necessary to meet the need. They can be scheduled for days, nights, and/or weekends and housed in any suitable facility that is available.

Lifelong Learning (Personal Development)

This option is used to provide for enrichment needs that do not relate directly to job skills or knowledge. A wide range of avocational and personal, public, and community interest oriented activities can be presented under this category in the form of courses, workshops, and/or seminars. Lifelong Learning activities can be as long or as short as necessary to meet the need. They can be scheduled for days, nights, or weekends and housed in any suitable facility that is available.

Self-Supporting Activities

This option is used when the need is to host a conference/meeting, provide recreation/leisure courses, or for any other need not met by the Supplemental or Lifelong Learning options.



FIFTH GRADERS learn about good music at the annual concert put on by the Northwest Florida Symphony Orchestra for fifth graders in Okaloosa and Walton counties.

ADULT GENERAL and CONTINUING EDUCATION

ADULT BASIC EDUCATION

Adult Basic Education at OWCC consists of individualized and small group instruction leading to a mastery of the basic skills needed by adults to function in today's complex society. Persons completing this program normally take the General Educational Development (GED) Test. (See Fee Schedule, page 14, for costs).

GENERAL EDUCATION DEVELOPMENT (GED) AND ADULT HIGH SCHOOL DIPLOMA

Course work for high school units and to prepare individuals without high school diplomas for the GED Test is available. Persons passing the GED Test, as well as those who earn sufficient credits by class attendance and pass the state exam, are awarded a high school diploma by the State of Florida.

Selected continuing education courses meeting 45 contact hours earn 4.5 continuing education units and may also earn 1/2 unit applicable toward a high school diploma. A program of study for adult high school students will be developed, upon request, by an OWCC counselor/advisor that specifies the appropriate academic and elective high school units.

VOCATIONAL PREPARATORY

Vocational Preparatory course work is offered for the specific purpose of preparing individuals for successful completion of vocational/occupational programs and for advancement or upgrading in their occupations. Students pursuing occupational program objectives should seek counselor/advisor assistance with regard to placement in Vocational Preparatory courses.

COLLEGE PREPARATORY

College Preparatory courses are provided for high school graduates who are identified as needing additional academic preparation in computation and communications before pursuit of degree-credit college courses. These courses provide competency-based instruction for the development of the prerequisite skills in reading, writing, mathematical reasoning and logical thinking for effective pursuit of **degree-credit** college courses.

Students whose entry level test scores are **below** the levels specified in State Board rules for taking college level courses in English and mathematics are required to enroll in the appropriate college prep courses before attempting college transfer work in those subjects. During their first term, full-time students who apply to enter degree programs and have registered for 12 or more credits, or part-time students who have accumulated at least 12 credits, shall begin prep instruction based on the placement scores.

Students enrolled in college prep courses may, also, take courses at the same time in other curriculum areas where qualified. (See "Entry-Level Testing" under the Admissions section of the catalog for further information.) The following college prep courses are offered each term:

ENC1000A College Prep English

3 cr/75 class hours

MAT1024A College Prep Algebra

3 cr/75 class hours

REA1000A College Prep Reading

3 cr/75 class hours

Completing a college prep course satisfactorily will meet the requirement for moving forward into the corresponding college level course. Earning a satisfactory score on one of the entry level tests will, also, satisfy this requirement.

Students whose entry test scores are **above** the minimum level may take a college prep course if such enrollment would enhance their opportunities for future academic success. Students are reminded that college prep courses earn "S" and "U" grades, and credits earned in these courses do not count toward degree totals. Also, certain financial aid categories (including VA) will require justification for taking a college prep course if entry scores are above the cutoff level -- the college prep teacher will assist with any required documentation which the Registrar and/or Financial Aid offices may request.

By State Board rule, students may not enroll for more than three semesters in each skill area to complete college prep instruction. Students who withdraw officially before the midpoint of a semester may be considered to have **not** enrolled that semester for purposes of this limitation. Students who withdraw officially at or after the midpoint of a semester shall be considered to have enrolled that semester unless the withdrawal can be documented as due to reasons of personal hardship or disability or under major extenuating circumstances. Requests for waiver of the three-term limit should be submitted to the Dean of Instruction for review and approval.

FLORIDA'S STATEWIDE COURSE NUMBERING SYSTEM

The course numbers appearing in the catalog are part of a statewide system of prefixes and numbers developed for use by all public postsecondary and participating private institutions in Florida. One of the major purposes of this system is to make transferring easier by identifying courses which are equivalent, no matter where they are taught in the state. All courses designated as equivalent will carry the same prefix and last three digits.

The classifying and numbering of courses is done by faculty in each academic discipline. Their work was reviewed by faculty members in all Florida's postsecondary institutions who make suggestions and criticisms to be incorporated into the system.

The course numbering system is, by law, descriptive and not prescriptive. It in no way limits or controls what courses may be offered or how they are taught. It does not affect course titles or descriptions at individual schools. It seeks only to describe what is being offered in postsecondary education in Florida in a manner that is intelligible and useful to students, faculty, and other interested users of the system.

The course numbering system was developed so that equivalent courses could be accepted for transfer without misunderstanding. Each public institution is to accept for transfer credit any course which carries the same prefix and last three digits as a course at the receiving institution. For example, if a student has taken SYG-000 at a community college, he/she cannot be required to repeat SYG-000 at a community college to which he/she transfers. Further, credit for any course or its equivalent, as judged by the appropriate faculty task force and published in the course numbering system, which can be used by a native student to satisfy degree requirements at a public institution, can also be used for that purpose by a transfer student regardless of where the credit was earned.

It should be noted that a receiving institution is not precluded from using **nonequivalent** courses for satisfying certain requirements.

GENERAL RULE FOR COURSE EQUIVALENCIES

All undergraduate courses bearing the same alpha prefix and last three numbers (and alpha suffix, if present) have been agreed upon by a faculty committee to be equivalent. For example, an introductory course in sociology is offered in over 36 postsecondary institutions in Florida. Since these courses are considered to be equivalent, each will carry the designator SYG-000.

FIRST DIGIT

The first digit of the course number is assigned by the institution, generally to indicate the year it is offered; i.e., "1" indicates freshman year, "2" indicates sophomore year. In the sociology example mentioned above, one school which offers the course in the freshman year will number it SYG-1000; a school offering the same course in the sophomore year will number it SYG-2000. The variance in the first numbers does **not** affect the equivalency. If the prefix and last three digits are the same, the courses are substantively equivalent.

TITLES

Each institution will retain its own title for each of its courses. The sociology courses mentioned are titled at different schools as "Introductory Sociology," "General Sociology," and "Principles of Sociology." The title does **not** affect the equivalency. The courses will carry the same prefix and last three digits; that is what identifies them as equivalent.



The OWCC SHOW CHOIR, shown during rehearsal, was one of the delightful surprises to emerge and develop in 1988 under the direction of Dr. Cliff Herron, Division Chair of the Fine and Performing Arts Division.

LAB INDICATORS

Some courses will carry an alpha suffix indicating a lab. The alpha suffixes "L" and "C" are used as follows to indicate laboratories:

"L" means either (a) the content of a course is entirely laboratory or (b) the laboratory component of a lecture-lab sequence in which the lab is offered at a different time/place from the lecture.

"C" means a combined lecture-lab course in which the lab is offered in conjunction with the lecture at the same time/same place.

Examples:

Marine Biology OCB-013 (lecture only)
OCB-013L (lab only)

Marine Biology (OCB-013C (lecture & lab combined)
with lab

Therefore, OCB-013C is equivalent to OCB-013 plus OCB-013L.

EQUIVALENCY OF SEQUENCES

In certain cases, sequences of courses in a given discipline are equivalent rather than the individual courses which make up these sequences. (For example, CHM-045 plus CHM-46). In several institutions, however, upon completion of the full sequence at any of the several institutions, students have completed substantively equivalent content. These sequences are clearly identified in the Course Equivalency Profiles.

EXPLANATION OF PREFIXES AND NUMBERS

Prefixes and numbers in the course numbering system are not chosen at random; they are designed to describe course content in an organized fashion within a classification system developed for each subject matter area.

Generally, each of the major classifications in a discipline is represented by a three-alpha prefix. In some cases, one three-alpha prefix has been sufficient for the entire discipline. A discipline may use as many prefixes as necessary to accommodate its major classifications. The logic of the system allows it to be infinitely expandable with minimal disruption to existing numbers.

History, for example, has seven prefixes. AFH, African History; AMH, American History; ASH, Asian History; EUHM European History; HIS, History-General; LAH, Latin American History; and WOH, World History. All history courses in the state will carry one of these prefixes. A more specific example is AMH 3421.



BELL RETURNS HOME. Dr. James Richburg, President, returns the college bell to the First Methodist Church, Niceville, from where it came more than 20 years ago. The original church burned and was reconstructed without a belfry so when the college was being formed, they donated the bell to the college.

AMH 3421 EARLY FLORIDA HISTORY

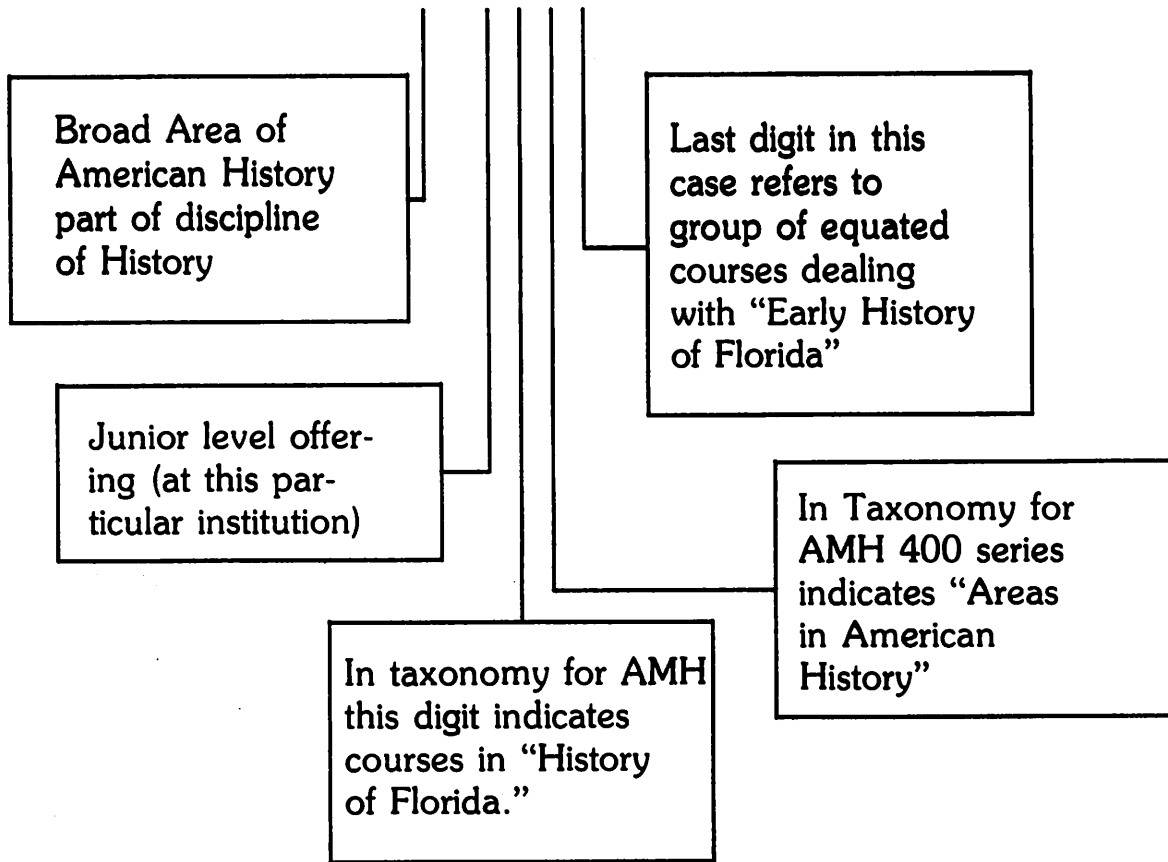

A complete inventory of taxonomy listings, equivalent and unique courses, has been made available to each academic department of every institution in the state. Students, through their local advisors, should use this information in designing programs which will transfer smoothly.

EXCEPTIONS TO THE RULE FOR EQUIVALENCIES

The following are exceptions to the general rule for course equivalencies:

- A. All numbers which have a second digit of 9 (ex. ART 2905) are "place keeper" numbers for courses which are classified as directed independent study, thesis hours, etc. Courses with -900 numbers must be evaluated individually and are not automatically transferable.
- B. All internships, practicums, clinical experiences and study abroad courses, whatever numbers they carry, are not automatically transferable.
- C. Performance or studio courses in art, dance, theatre, and music are not automatically transferable but must be evaluated individually.

AUTHORITY FOR ACCEPTANCE OF EQUIVALENT COURSES

Authority for acceptance of equivalent courses in State Board of Education Rule 6A-10.024(14) which states:

(14) When a student transfers among postsecondary area vocational-technical centers, community colleges, and universities, the receiving institution shall award credit for courses satisfactorily completed at the previous institutions when the courses are judged by the appropriate common course designation and number system faculty task forces to be equivalent to courses offered at the receiving institution and are entered in the course numbering system. Credit so awarded can be used by transfer students to satisfy in these institutions on the same basis as native students.

COURSE DISCIPLINE INDEX

(Discipline Index)

The courses which are offered by Okaloosa-Walton Community College are listed in the pages which follow in alphabetical and numerical order. See listing of course descriptions below.

Since various courses are dependent upon mastery of certain competencies, or prerequisites, admission to any course in subject to approval by the respective department chair.

Accounting (ACG, APA)	79-81	History (AMH)	80
Air Conditioning and Refrigeration (ACR)	79	Home Economics (FAD, HHD, HME, HOE, HUS)	94, 98, 99, 100
Art (ARH, ART)	81-82	Hotel Management (HFT)	98
Auto Mechanics (AER)	79-80	Human Growth and Development (DEP)	91
Aviation (AMT)	80	Humanities (ARH, HUM, REL)	81-82, 99, 109
Banking (BAN)	82	Journalism (JOU)	100
Biology (APB, BSC, MCB, OCE, PCB)	81, 83, 102, 105, 106	Law Enforcement (CCJ, CJD, CJT)	83-84, 87-88, 89-90
Botany (BOT)	83	Literature (ENG, LIT, ENL)	92, 100-102
Business (GEB)	96	Management (MAN)	101-102
Business Law (BUL)	83	Marketing (MAR, MKA)	102-103
Chemistry (CHM)	87	Math (MAC, MAE, MAP, MAS, MAT, MGF, MTB)	101, 102, 103
Child Development (CHD)	86-87	Meteorology (MET)	102
Clothing Construction (CTE)	90-91	Music (MUE, MUH, MUT, MUN, MVB, MVJ, MVK, MVP, MVS, MVW)	103, 104, 105
College Preparatory (ENC, MAT, REA)	92, 102, 108	Nutrition (HUN)	99
COMPASS (SLS)	109	Oceanography (OCE)	105
Computer Programming (CGS, CIS, COP, EME)	85, 86, 87, 90, 92	Paralegal (LEA)	100, 107
Construction Estimating (BCN)	82-83	Philosophy (PHI)	107
Consumer Education (COA)	90	Photography (PGY)	107
Continuing Education Units (Non-College-Credit Courses)	111-116	Physical Education (DAA, HLP, LEI, PEL, PEM, PEN, PET)	91, 99, 100, 106, 107
Creative Writing (CRW)	90	Physical Science (GLY, PSC)	97, 108
Criminal Justice (CCJ, CJD, CJT)	83, 84, 87-90	Physics (PHY)	107
Data Processing (CIS, COP, CRM)	82, 90	Political Science (POT)	108
Drafting and Design (ARC, ETD)	81, 93-94	Postal (MNA)	103
Economics (ECO)	91	Psychology (CLP, EEX, PSY)	90, 91, 108
Education (EPP)	93	Reading (REA)	108-109
Electronics (CET, EET, EST, ETG)	84-85, 91, 93, 94	Real Estate (REE)	109
Emergency Medical Technology (EMS)	92	Secretarial (OST)	105-106
Engineering Graphics (EGN)	91-92	Sociology (SYG)	110
English (ENC, LIN, LIS)	92, 100	Spanish (SPN, SPW)	109, 110
Fire Science (FFP)	94-95	Speech (SPC)	109
First Aid (HSC)	99	Statistics (STA)	110
Foods (FSS)	96	Survey (SUR)	110
French (FRE, FRW)	95, 96	Tax (TAX)	110
General Office Practices (OST)	105-106	Theatre (THE, TTP)	110
Geology (GLY)	97	Welding (PMT)	108
German (GER, GEW)	96-97	Word Processing (OST)	105-106
Government (POS)	108	World Civilization (INR, WOH)	100, 110
Graphics/Printing (GRA)	97-98	Zoology (ZOO)	110

COURSE DESCRIPTIONS

College Credit Courses: pp. 79-110

Noncredit Courses: pp. 111-116

ACG 2001

Accounting I, 3 semester hours, 45 lect. (Fall, Spring, Summer)

Principles of sole proprietorship. Use of journals, ledgers, trial balance, preparation of work sheets, balance sheets profit and loss statements, controlling accounts and subsidiary ledgers. Voucher systems, partnerships, corporation accounting, practice sets and problems required.

ACG 2011

Accounting II, 3 semester hours, 45 lect. (Fall, Spring, Summer)

Partnership formation and liquidation corporate stock and capital equity transactions, financing with long-term liabilities, branch and departmentalization, job order and process costing, budgetary control and standard costing and differential analysis, cost volume profit analysis and quantitative techniques, funds flow and financial position statements, consolidation; pooling and purchasing, and analyzing interpreting statements. Prerequisites: Accounting I.

ACR 1000*

Principles of Air Conditioning, 6 semester hours, 75 lec., 105 lab. (Offered as needed)

Beginning course in air conditioning and refrigeration with emphasis on basic fundamentals, safety, measuring tools, hand and power tools, soldering and brazing, blueprints, and basic mathematics.

ACR 1300*

Electrical Theory for Air Conditioning, 6 semester hours, 75 lec., 105 lab. (Offered as needed)

A study of alternating current, electrical theories and practices as they apply to air conditioning, study of Ohm's law, basic and advanced circuitry, switches and controls.

ACR 2060*

Air Conditioning, Heating and Refrigeration, 6 semester hours, 75 lec., 105 lab. (Offered as needed)

A continuation of air conditioning and heating practices with special emphasis on heat/load calculations, duct sizing, and psychrometric properties of air.

ACR 2307*

Environmental Control Systems for Buildings, 3 semester hours, 15 lec., 60 lab. (Offered as needed)

A course designed to further prepare a trained/experienced serviceman in the concept, theory, installation, operation and troubleshooting of pneumatic and electronic automatic control systems to regulate pressure, temperature, humidity, or rate and volume of flow to establish and maintain the indoor environment of a building or structure.

ACR 2600*

Principles of Gas, Electrical, and Solar Heating, 6 semester hours, 75 lec., 105 lab. (Offered as needed)

A course designed to prepare the student to acquire a working knowledge of gas, electrical, and solar heating systems. Pre-requisites: Principles of Air Conditioning and Electrical Theory for Air Conditioning.



ED LIVINGSTON and the Audio Visual staff.

ACR 2745*

Commercial Refrigeration and Air Conditioning, 6 semester hours, 75 lec., 105 lab. (Offered as needed)

A course designed to prepare the student to become familiar with commercial refrigeration and air conditioning systems, to properly size, install and/or service these systems and components. Prerequisites: Principles of A/C and Electrical Theory for A/C.

AER 1120*

Auto Suspension, Steering & Brakes, 6 semester hours, 30 lec., 150 lab. (Offered as needed)

A course in the fundamentals of diagnosing and repairing automotive malfunctions in the area of suspension, steering, and brakes. Includes lecture, demonstration, practical application activities and performance tests.

AER 1142*

Fuel, Lube and Cooling Systems, 6 semester hours, 30 lec., 150 lab. (Offered as needed)

A course in the fundamentals of diagnosing and repairing automotive malfunctions in automotive fuel, lubrication, and cooling systems. Includes lectures, demonstrations, practice application activities, and performance testing.

AER 1777*

Diesel Repair I, 3 semester hours, 15 lec., 60 lab. (Offered as needed)

A course intended for students who wish to develop basic skills in the area of diesel repair. Includes use of shop tools and safety procedures; fundamentals of diesels; diesel components and subsystems; operation, testing, maintenance, and service procedures.

AER 1779*

Diesel Repair II, 3 semester hours, 15 lec., 60 lab. (Offered as needed)

An advanced course in diesel repair involving diagnosis and repair of major diesel systems, use of specialized tools, use of advanced diagnostic equipment and techniques, and examination of parts for functionality and wear. Prerequisites: Diesel Repair I.

*Occupational course that may not be applied toward the A.A. Degree.

AER 2103***Automotive Electrical Systems, 6 semester hours, 30 lec., 150 lab. (Offered as needed)**

A course in the fundamentals of diagnosing and repairing malfunctions to automotive electrical systems. Includes lecture, demonstration, practical application activities, and performance testing.

AER 2112***Automotive Engines, 6 semester hours, 30 lec., 150 lab. (Offered as needed)**

A course in the fundamentals of diagnostics and repairing automotive malfunctions in the area of automotive engines. Includes lecture, demonstrations, practical application activities, and performance testing.

AER 2112A***Automotive Engines, 2 semester hours, 15 lec., 45 lab. (Offered as needed)**

This is the first in a series of three courses that will cover the fundamentals of diagnostics and automotive engine malfunctions. Includes lecture, demonstrations, practical application activities, and performance testing.

AER 2112B***Automotive Engines II, 2 semester hours, 15 lec., 45 lab. (Offered as needed)**

This is the second in a series of three courses that will cover the fundamentals of diagnostics and repairing automotive engine malfunctions. Includes lecture, demonstrations, practical application activities, and performance testing.

AER 2112C***Automotive Engines III, 2 semester hours, 15 lec., 45 lab. (Offered as needed)**

This is the third in a series of three courses that will cover the fundamentals of diagnostics and repairing automotive engine malfunctions. Includes lecture, demonstrations, practical application activities, and performance testing.

AER 2131***Transmission, 6 semester hours, 30 lec., 150 lab. (Offered as needed)**

Study and practical experience covering the clutch, standard transmission, automatic transmission, drive line, and differential.

AER 2171***Automotive Air Conditioning, 6 semester hours, 75 lec., 105 lab. (Offered as needed)**

A course designed to prepare a student to diagnose, service and repair automotive air conditioning systems.

AMH 1041**American Civilization, 3 semester hours, 45 lec. (Offered as needed)**

Unified history of social and intellectual issues. A study of major American concerns and issues, the proposals, their formative ideas, the resolution attained in an emerging pattern of American character and heritage.

AMH 2010**American History I, 3 semester hours, 45 lec. (Fall, Spring, Summer)**

American History to 1865; describes the social, political, and economic development of the American people against the geographical background of the New World. Particular emphasis on American intellectual and political thought leading to the emergence of basic American character, ideas and attitudes.

AMH 2020**American History II, 3 semester hours, 45 lec. (Fall, Spring, Summer)**

American History from 1865, concentrating on industrial growth, the rise of corporate business, big labor, and government organization. Modification of basic American character and ideas as a continual historical process.

AMT 1000***Aviation General, 4 semester hours, 60 lec. (Offered as needed)**

A course designed to prepare beginning students for careers in aviation mechanics, and/or help elective students broaden their knowledge and skills in this area. Covers all of the topics dealt with on the Aviation General portion of the FAA licensing exam.

AMT 1140***Aircraft Welding, 3 semester hours, 15 lec., 45 lab. (Offered as needed)**

Shop safety precautions and procedures; practical and theoretical training in the use of oxyacetylene, arc, and Tig welding, in general aviation; training in the recognition of various materials for welding and in the selection of the proper welding materials and equipment for use in general aviation.

AMT 1811***Air Frame Mechanics I, 4 semester hours, 60 lec. (Offered as needed)**

A course to prepare aircraft frame mechanics for the air-frame portion of the FAA licensing examination. Covers such topics as: fabrics, finishes, wood members, and sheetmetal. F.A.R. 65.77 must be complied with before student will be permitted to take FAA examination. Prerequisite: Aviation General

AMT 1812***Air Frame Mechanics II, 4 semester hours, 60 lec. (Offered as needed)**

A course to prepare aircraft frame mechanics for the air-frame portion of the FAA licensing examination. Covers such topics as: hydraulic systems for brakes, rigging for mechanical controls, electrical systems, weights and balance. F.A.R. 65.77 must be complied with before students will be permitted to take FAA examination. Prerequisite: Aviation General

AMT 1821***Air Power Plant Mechanics I, 4 semester hours, 60 lec. (Offered as needed)**

A course to prepare aircraft power mechanics for the power plant portion of the FAA licensing examination. Covers such topics as: fuel systems, electrical systems, and engine repair/overhaul. F.A.R. 65.77 must be complied with before student will be permitted to take FAA examination. Prerequisite: Aviation General

AMT 1822***Air Power Plant Mechanics II, 4 semester hours, 60 lec. (Offered as needed)**

A course to prepare aircraft power mechanics for the power plant portion of the FAA licensing examination. Covers such topics as: oil pressure, weights and balances, propellers, and a continuation of engine repair/overhaul. F.A.R. 65.77 must be complied with before student will be permitted to take FAA examination. Prerequisite: Aviation General

*Occupational course that may not be applied toward the A.A. Degree.

APA 1003**Accounting Fundamentals I, 3 credits, 45 lecture hours (Offered as needed)**

Fundamentals of Accounting I will introduce the student who has no accounting background to accounting for assets, liabilities, and owner's equity of a sole proprietorship. The student will review documents, record transactions in journals, post to ledgers, prepare work sheets, trial balances and financial statements, including: balance sheets, income statements and statement of owner's equity, to complete the accounting cycle. This course will not fulfill the *Principles of Accounting* requirements for upper division transfer programs. This course will help students prepare for the satisfactory completion of ACG 2001.

APA 1004**Accounting Fundamentals II, 3 credits, 45 lecture hours (Offered as needed)**

Fundamentals of Accounting II will expand the knowledge the student gained in Fundamentals of Accounting. The student will be introduced to the protection of and accounting for assets and liabilities in the merchandising operation. The student will expand his knowledge of financial statement and accounting procedures. The scope of the student will be broadened as he learns accounting for specific types of assets including accounts receivable and bad debts. The student will work with accounting for payroll and appropriate withholding and payroll taxes. Some problems will be worked on the computer so that the student will view the computer as an efficient tool in solving accounting problems and making the bookkeeping tasks more efficient. This course will not fulfill the *Principles of Accounting* requirements for upper division transfer programs. This course will help students prepare for the satisfactory completion of ACG 2001.

APB 1150**General Biology, 4 semester hours, 60 lec. (Fall, Spring, Summer)**

The principles of biology are included. Human Biology is emphasized. Man's effect on the environment is considered wherever appropriate. (NO LABORATORY — Not for majors in Biology).

APB 1150C**Biology I, 3 semester hours, 30 lec., 30 lab. (Fall, Spring, Summer)**

The nature of living organisms and of life, contemporary information concerning the basic biological concepts. A first-hand experience with the scientific method of study and an appreciation of man's understanding of his environment. (For non-science majors).

APB 1151C**Biology II, 3 semester hours, 30 lec., 30 lab. (Fall, Spring, Summer)**

The nature of living organisms and of life, contemporary information concerning the basic biological concepts and an appreciation of man's understanding of his environment. A study of human inheritance, anatomy, and physiology will be included. Prerequisite: Biology I is recommended.

APB 1200C**Anatomy & Physiology I, 3 semester hours, 30 lec., 30 lab. (Offered as needed)**

A study of the human organism to include cells, tissues, skeleton, muscular system, nervous system and gastrointestinal system.

APB 1201C**Anatomy & Physiology II, 3 semester hours, 30 lec., 30 lab. (Offered as needed)**

A study of the human organism to include the cardiovascular system, the fluid electrolyte balance, and the respiratory, excretory, endocrine and reproductive systems. Prerequisite: Anatomy & Physiology I.

APB 1231C**Microbiology, Allied Health, 4 semester hours, 45 lec., 30 lab. (Offered as needed)**

This course is designed for students entering programs in the numerous health fields, but primarily for pre-nursing students. The material presented covers the fundamentals of microbiology needed to understand the biology of infectious diseases and the agents that cause them. Not accepted as satisfying requirements for majors in biology, pre-med, pre-vet, and pre-dentistry.

ARC 2121C**Architectural Drafting, 3 semester hours, 15 lec., 60 lab. (Offered as needed)**

Architectural design and development of residential and light commercial buildings to include: development and construction of good architectural freehand lettering, VA and FHA approved residential house plans, "Good Sense" house plans as defined in the Arkansas Plan, and heat loss/heat gain calculations. Prerequisite: EGN 1120C or ETD 1111 or permission.

ARC 2303***Electrical Controls for Air Conditioning and Refrigeration, 6 semester hours, 75 lec., 105 lab. (Offered as needed)**

A course designed to prepare the student to diagnose and correct malfunctioning which may occur in air conditioning and refrigeration units. Prerequisite: Electrical Theory for Air Conditioning.

ARH 1000**Humanities Art, 3 semester hours, 45 lec. (Offered as needed)**

Basic concepts of art, including formal analysis and the sociology and psychology of style. Does not fulfill Art History requirement for art majors.

ARH 2050**Art History: Prehistoric-Renaissance, 3 semester hours, 45 lec. (Fall, or as needed)**

A survey of significant contributions in art, architecture and the crafts from prehistoric times through the Renaissance period.



CONGRESSIONAL REPRESENTATIVE Earl Hutto receives the college's appreciation from Dr. James R. Richburg, OWCC President.

*Occupational course that may not be applied toward the A.A. Degree.

ARH 2051**Art History: Renaissance-20th Century, 3 semester hours, 45 lec. (Spring, or as needed)**

A survey of significant contributions in art, architecture and the crafts from the Renaissance period to recent Twentieth Century works.

ART 1110C**Pottery I, 3 semester hours, 15 lec., 60 lab. (Offered as needed)**

The students shall be exposed to the production of pottery utilizing all known hand building techniques. Also includes introduction to potter's wheel and basic wheel fundamentals. First half of course is hand building, second half is devoted to development of skills on the potter's wheel. Students also learn how to glaze pottery and make glass.

ART 1111C**Pottery II, 3 semester hours, 15 lec., 60 lab. (Offered as needed)**

Continues hand building of Pottery I, but major emphasis is placed upon development skills utilizing the potter's wheel. Additional glazing experimentation is also emphasized. Prerequisite: Pottery I.

ART 1201C**Design I, 3 semester hours, 15 lec., 60 lab. (Offered as needed)**

Principles of visual organization. Deals with line, space, form and color in two-dimensional composition.

ART 1202C**Design II, 3 semester hours, 15 lec., 60 lab. (Offered as needed)**

Extension and development of the elements of design in three dimensional projects.

ART 1300C**Drawing I, 3 semester hours, 15 lec., 60 lab. (Offered as needed)**

Problems in drawing techniques and media.

ART 1301C**Drawing II, 3 semester hours, 15 lec., 60 lab. (Offered as needed)**

Problems in drawing and composition. Prerequisite: Drawing I or equivalent.

ART 1701C**Sculpture I, 3 semester hours, 15 lec., 60 lab. (Offered as needed)**

An introductory course in the techniques and aesthetic considerations of creating sculptural forms. Includes a wide range of possible materials and expressions, those used in the past and those being used currently, in both the reductive and additive methods. Students will be expected to solve problems in several different media that best expresses their particular sensibilities.

ART 1702C**Sculpture II, 3 semester hours, 15 lec., 60 lab. (Offered as needed)**

A course in the creation of ceramic sculpture forms. Includes a wide range of possibilities in the use of ceramic materials to produce nonutilitarian forms. (It is expected that the student have a basic knowledge of clay and glazes as a prerequisite.)

ART 1905**Independent Study – Art, 1 credit hour (Offered as needed)**

A defined independent study which is pursued under supervision of a faculty directing teacher and recorded through departmental procedures. Designed to permit a student to pursue non-scheduled academic and laboratory work which may be of a specialized or advanced nature and not available through classes or courses available on a college schedule. Departmental approval required.

ART 2510C**Painting I, 3 semester hours, 15 lec., 60 lab. (Offered as needed)**

Problems of constructing a composition in color. The academic methods of painting and student experimentation.

ART 2520C**Painting II, 3 semester hours, 15 lec., 60 lab (Offered as needed)**

Technique is stressed as an end result of approach to subject matter, development of abstraction through the use of theory. Prerequisite: Painting I or equivalent.

BAN 1004**Principles of Bank Operations, 3 semester hours, 45 lec. (Offered as needed)**

This course represents the fundamentals of bank functions in a descriptive fashion so that the beginning banker may acquire a broad (and operational) perspective. The descriptive orientation is intentional.

BAN 2210**Analyzing Financial Statements, 3 semester hours, 45 lec. (Offered as needed)**

This course presents the fundamentals of financial statement analysis. It is intended to train the student in the use of tools and techniques necessary for the evaluation of the financial condition and operating performance of a business enterprise. Prerequisite: ACG 2001.

BAN 2501**Money and Banking, 3 semester hours, 45 lec. (Offered as needed)**

This course stresses the practical aspects of money and banking and emphasizes the basic inventory theory needed by the banking student to apply knowledge acquired on the job. Historical treatment is kept to a minimum. Emphasis is also placed on such problems as economic stabilization, types of spending, the role of gold, limitations of central bank control, government fiscal policy, balance of payments, and foreign exchange. Prerequisite: ECO 2013/2023

BAN 2900**Directed Study-Banking, 1 semester hour, 30 lab. (Offered as needed)**

A directed study designed to enable the student interested in banking to pursue an in-depth study of a specialized area of banking.

BCN 1230***Building Construction: Materials and Processes, 3 semester hours, 45 lec. (Offered as needed)**

Course designed to introduce the student to terminology, methods, procedures, materials, and processes used in the construction industry.

BCN 1272***Blueprint Reading for Commercial Construction, 3 semester hours, 45 lec. (Offered as needed)**

A course to familiarize non-drafting students with techniques of blueprint reading and the fundamentals of construction methods that make blueprint reading meaningful.

BCN 1520***Electrical Systems in Construction, 3 credits, 45 hours.**

A course to familiarize students with electrical terminology, practices, methods, code requirements and safety and health in construction.

*Occupational course that may not be applied toward the A.A. Degree.

BCN 1567***Plumbing and Gas Construction Practices, 3 credits, 45 hours. (Offered as needed)**

A course to familiarize students with Plumbing and Gas code requirements, terminology, methods, practices, processes and safety and health used in building construction.

BCN 1708***Construction Documentation, 3 semester hours, 45 lec. (Offered as needed)**

A course to familiarize a student with documents used in the Construction Industry to advertise for bids, contracts, change orders, extras, specification, insurance and bid bonds.

BCN 2475***Structural Systems in Construction, 3 credits, 45 hours. (Offered as needed)**

A course to familiarize students with Structural terminology, practices, methods, code requirements and safety and health criteria in construction.

BCN 2560***Mechanical Systems in Construction, 3 credits, 45 hours. (Offered as needed)**

A course to familiarize students with mechanical trades terminology, methods, practices, code requirements processes, and safety and health criteria in mechanical construction.

BCN 2610***Construction Estimating, 3 credits, 45 hours. (Offered as needed)**

A course in estimating as it relates to the construction industry. Material covered includes: references, estimating methods, take-off organization and presentation, material take-off and cost estimating in heavy construction.

BCN 2721***Construction Management Planning, 3 credit hours, 45 lec. (Offered as needed)**

The course covers the development and organization of projects, preconstruction site investigation, planning, scheduling, estimating. The course will also include control of costs, operations and resources together with cost engineering, procurement, value engineering, quality assurance, safety and health in construction.

BOT 1010C**Botany, 4 semester hours, 45 lec., 45 lab. (Fall, Spring, Summer)**

A course designed to introduce the student to the biological principles of the plant kingdom with emphasis on the flowering plants.

BSC 1905**Independent Study-Biology, 1 semester hour (Fall, Spring, Summer)**

A course designed to (1) allow a student to complete part of a course taken elsewhere and thereby complete general education requirements, (2) to go deeper into special areas of interest. Permission of department chair.

BSC 2905**Tutorial Biology, 1 semester hour, 45 lab. (Fall, Spring, Summer)**

An experience in individual depth study in which one student prepares for and engages in tutoring another for two class periods a week.

BSC 2946**Directed Work Study-Biology, 1 semester hour, 45 lab. (Fall, Spring, Summer)**

Directed experience in instructional, laboratory and/or materials assistance in a designated biology area. Entry by permission of department chair only.



MEMBERS of the Science department.

BUL 2111**Business Law I, 3 semester hours, 45 lec. (Fall, Spring, Summer)**

Introductory course in business law with objective of presenting the law underlying business transactions. Course includes the study of the Law of Contracts, the Law of Bailments, and the law of sales based on the UNIFORM COMMERCIAL CODE. Recommended for all business students.

BUL 2112**Business Law II, 3 semester hours, 45 lec. (Fall, Spring, Summer)**

Course context explores laws relative to Negotiable Instruments, Agency, Partnerships, (includes study of Uniform Partnership Act), Corporation Law, Creditors Rights, Consumer Protection and Insurance. Based on Uniform Commercial Code.

CCJ 1000**Introduction to Criminology, 3 semester hours, 45 lec. (Spring)**

A study of the nature and causes of crime and delinquency; the development of delinquent and criminal behavior; specific behavioral problems of addicts, compulsive and habitual offenders and juvenile offenders.

CCJ 1020**Introduction to Criminal Justice, 3 semester hours, 45 lec. (Fall, Spring, Summer)**

An introduction to the philosophical and historical background of law enforcement and the administration of criminal justice. Organization and jurisdiction of local, state, and federal law enforcement agencies. Court and Criminal procedures. Career opportunities in Criminal Justice field.

CCJ 1121**Crime Prevention, 3 semester hours, 45 lec. (Offered as needed)**

A course in crime prevention as it exists today in America. Study includes residential, personal and commercial crime prevention and it includes crime prevention resources, crime analysis and current legal implications. Designed primarily for in-service law enforcement officers but will not be limited to such personnel.

*Occupational course that may not be applied toward the A.A. Degree.

CCJ 1192**Crisis Intervention, 3 semester hours, 45 lec. (Offered as needed)**

A study of the nature and causes of human stress in crisis situations involving criminal justice practitioners to include law enforcement, judicial and correctional personnel: definitions, recognition and assessment, general calming techniques, intervention: safety, abnormal behavior and suicide, role playing, causes of psychological and physiological stress agents inherent in the duties of criminal justice practitioners and countermeasures to anxiety and stress reduction. Permission of the instructor needed.

CCJ 1210**Criminal Law, 3 semester hours, 45 lec. (Fall, Spring, Summer)**

Fundamentals of Criminal Law to include historical background and development, jurisdiction, the criminal act and responsibility. Classification and analysis of Florida Statutes.

CCJ 1230**Criminal Procedure, 3 semester hours, 45 lec. (Fall, Spring, Summer)**

Fundamentals of constitutional, criminal and civil law. Principles, duties and mechanics of criminal procedures in Florida as applied to arrest, search, seizure, and court processing. A functional analysis of the rules of evidence in court procedures.

CCJ 1310***Discipline and Special Confinement Techniques, 3 semester hours, 45 lec. (Offered as needed)**

The student is introduced to the essentials of discipline and special confinement techniques necessary for the corrections profession. The topics to be introduced include physical operation, physical force, recognizing abnormal behavior, verbal and nonverbal communications.

CCJ 1400**Police Organization and Administration, 3 semester hours, 45 lec. (Offered as needed)**

Principles of organization and administration in law enforcement; fundamentals of police planning: budget analysis, recruitment, training, and assignments; disciplinary problems and methods of control; cooperation with other agencies; public relations; records and inspection.

CCJ 1500**Juvenile Delinquency, 3 semester hours, 45 lec. (Offered as needed)**

A study of the nature and cause of juvenile delinquency, the development of the delinquent and criminal behavior, specific criminal justice subsystem (law enforcement, judicial, corrections) problems dealing with juvenile delinquents from initial contact through final disposition and treatment.

CCJ 1650**Introduction to Narcotics Investigation, 3 semester hours, 45 lec. (Offered as needed)**

This introductory course in narcotics investigation and identification is designed to provide the student with an overview of narcotics and the role of the investigative agencies, drug traffic flow patterns, major classes of drugs and the drug profit traffic. Instruction will cover techniques of investigative observation, patrol and case development, physical identification of drugs, symptoms of abuse, methods of abuse and appropriate Florida Statutes. This is also a Criminal Justice Standards and Training Commission advanced course.

CCJ 1935**Criminal Justice Seminar, 3 semester hours, 45 lec. (Offered as needed)**

Exploration, development and discussion of contemporary problems in the Criminal Justice System.

CCJ 1941***Internship – Criminal Justice, 3 semester hours, 225 hrs. (Offered as needed)**

On-the-job training in the Associate of Science/Applied Science Option program in which the student is enrolled. The student is under the supervision at work of a qualified supervisor. The supervisor will rate the student's performance, knowledge, comprehension, dependability, initiative, cooperativeness, and total performance. A project paper or approved project will be submitted by the student three weeks prior to the close of the semester. May be repeated four times for a total of 12 semester hours. Prerequisite: Must be enrolled in at least one other course in the respective degree program.

CCJ 2070**Computer Applications in Criminal Justice, 3 semester hours, 45 lec. (Offered as needed)**

Computer Applications in Criminal Justice introduces the participant to the use of the computer in Criminal Justice applications. The participant will be introduced to pre-packaged software and the process used to modify the package to criminal justice usage. This will include an electronic filing system designed to store, review and update data which can be manipulated into printed reports for daily and periodic usage.

CCJ 2300**Introduction to Corrections, 3 semester hours, 45 lec. (Fall)**

Theories of punishment and incarceration; the organization of correction programs and institutions, principles of probation and parole, role of parole and probation officers, legal implications; problems of rehabilitation.

CCJ 2905**Independent Study – Criminal Justice, 1 semester hour, 45 lab. (Fall, Spring)**

Directed study and individual projects to meet the student's interests in a specialized area of Criminal Justice for which present course availability is limited. Prerequisite: Permission of the instructor.

CET 1123C**Microprocessors, 5 semester hours, 30 lec./135 lab. (Offered as needed)**

The philosophy, evolution, architecture, instruction set, and programming of a more advanced microprocessor is studied. Included will be a minimum of ten hands-on experiences. Prerequisite: CET 2113C or permission of department chair.

CET 2112C**Digital Technology I, 5 semester hours, 30 lec./135 lab. (Offered as needed)**

Studies include coding, decoding, logic gates, DeMorgan's Theorem, boolean algebra and Karnaugh Map simplification, logic families, flip-flops, counters, shift registers, ALU multiplexers, demultiplexers, PLA, A/D and D/A converters. Prerequisite: EET 1015C or permission of department chair.

CET 2113C**Digital Technology II, 5 semester hours, 30 lec./135 lab. (Offered as needed)**

This course covers the architecture, instruction set, and programming of a common microprocessor. Subjects covered will include programming, input/output, and troubleshooting. The student will use logic and signature analysis in order to find instructor inserted faults. Assembly language programming and writing of algorithms will be introduced. Prerequisite: CET 2112C or permission of department chair.

*Occupational course that may not be applied toward A.A. Degree.



SHAKESPEARE is brought to the second grade by Becky Sears using pictures of cats to represent the characters in a Midsummer Night's Dream. She is assisted by Margaret Crozier, head of the Communications Department.

CET 2152C*

Computer/Analysis & Troubleshooting, 5 semester hours, 30 lec./135 lab. (Offered as needed)

This course will expand on the knowledge gained in Digital Technology II. Three units of instruction covering troubleshooting, input/output, and memories will be covered. A more advanced level of digital system troubleshooting will be introduced. Prerequisite: CET 2113C or permission of department head.

CET 2311C*

Computer Assisted Circuit Analysis, 4 semester hours, 30 lec., 60 lab. (Offered as needed)

This course is designed to reinforce the student's knowledge of the laws, theorems, and concepts of electronics and their applications in network analysis. It also introduces BASIC language programming and the use of the computer in generating instantaneous, error free results. The time normally taken with laboratory work will be utilized in writing and testing BASIC language programs for circuit analysis. Prerequisite: Basic Electricity/Electronics I & II or permission of instructor.

CGS 1000

Introduction to Computer Programming, 3 semester hours, 45 lec., 45 lab. (Offered as needed)

An introduction to the BASIC (Beginner All Purpose Symbolic Instruction Code) programming language and flowcharting. Stresses the importance of logical and proper documentation of programs. Designed for students to use knowledge obtained as a tool in their chosen field. Prerequisite: CIS 1000

CGS 1060

Computer Literacy, 3 semester hours, 45 lec. (Offered as needed)

An overall view of computers and how they affect each person as well as society. Hands-on experience is provided. Recommended for non data processing majors.

CGS 1931A

Teaching Reading Using a Microcomputer, 3 semester hours, 45 lec. (Offered as needed)

This course presents the microcomputer as a tool for supporting and enhancing the Reading curriculum. Students will evaluate reading programs and learn to integrate them into the classroom environment. Prerequisite: EME 1920 or prior experience with microcomputers in education. Recommend having computer tools for the teacher.

CGS 1931B

Teaching Science Using the Microcomputer, 3 semester hours, 45 lec. (Offered as needed)

This course presents the microcomputer as a tool for supporting and enhancing the science curriculum. Students will use spreadsheets, databases, measuring devices, and other science programs. Prerequisite: EME 1920 or prior experience with microcomputers in education. Recommend having computer tools for the teacher.

CGS 1931D

Teaching Social Studies Using A Microcomputer, 3 semester hours, 45 lec. (Offered as needed)

This course presents the microcomputer as a tool for supporting and enhancing the social studies curriculum. Students will evaluate social studies programs and learn to integrate them into the classroom environment. Databases will be utilized in the collection and storage of research data. Prerequisite: EME 1920 or prior experience with microcomputers in education. Recommend having computer tools for the teacher.

CGS 1931E

Teaching Logo in the Classroom, 3 semester hours, 45 lec. (Offered as needed)

This course is to familiarize students with the Logo programming language and its use in the classroom. Students will learn to use Logo to integrate computers with the curriculum. Prerequisite: Some computer experience recommended.

CGS 1931F

Computer Tools for the Teacher, 3 semester hours, 45 lec. (Offered as needed)

This course is designed to introduce and familiarize students to microcomputer tools which will streamline classroom management. Students will be introduced to the word processor, database managers, spreadsheets, test makers, and graphics packages. Prerequisite: EME 1920 or prior experience with microcomputers in education.

CGS 1931G

Teaching Writing Using a Microcomputer, 3 semester hours, 45 lec. (Offered as needed)

This course is designed to teach students the writing process and use of a word processor in writing instruction. Students will evaluate and use other software for teaching writing. Prerequisite: EME 1920 or prior experience with microcomputers in education. Recommend having computer tools for the teacher.

CGS 1931I

Teaching Math Using a Microcomputer, 3 semester hours, 45 lec. (Offered as needed)

This course presents the microcomputer as a tool for supporting and enhancing the math curriculum. Students will evaluate math programs and learn to integrate them into the classroom environment. Databases will be utilized to store problem databanks for testing and practice worksheets. Prerequisite: EME 1920 or prior experience with microcomputers in education. Recommend having computer tools for the teacher.

CGS 2510

Introduction to Electronic Spreadsheets, 2 semester hours, 30 lec. (Offered as needed)

An introduction to the use of integrated software, such as Lotus 1-2-3, as a problem solving tool. The spreadsheet, database, and graphics features are examined and used in practical exercises.

CGS 2540

Introduction to dBase III, 2 semester hours, 30 lec. (Offered as needed)

An introduction to file creation, maintenance, and report generation using dBase III. Covers both interactive applications and programming with dBase III.

*Occupational course that may not be applied toward the A.A. Degree.

CGS 2560**MS-DOS/Microcomputer, 1 semester hour 15 lec.**

An introduction to the use of the microcomputer and the disk operating system (DOS).

CGS 2573**Introduction to Word Perfect, 2 semester hours, 30 lec. (Offered as needed)**

Introduction to Word Perfect software functions by providing basics of the software: Loading the Program, Entering and Editing Text, Formatting, Printing, Merge Printing, Desktop Publishing.

CGS 2574**Introduction to Word Star, 2 semester hours, 30 lec. (Offered as needed)**

Introduction to Word Star software by emphasizing the functions of the program: MENUS, COMMANDS/DISPLAY CHARACTERS/FLAG CHARACTERS, KEYBOARD OPERATIONS, FINDING WORDS AND CHECKING SPELLING, PRINTING, MERGE PRINTING.

CGS 1060**Computer Literacy, 3 semester hours, 45 lec. (Offered as needed)**

An overall view of computers and how they affect each person as well as society. Hands-on experience is provided. Recommended for non data processing majors.

CHD 1220**Child Growth and Development I, 3 semester hours, 45 lec. (Fall)**

Growth and development of the child from conception through age five, including the physical, social, emotional and mental development of the young child, influence of environment, principles and theories of development.

CHD 1230**Child Growth and Development II, 3 semester hours, 45 lec. (Fall)**

Study of the physical, emotional, social, and intellectual growth and development of the school age child (6 through 12 years) up to preadolescence. Includes dynamics of behavior, child guidance and needs of exceptional children.

CHD 1430**Observing and Recording Child Behavior, 3 semester hours, 30 lec., 45 lab. (Fall)**

Designed to increase objectivity and proficiency in observing and interpreting children's behavior; in addition, to increase awareness of normative patterns of children from birth through five years of age.

CHD 1941***Internship, Child Development, 3 semester hours, 90 lab. (Offered as needed)**

On-the-job training in Associate of Science degree, Associate degree/Applied Science Option, Certificate programs in which the student is enrolled. The student is under the supervision at work of a qualified supervisor appointed by the respective agency, who works with the OWCC instructor regarding student's OJT objectives based on student's goals and prior training. The supervisor will rate the student's performance, knowledge, comprehension, dependability, initiative, cooperativeness based on OJT performance. OWCC instructor will evaluate student OJT experience in consultation with agency supervisor regarding OJT performance and project paper on approved project submitted two weeks prior to close of semester. This course may be repeated four times for a total of 12 semester hours. Prerequisite: Must have completed a minimum of 9 hours credit in appropriate discipline.

CHD 2130***Orientation to CDA Credentialing, 1 semester hour, 15 lec., 5 lab (Offered as needed)**

A course including orientation to the Child Development Associate credentialing process; preassessment by means of written evaluation, skill test and observation of student's performance with young children; and development of student assessment plan.

CHD 2131***Portfolio Building I, 1 semester hour, 15 lec., 5 lab. (Offered as needed)**

An introductory course in portfolio building including requirements of a CDA portfolio and alternative formats. Focuses on developing autobiographical sketches and documenting competencies relating to setting up and maintaining a safe and healthy learning environment.

CHD 2132***Portfolio II, 1 semester hour, 15 lec., 5 lab (Offered as needed)**

A course focusing on portfolio building with emphasis on advanced physical and intellectual competency (CDA competency #2) and building a positive self concept and individual strength (CDA competency #3).

CHD 2133***Portfolio Building III, 1 semester hour, 15 lec., 5 lab. (Offered as needed)**

A course focusing on portfolio building with emphasis on organizing and sustaining positive functioning of children and adults in a group learning environment (CDA competency #4); bringing about optional coordination of home and center childrearing practices and expectations (CDA competency #5) and carrying out supplementary responsibilities related to the children's programs (CDA competency #6).

CHD 2322**Programs for Young Children, 3 semester hours, 45 lec. (Spring)**

Study of principles and practices of programs for young children; current research in early childhood education, role of the teacher, and selection and use of equipment and materials for groups of young children.

CHD 2332***Curriculum for Young Children II, 4 semester hours, 15 lec., 90 lab. (Spring and as needed)**

Study of and development of effective skills and techniques used in program planning and use of creative media for young children.

CHD 2334***Curriculum for Young Children III, 4 semester hours, 15 lec., 135 lab. (Spring and as needed)**

Study of the principles, methods, and materials used to assist young children acquire basic skills to use language effectively and competently; evaluation and development of appropriate teaching materials to use with young children.

CHD 2337***Curriculum for Young Children IV, 4 semester hours, 15 lec., 90 lab. (Offered as needed)**

Study of the basic concepts, methods, and materials of mathematics, science, and social studies appropriate to the education of young children; identification of the role of staff members in the center for the education of young children; and overview of parent education.

*Occupational course that may not be applied toward the A.A. Degree.

CHD 2432 Curriculum for Young Children I, 3 semester hours, 15 lec., 90 lab. (Fall, Summer)

Study of the techniques of using language arts, science, art, social studies, music, mathematics, and physical activities with young children. Participation in Child Development Education Center.

CHD 2433*

Child Development Seminar, 3 semester hours, 45 lec. (Spring and as needed)

Weekly seminar to critique performance and plan effective intern experience. Prerequisite: CHD 2332, 2334, or 2337 or permission of instructor.

CHM 1020

Chemical Science, 4 semester hours, 60 lec. (Fall, Spring, Summer)

Fundamental principles and theories of the dual nature of physical existence, matter and energy; atomic theory; periodicity of elements; dependence of properties on structure; kinetic molecular theory; the nature of chemical bonding; and the collision theory of reactions. Meets graduation requirements for programs other than science and mathematics.

CHM 1045C

College Chemistry I, 4 semester hours, 45 lec., 45 lab. (Fall, Spring, Summer)

Quantitative approach to modern theoretical and physical chemistry, with appropriate development of laboratory techniques. Logical treatment of experimental data leading to understanding of (1) particulate, electrical nature of matter and bonding, (2) periodicity of properties of the elements, and (3) relationships of properties to structure. For science majors, pre-medical, pre-engineering students and others who have acceptable backgrounds in chemistry and math.

CHM 1046C

College Chemistry II, 4 semester hours, 45 lec., 45 lab. (Fall, Spring, Summer)

Continuation of CHM 1045C: Solutions, chemical equilibrium and qualitative analysis. Electrochemistry, radiation chemistry and hydrocarbons.

CHM 2210C

Organic Chemistry I, 4 semester hours, 45 lec., 45 lab (Offered as needed)

Hydrocarbons, stereochemistry, molecular structure, and reaction mechanisms. Prerequisite: CHM 1045C and 1046C or permission of the instructor.

CHM 2211C

Organic Chemistry II, 4 semester hours, 45 lec., 45 lab (Offered as needed)

Functional groups, IR, NMR, and mass spectroscopy theory. Prerequisite: CHM 2210C

CIS 1000

Data Processing Concepts, 3 semester hours, 45 lec. (Fall, Spring, Summer)

A beginning course in data processing designed for both the data processing major as well as those students who need a general understanding of the modern computer. A broad overview of digital computers including history of computers, number systems, punched card processing, storage concepts, coding systems, and input/output systems.

CIS 1920

Programming Skills Workshop, 1 semester hour, 20 lec. (Offered as needed)

A workshop that involves applications in advanced programming (uses of BASIC and PASCAL) through graphics and telecommunication processes for the classroom teacher. Prerequisite: Computer Application Skills Workshop or prior experience with microcomputers in education.

CIS 1921

Education Software Workshop, 1 semester hour, 20 lec. (Offered as needed)

A workshop to assess software for computer assisted instruction and computer managed instruction applications and determining effective strategies of integrating software into school curriculum. Prerequisite: Programming Skills Workshop.

CJD 1121

Special Tactical Problems for Law Enforcement, 3 semester hours, 45 lec. (Offered as needed)

This course is a part of the Criminal Justice Standards and Training Commission Advanced Training Program. It is designed to prepare law enforcement officers for police operations which involve special tactical situations and will include; importance of physical well-being in the Criminal Justice setting, an overview of Florida local disaster procedures, civil disorder patterns, special task force unit operations, special crime areas and practical exercises.

CJD 1200

Law Officer Skills, 2 semester hours, 15 lec., 30 lab (Offered as needed)

A skills development course designed to upgrade the auxiliary and/or inservice police officer in the areas of driver improvement, arrest techniques, stress reduction, medical emergencies and use of firearms. A Florida Standards Salary incentive course.

CJD 1250*

Interviews and Interrogations, 3 semester hours, 45 lec. (Offered as needed)

An advanced course designed to cover the techniques, methods, principles, and issues of interviewing and interrogations. Course meets Florida Police Standards Salary Incentive Requirements.

CJD 1253

Defensive Tactics, 3 semester hours, 30 lec., 30 lab. (Offered as needed)

This course is designed to qualify students and especially in-service law enforcement and correctional officers in the art of defensive tactics and self-defense; to include the legal aspects of the use of force; pre-conditioning, defense and injury protection, defenses to unarmed attack, defenses against armed attacks, and the regulations, laws and techniques relating to the use of force. This is an advanced course under rules of the Florida Criminal Justice Standards and Training Commission.



THE PRESIDENT receives a framed copy of the House Bill that transferred land from the Air Force to be used for a new, permanent OWCC/UWF Fort Walton Beach Center. Presenting it is Randy Knepper, Administrative Assistant to Representative Earl Hutto. Knepper was guest speaker at the Second Annual Founders Day banquet held in the College Mall, January 16, 1989.

*Occupational course that may not be applied toward the A.A. Degree.

CJD 1420*
Correctional Law, 3 semester hours, 45 lec. (Offered as needed)

A course in practical law for correctional personnel. Study includes law regulating use of forces, civil rights of prisoners, constitutional law, legal service, disciplinary proceedings, parole, and current case law.

CJD 1460*
Correctional Operations, 3 semester hours, 45 lec. (Offered as needed)

Responsibilities, powers, and duties of the correctional officer; correctional administration; physical security; facility services; intake, classification and release procedures; special programs; human skills; understanding and responding to inmate behavior and correctional proficiency skills.

CJD 1461
Introduction to Basic Corrections, 3 semester hours, 45 lec. (Offered as needed)

This course is designed to introduce the participant to basic corrections law and its role within the criminal justice system, based on established standards of the Department of Law Enforcement and the Criminal Justice Standards and Training Commission. Prerequisites: Students must be sponsored by a state or local correctional agency and earn minimum entry level placement scores required for college level English communications courses.

CJD 1462*
Basic Correctional Techniques, 3 semester hours, 45 lec. (Offered as needed)

This course is designed to provide the participant with the various techniques used in a correctional facility when dealing with communication, emergency procedures and inmate control, based on established requirements of the Florida Department of Law Enforcement and Criminal Justice Standards and Training Commission.

CJD 1468*
Youthful Offenders, 3 semester hours, 45 lec.

A course designed to provide the student with an overview and awareness of Florida youthful offender programs to include; facilities and specialized programs, staff-inmate relations, one-way/two-way communications and effective communications and effective communications skills, positive characteristics for staff working with youthful offenders; the helping relationship inventory, local treatment programs, opportunities and alternatives, treatment problem solving and other techniques relating to youthful offenders.

CJD 1501*
Criminal Justice Instructor Techniques, 3 semester hours, 45 lec. (Offered as needed)

A basic course in instrumental principles designed to equip the law enforcement specialist with techniques of classroom and field training methods.

CJD 1602*
Drug Awareness, 3 credits, 45 lec. (Offered as needed)

This course is a part of the Criminal Justice Standards and Training Commission approved Advanced Training Program. It is designed to familiarize students with common drug abuse terms, classes of drugs, pharmacological information relating to commonly used and abused chemicals and their effects, an overview on use patterns and characteristics of drug abusers, how to troubleshoot and deal with problems that develop among abusers and effective presentation skills.

CJD 1610*
Criminal Investigative Techniques, 3 semester hours, 34 lec. (Offered as needed)

A course designed to provide the student with instruction in Florida investigative concepts and techniques, use of evidence and related matters.

CJD 1611*
Child Abuse and Neglect, 3 semester hours, 45 lec. (Offered as needed)

This course was designed to provide the student with an enhanced awareness of child abuse symptoms and patterns, including information and case studies on specific abuse and social problems.

CJD 1631*
Florida Police Operations and Leadership, 3 semester hours, 45 lec. (Offered as needed)

A course designed to provide the student with instruction in Florida patrol techniques, criminal investigations, civil and criminal liability matters, discretion/decision making and related matters.

CJD 1680*
Florida Criminal Law, 3 semester hours, 45 lec. (Offered as needed)

A course designed to provide the student with an overview of criminal law, laws of arrest, rules of evidence, etc. concerning Florida law.

CJD 2254*
First Responder for Law Enforcement, 3 semester hours, 45 lec. (Offered as needed)

This course is designed primarily to qualify in-service law enforcement and correctional officers in the area of first responder to medical emergencies to include: introduction to first responder training, overview of the human body, diagnostic signs of patient examination, airway care & pulmonary resuscitation, cardiopulmonary resuscitation, shock, bleeding, primary patient care and injuries.

CJD 2310*
Criminal Justice Supervision, 5 semester hours, 80 lec. (Offered as needed)

A career development course for full time police officers designed to train the line supervisor.

CJD 2320*
Criminal Justice Management, 5 credits, 80 lec. (Offered as needed)

An advanced course designed to train criminal justice supervisors in the techniques and procedures necessary for middle managers.

CJD 2461*
Advanced Correctional Operations, 3 semester hours, 45 lec. (Offered as needed)

An advanced course in correctional operations for in-service Florida Correctional Officers designed to increase skills in correctional agency organization and mission, records and reports, legal applications to correctional operations, correctional facility security, intake/classification/release procedures, fire safety and discipline procedures, introduction to supervision and release and bonding procedures. This is course number 59 in the series approved by the Florida Criminal Justice Standards and Training Commission Advanced Courses.

CJD 2467
Counseling and Communications Skills, 3 semester hours, 45 lec. (Offered as needed)

Designed to give the participant an understanding of the fundamentals of counseling and communication skills needed by state correctional officers.

*Occupational course that may not be applied toward the A.A. Degree.

CJD 2470***Emergency Preparedness for Correctional, 3 semester hours, 45 lec. (Offered as needed)**

This course is designed to qualify in-service correctional officers and correctional support personnel in the area of emergency preparedness, to include; emergency plans, specifics on disturbances and disorder planning, hostage plans and situations, factors affecting emergency planning and management and leadership.

CJD 2605**Traffic Homicide Investigation, 3 semester hours, 45 lec. (Offered as needed)**

Course content covers traffic homicide investigation skills to include reconstruction, meets Florida Justice Standards and training certification requirements for career development.

CJD 2626***Hostage Negotiations for Criminal Justice, 3 semester hours, 45 lec. (Offered as needed)**

This course is designed to qualify in-service law enforcement and correctional officers and support personnel in the area of hostage negotiations, to include; introduction to the problem, types of hostage negotiations principles, communications principles, intelligence gathering, abnormal behavior and participant performance exercises.

CJD 2632**Field Training Officer Techniques, 3 semester hours, 45 lec. (Offered as needed)**

Designed to introduce the criminal justice student (law enforcement and corrections) to all aspects of field training and evaluation programs to include adult learning and instruction, evaluation, role responsibilities and characteristics of the Field Training Officer (F.T.O.), communications techniques, counseling techniques, legal and ethical issues and human motivation. This is course number 51 in the series approved by the Florida Criminal Justice Standards and Training Commission Advanced Courses.

CJD 2670***Confidential Informants, 3 semester hours, 45 lec. (Offered as needed)**

This course is designed for in-service law enforcement, correctional officers and support personnel to qualify them in the area of development of confidential informants and other sources of information, to include; definition and management of an informant program, legal aspects of dealing with informants, and the development of other sources of investigative information.

CJD 2681***Court Case Preparation and Court Presentation, 3 semester hours, 45 lec. (Offered as needed)**

Fundamentals of criminal case preparation and court presentation for the law enforcement and/or correctional officer to include case files, pre-trial discovery, depositions, plea bargaining, court testimony, moot court, post adjudication responsibilities, case studies and a practical exercise. This is course number 20 in the series approved by the Florida Criminal Justice Standards and Training Commission Advanced courses.

CJD 2691***Stress Awareness and Resolution, 3 semester hours, 45 lec. (Offered as needed)**

A course designed to provide the student with an overview and awareness of stress and its resolution, to include: identification of various types of stress, the results of stress, psychological methods of controlling stress, case study analysis, and spouse awareness and involvement. This is course number 50 in the series approved by the Florida Criminal Justice Standards and Training Commission Advanced Courses.

CJT 1120**Crime Scene Procedures, 3 semester hours, 45 lec. (Offered as needed)**

Course emphasizes preliminary investigation techniques, crime scene protection, recording, processing, collection and preservation of evidence, fingerprint technology and legal aspects of evidence.

CJT 1310**Basic Firearms, 1 semester hour, 30 lab. (Offered as needed)**

Legal provisions and restrictions on the use of firearms and other police equipment. Range firing of weapons emphasizing deliverage, point, and defense shooting. Prerequisite: Open to criminal justice majors or with permission of instructor.

CJT 2100**Criminal Investigation, 3 semester hours, 45 lec. (Offered as needed)**

Fundamentals of investigation; duties and responsibilities of the detective's interrogation techniques; search and techniques of protecting the crime scene; collection and preservation of evidence; modus operandi systems; scientific aids and other sources of information; court preparation and case followup.

CJT 2140**Introduction to Criminalistics, 3 semester hours, 45 lec. (Fall, Spring)**

The scientific aspects of investigation and crime scene technology, crime laboratory functions, ballistics, dactyloscopy and latent print development, scientific methods of criminal identification. Prerequisite: Permission of instructor.

CJT 2220**Law Enforcement Photography, 3 semester hours, 45 lec. (Offered as needed)**

A basic course in police photography techniques to include photographic principles, illumination, composition, identification, fingerprint, crime scene, traffic accident, courtroom technician darkroom and film processing, enlarging, printing and field application. By permission of instructor. Prerequisite: CJT 2100 or XXX 6851 or CJT 2340.

CJT 2340**Police Operations, 3 semester hours, 45 lec. (Fall, Spring)**

Responsibilities, powers, and duties of the uniformed patrolman; patrol techniques and procedures; field interrogation and note-taking; mechanics of arrest and search; handling of the mentally ill; transportation of prisoners; elements of property protection; fundamentals of community relations; mob and riot control, traffic enforcement programs and techniques.



A BANNER in the foods area proclaims the festive message, "Happy 25th Anniversary" as shown before the crowd arrived.

*Occupational course that may not be applied toward the A.A. Degree.

CJT 2350***Writing and Reviewing Reports, 3 semester hours, 45 lec. (Offered as needed)**

Designed to give students a broad understanding of writing and reviewing criminal justice reports. Specifically designed for correctional and law enforcement officers.

CJT 2410**Traffic, 3 semester hours, 45 lec. (Offered as needed)**

A basic course in traffic fundamentals to include enforcement of the State of Florida Uniform Traffic Law, accident investigation techniques and control and regulation of traffic. Safe driving techniques will also be covered.

CJT 2430**Traffic Accident Investigation, 3 semester hours, 45 lec. (Offered as needed)**

Traffic law and arrest procedures, traffic accident reports, accident reconstruction, traffic accident investigation, homicide and hit-and-run investigation, interviews and interrogation.

CLP 1002**Personal Adjustment, 3 semester hours, 45 lec. (Fall, Spring, Summer)**

Psychology of adjustment, application of psychological theory for problem solving and better mental health. An examination of psychological defense mechanisms and adaptive behavior.

CLP 2140**Abnormal Psychology, 3 semester hours, 45 lec. (Offered as needed)**

A study of the different problems in psychopathology, including anxiety, depression, social deviance, psychosis, schizophrenia, both child and adult, mental retardation and general brain dysfunction, with emphasis on descriptive etiology, known causes, and treatments. Prerequisite: psychology course, permission of the instructor, or documented experience in an appropriate health related field.

COA 2100**Consumer Education, 3 semester hours, 45 lec. (Offered as needed)**

A study of the role of the consumer and consumer goods and services related to the home. The course will encourage wise planning and use of family resources.

COP 2000**Programming I, 3 semester hours, 45 lec. (Offered as needed)**

Designed for data processing majors, uses top-down design, structure logic, and a higher level language to solve problems on a computer. Stresses proper documentation of programs to be used in a computer center. Prerequisite: CIS 1000 or equivalent and proficiency in basic algebra required.

COP 2001**Programming II, 3 semester hours, 45 lec. (Offered as needed)**

A sequel to Programming I, intended to fully exercise all facilities of a high-level programming language in the solution of more advanced problems. Prerequisite: CIS 1000, COP 2000

COP 2200**FORTRAN Programming, 3 semester hours, 45 lec. (Offered as needed)**

An introduction to the computer programming language of FORTRAN. Includes general introduction to computer programming, general programming concepts, elementary problem solving and flowcharting. Involves actual problem solving by the use of the FORTRAN language on the computer. Prerequisites: CIS 1000, COP 2000, COP 2001, or equivalent.

COP 2120**COBOL Programming, 3 semester hours, 45 lec. (Offered as needed)**

A survey of an introduction to COBOL programming. Historical development, general concepts and state of the art. COBOL is introduced with emphasis on problem solving. Emphasis on methods of analyzing business problems for computer adaptation. Prerequisites: CIS 1000, COP 2000, COP 2001, or equivalent.

COP 2402**IBM Assembler Language, 3 credit hours, 45 lec. (Offered as needed)**

An introduction to assembler language programming for the IBM System/370 family of computers. Prerequisites: CIS 1000, COP 2000, COP 2001, or equivalent.

CRM 1011**Data Entry, 2 semester hours, 15 lec., 30 lab. (Offered as needed)**

Development of correct techniques, learning keyboard and development of manual skills.

CRW 2000**Creative Writing, 3 semester hours, 45 lec. (Offered as needed)**

Creativity in prose, poetry, and drama. All students creations are submitted to publisher's market.

CRW 2002**Creative Writing II, 3 semester hours, 45 lec. (Offered as needed)**

The student writes in one of the following genres: prose, poetry, or drama. The student submits his/her manuscript to a publisher. Prerequisite: a beginning writing course, evidence of substantial publication, or departmental permission.

CTE 1204**Wardrobe Imaging for Professionals, 3 semester hours, 45 lec. (Offered as needed)**

This course provides for the development of competency in planning individual and family wardrobes. Attention will be given to the effectiveness of clothing choices in professional situations. Factors to consider in purchasing wardrobe items are stressed as well as the care, maintenance and updating of various wardrobe components. Emphasis will be placed on the psychological and social factors influencing dress and the relationship of physical appearance to clothing selection.

CTE 1310**Clothing Selection and Construction I, 3 semester hours, 30 lec., 30 lab. (Fall and as needed)**

A basic course in clothing construction stressing judgement in the selection and use of commercial patterns, development of skill and understanding of construction techniques and fitting. A consideration of art principles as related to clothing.

CTE 1340**Clothing II, 3 semester hours, 30 lec., 30 lab. (Spring and as needed)**

Advanced problems and techniques of clothing construction and alterations. Prerequisite: CTE 1310 or permission of the instructor.

CTE 1401**Textiles, 3 semester hours, 45 lec. (Offered as needed)**

The study of fabrics used in clothing and home furnishings with emphasis on fibers, yarns, construction procedures, designs, and finishes that determine the qualities, performance, and care of fabrics.

*Occupational course that may not be applied toward the A.A. Degree.



THE OWCC JAZZ BAND, under direction of Bernie Bell, shown during a practice session.

CTE 2350

Tailoring, 3 semester hours, 30 lec., 30 lab. (Spring and as needed)

Tailoring principles and techniques of constructing, fitting and selecting tailored garments. Prerequisites: CTE 1310, CTE 1340.

CTE 2743

Creative Pattern Design, 3 credit hours, 30 lec., 30 lab. (Offered as needed)

A course designed for students with prior experience in clothing construction who are interested in designing garments for themselves and others. Major concepts of the course include: (1) elements and principles of design and their application to fashion; (2) constructing a basic pattern (a sloper). A garment of original design will be constructed in a laboratory setting.

DAA 1340

Folk Dance, 1 semester hour, 30 lab. (Offered as needed)

Instruction and participation in various Folk Dances.

DAA 1820

Dance Workshop, 1 semester hour, 30 lab (Offered as needed)

Instruction and participation in dance as required by specific Music Theatre productions. This course may be repeated for a maximum of four (4) credits.

DEP 2004

Human Growth and Development, 3 semester hours, 45 lec. (Fall, Spring, Summer)

A research-oriented course in human development, covering the life span of the human being from conception to death. Special emphasis placed upon the interrelationships of the stages of development of the normal person.

ECO 2013

Economics I, 3 semester hours, 45 lec. (Fall, or as needed)

Macroeconomics. Basic concepts and principles, national income accounting; fiscal and monetary policy and application, growth economics. Will satisfy General Education elective.

ECO 2023

Economics II, 3 semester hours, 45 lec. (Spring, or as needed)

Microeconomics. Economic structures, price theory, factor markets, and general equilibrium. Current national and international problems. World trade and balance of payments. Comparative economics. Will satisfy General Education Elective. Prerequisite: ECO 2013 or equivalent.

EET 1015C*

Basic Electricity/Electronics I, 5 semester hours, 30 lec., 135 lab. (Offered as needed)

The first course of the program introduces the electron theory, the theory, analysis, and troubleshooting of series, parallel and series parallel DC resistive circuits, network theorems, DC meters, magnetism, and electromagnetic induction. Laboratory safety is emphasized and extensive practice is given in the use of the VOM and electric voltmeter.

EET 1025C*

Electricity/Electronics II, 5 semester hours, 30 lec., 135 lab. (Offered as needed)

The second course introduces alternating current and the circuit properties of inductance and capacitance. Subjects covered are inductors, capacitors, the theory and analysis of resistance-inductance, resistance-capacitance, resistance-inductance-capacitance, and resonant circuits, filters and complex notation in alternating current circuits. Laboratory safety will continue to be emphasized and extensive practice given in use of the oscilloscope.

EET 1141G*

Devices and Circuits I, 5 semester hours, 30 lec., 135 lab. (Offered as needed)

Introduces semiconductor and PN junction theory. Circuits and devices covered are the junction diode, diode circuits, power supplies, bipolar junction transistor, transistor biasing, transistor circuits, FETs, and operational amplifiers. All circuits presented are built and tested in the laboratory.

EET 1142C*

Devices and Circuits II, 5 semester hours, 30 lec., 135 lab. (Offered as needed)

Continue the study of devices and circuits to include thyristors, power amplifiers, oscillators, transducers and actuators, optoelectronics, and an introduction to electronic communications.

EET 1606C*

Soldering/PC Board Techniques, 3 semester hours, 15 lec., 60 lab. (Offered as needed)

Courses teaches the knowledge and skills required in high reliability soldering. The student will work with and practice maintenance of quality soldering stations. Practice will be provided in non-destructive soldering and desoldering of discrete and integrated circuits using printed circuit cards.

EET 2322C*

Electronic Communications, 5 semester hours, 30 lec., 90 lab. (Offered as needed)

This course covers telecommunication technology to include modulation (amplitude, angle and pulse) single-sideband, AM and FM receivers, time division multiplex, digital communication, antennas, transmission lines, waveguides, laser communication and basic radar.

EEX 2010

Introduction to Exceptional Children, 3 semester hours, 45 lec. (Offered as needed)

Study of incidence, nature, etiology and services available in connection with exceptional children including: hearing and speech problems; learning disabilities, mental retardation, blind, physically handicapped, gifted, emotional conflicts, also parents of exceptional children. Prerequisites: PSY 2012 or permission of the instructor.

EGN 1120C

Engineering Graphics, 3 semester hours, 30 lec., 30 lab.

Use of instruments, lettering practice; geometric construction; multiview projection and conventions, auxiliary views, section views, axonometric and oblique projections, rotation, patterns and development, and methods of reproduction.

*Occupational course that may not be applied toward the A.A. Degree.

EGN 1130C**Descriptive Geometry, 3 semester hours, 30 lec., 30 lab. (Offered as needed)**

Basic principles of orthographic projection, auxiliary views and rotation as they apply to points, lines and planes in space; addition of coplanar and non-co-planar vectors; intersections and developments; and selected abstract, ex-pometric and oblique projection, and practical problems. Prerequisite: EGN 1120C or permission of the instructor.

EME 1920**Computer Application Skills Workshop, 1 semester hour, 20 lec. (Offered as needed)**

A workshop to provide an overview of computer applications to gain an understanding of hardware and software terminology and use, and supply an introduction to software utilization for the classroom teacher.

EMS 1059***First Responder, 4 semester hours, 60 lec. (Offered as needed)**

This course is designed for individuals planning careers in EMS, Fire Science, Law Enforcement, etc. who are interested in obtaining knowledge and skills necessary to provide optimum pre-hospital emergency care to the victim of trauma or sudden illness.

EMS 1065C**Cardiopulmonary Resuscitation, 1 semester hour, 10 lec., 5 lab. (Offered as needed)**

To train the lay-public in the essentials of prudent heart living. To give each trainee a background knowledge of the physiology of the cardiopulmonary system. To train each trainee in the motor skills involved in the application of CPR in the field and to clear obstructed airways.

EMS 1340C***Basic Extrication, 2 semester hours, 15 lec., 30 lab. (Offered as needed)**

This course is designed for students who have completed the basic EMT course, paramedic students, licensed EMT's, paramedics, and firefighters. The course provides the student with the principles, practices, and techniques of vehicular rescue. The emphasis of the course is basic rescue. Prerequisites: Completion of Basic EMT course, be a licensed EMT or firefighter, or have permission of instructor.

EMS 2119C**Emergency Medical Technology, 8 semester hours, 105 lec., 30 lab., 45 clinical hours (Offered as needed)**

Emergency Medical Technology is the first course of training for a career in emergency medical services. The course covers all techniques of emergency medical care considered within the responsibilities of emergency medical technicians as well as operation aspects of the profession. Prerequisite: First Aid/CPR or First Responder/CPR plus passing the entry reading exam required for college level courses (see current semester class schedule for minimum scores). Students must also pass a physical exam (forms are available from the OWCC Admissions office).

ENC 1000A****College Preparatory English, 3 semester hours, 30 lec., 45 lab. (Fall, Spring, Summer)**

This course is designed to move along as rapidly as possible toward full admission to degree programs those students whose entry level placement test scores do not meet requirements for degree credits. Skills appropriate to individual student needs are programmed in grammar, punctuation, spelling, syntax, and composition. This course may be repeated by students not fulfilling competency requirements. (State Board of Education Rules limit students to three registrations in this course.)

*Occupational course that may not be applied toward the A.A. Degree.

**College preparatory credits may not be counted towards fulfilling the number of credits required for a degree.

ENC 1139**Review of Essay and Writing Skills, 1 semester hour, 15 lec. (Fall, Spring, Summer)**

A short course reviewing standard English communication skills needed for coursework in a variety of disciplines. Prerequisite: Completion of English Communications I or equivalent.

ENC 1101**English Communications I, 3 semester hours, 45 lec. (Fall, Spring, Summer)**

Instruction and intense practice in expository and argumentative writing, including research paper and interpretive reading of essays. Prerequisite: A score in the 40th percentile or above on a standardized test measuring communications/verbal achievement.

ENC 1102**English Communications II, 3 semester hours, 45 lec. (Fall, Spring, Summer)**

Interpretive and critical reading of fiction (novel, novella, short-story), drama, poetry. Practice in the writing of descriptive and narrative discourse. Special practice in writing the library research term paper. Prerequisite: Completion of English Communications I or an equivalent course, with a grade of "C" or better.

ENC 1210**Technical Report Writing, 3 semester hours, 45 lec. (Offered as needed)**

The fundamentals of report writing, mechanics and style with practice in preparing various common types of reports. Prerequisite: ENC 1101 or LIN 1340.

ENC 2940**Directed Work Study - Communications, 1 semester hour (Fall, Spring, Summer)**

Directed experience in instructional, laboratory and/or materials assistance in a designated communication area. Entry coordinated through the department chair.

ENC 2941**Tutorial-Communications, 1 semester hour, 30 lab. (Fall, Spring, Summer)**

An experience in individual depth study in which one student prepares for and engages in tutoring another for two class periods per week.

ENG 1001**Research Papers, 1 semester hour, 16 lab. (Fall, Spring, Summer)**

A learn-by-doing course in the methods of conducting library research and writing a documented paper. Students will work in the library on self-selected subjects under the supervision and guidance of the instructor in a tutorial relationship. For successful completion, each student will write a paper documented with footnotes and bibliography in accordance with a standard system. NOTE: If this course is used to satisfy writing requirements for transfer courses to OWCC, a minimum grade of "C" is required.

ENG 2905**Independent Study-Literature, 1 semester hour (Offered as needed)**

A critical study and analysis of a specific literary figure or era. Offered and directed to meet the needs of students interested in such a specialization area. Entry coordinated through the department chair.

ENL 2011**English Literature I, 3 semester hours, 45 lec. (Offered as needed)**

A study of English literature from the Old English period (Beowulf) 449 through the Age of Reason (Johnson) 1709. With emphasis upon foreign writers who notably influenced English literature with an awareness of the influence of English writers upon the cultural and intellectual heritage of the Western World.

EPP 1015**Introduction to Education, 3 semester hours, 45 lec. (Fall, Spring, Summer)**

Orientation to the profession of teaching and an overview of education in a democratic society. Opportunities to observe activities in local schools. Visits and lectures by resource personnel.

EPP 2100**Educational Psychology, 3 semester hours, 45 lec. (Fall, Spring, Summer)**

Significant aspects of the growth and development of children and youth, including physical, social, and intellectual developments as they affect behavior patterns. Psychology as applied in improving the learning process.

EST 2112***Industrial Electronics, 5 semester hours, 30 lec., 90 lab. (Offered as needed)**

Courses will include the study of sensors, data acquisition and control, programmable controllers, motor speed controls, magnetic amplifiers, servomechanisms and introduction to robotics. Laboratory work will include experiments in industrial measurements, telemetry, systems, interface, process control and troubleshooting. The student will also perform experiments in the programming and control of an industrially representative robot arm. Prerequisite: Completion of the electronics core program or permission of department chair.

ETD 1111***Drafting I, 6 semester hours, 30 lec., 120 lab. (Offered as needed)**

The first of a sequence of courses in drafting which includes basic use of instruments, freehand lettering, geometric construction, orthographic projection, sections and conventions, conventional revolutions, dimensioning, inking, mechanical lettering, and methods of reproduction.

ETD 1221***Drafting II, 6 semester hours, 30 lec., 120 lab. (Offered as needed)**

A course that continues and completes the student's study of the fundamentals intrinsic to all types of drafting. Topics covered include isometric, dimetric, trimetric, oblique, and perspective projection, auxiliary views, related mathematics, precision dimensioning and inking practices. Prerequisite: ETD 1221.

ETD 1310***Intro Computer Drafting, 1 semester hour, 5 lec., 20 lab. (Offered as needed)**

A course designed to help drafting students develop knowledge and skills in the area of computer aided drafting. The course will include general background information on computer drafting theory as well as presentations on state-of-the-art computer drafting hardware. Prerequisite: ETD 1111 or EGN 1120C.

ETD 1311***Computer/Systems Drafting, 3 semester hours, 30 lec., 30 lab. (Offered as needed)**

A course designed to help students develop knowledge and skills in the areas of computer aided drafting and systems drafting. Topics covered include: computer aided drafting terminology; computer drafting hardware, software, and users; computer drafting hardware, software, and users; computer drafting applications; scissors drafting; reprographics; pin-registered overlay drafting; and team drafting. Prerequisite: 1310 or permission of instructor.

ETD 1653***PCB Drafting, 3 semester hours, 15 lec., 60 lab. (Offered as needed)**

A course to teach students principles of printed circuit board design, layout, and tape-on. Topics covered include: schematics logic, single side boards, multilayer boards, art-masters, fabrication drawings, and silkscreen masters. Prerequisite: EGN 1120C, ETD 1111, or permission of instructor.

ETD 1700***Drafting III, 6 semester hours, 30 lec., 120 lab. (Offered as needed)**

A course in the fundamentals of Mechanical and Machine Drafting. Topics covered include: Geometric dimensioning and true positional tolerancing; threads, nuts, bolts, screws, gears, cams and springs, drafting standards, and preparation of working drawings. Prerequisite: ETD 111, ETD 1221, ETD 1712 or permission of the instructor.

ETD 1712***Machine Design Drafting, 3 semester hours, 30 lec., 30 lab. (Offered as needed)**

A course in the fundamentals of geometric dimensioning and tolerancing. Topics covered include: definition and terms, symbology, datum referencing, locational tolerancing, form tolerancing, profile tolerancing, orientation and runout tolerancing, and math for positional tolerancing. Prerequisites: ETD 1111 and ETD 1221 or permission of instructor.

ETD 1801***Technical Illustration, 3 semester hours, 15 lec., 45 lab. (Offered as needed)**

The purpose of this course is to help students develop the skills, knowledge, and attitudes necessary to be job entry-level qualified as technical illustrators. Prerequisites: ETD 1111 or EGN 1120C and ETD 1221 or permission of instructor.

ETD 2011***Industrial Print Reading, 1 semester hour. (Offered as needed)**

The beginning level aspects of reading industrial prints such as drawing notes, title blocks, revision blocks, legends, schedules, multiviews, and parts list.



WHO needs charm school with smiles like these?

*Occupational course that may not be applied toward the A.A. Degree.

ETD 2351***Advanced Computer/System Drafting, 3 semester, 15 lec./60 lab hours. (Offered as needed)**

An advanced course designed to help students develop proficiency in the area of computer aided drafting and systems drafting. Topics covered include: transfer drawings, digitized drawings, eplanatory drawings, multiview projections, exploded assemblies, pictorial drawings, auxiliary views, sections, details, geometric dimensioning and tolerancing, and CADD concepts. Prerequisites: ETD 1311 or permission of instructor.

ETD 2655***Advanced PCB Drafting, 3 semester hours, 15 lec., 60 lab. (Offered as needed)**

A course to teach students advanced principles of printed circuit board design, layout, and tape-up. Topics covered include: schematics, artmasters, fabrication drawings, and silkscreen masters for double sided and multilayer boards. Prerequisites: ETD 1653 or permission of instructor.

ETD 2705***Advanced Mechanical Drafting, 3 semester hours, 15 lec./60 lab hours. (Offered as needed)**

An advanced course covering mechanical drafting, machine design, advanced dimensioning and tolerancing, and working drawings according to DOD and ANSI standards. Prerequisites: ETD 1700, ETD 1712, or permission of the instructor.

ETD 2534***Construction Drafting, 6 semester hours, 30 lec., 120 lab. (Offered as needed)**

A course to prepare students to develop shop drawings for large construction projects. Topics covered include: steel, precast concrete, prestressed concrete, poured-in-place concrete, and heavy timber construction projects. Prerequisites: EGN 1120C or ETD 1111 or permission of the instructor.

ETD 2731C***Structural Drafting, 3 semester hours, 15 lec., 60 lab. (Offered as needed)**

A course in the fundamentals of structural drafting including: an overview of structural drafting, prestressed concrete drafting, structural steel drafting, and poured on-site concrete drafting.

ETD 2905***Independent Study-Drafting, 1 semester hour (Fall, Spring, Summer)**

Practical treatment of special geometry, graphics, and design. Emphasis on individual work projects utilizing such graphical techniques as orthographic projection, perspective drawing, auxiliary views, topographic drawing, and graphing. Prerequisite: EGN 1120C or permission of instructor.

ETE 1100***Electronics for Drafters, 4 semester hours, 60 lec. (Offered as needed)**

An introductory course in electronics for drafters, designers, and beginning electronics technicians; designed to provide a basic understanding of electronic principles, theories and concepts.

ETG 1110***Electronics Computations, 4 semester hours, 60 lec. (Offered as needed)**

This course is designed to provide practical application of computations relating directly to electronics. It provides active, intensive application of basic mathematical theories and formulas to the analysis and solution of real world electronics problems. Prerequisite: Intermediate Algebra or permission of instructor.

ETG 1941***Internship-Technical Education, 3 semester hours, 225 lab hours (Offered as needed)**

On-the-job training in the Associate of Science or Associate of Science/Applied Science Option degree program in which the student is enrolled. The student is under the supervision at work of a qualified supervisor. The supervisor will rate the student's performance, knowledge, comprehension, dependability, initiative, cooperativeness, and total performance. A project paper or approved project will be submitted by the student three weeks prior to the close of the semester. May be repeated four times for a total of 12 semester hours. Corequisite: Must be enrolled in at least one other course in the respective degree program.

ETG 2905***Independent Study-Electronics, 1 semester hour (Fall, Spring, Summer)**

Directed study and individual projects designed to meet the needs of students interested in a specialized area of electronics for which present course availability is limited.

ETI 2906***Tutorial-Industrial-Technical, 1 semester hour (Offered as needed)**

A program which awards credit recognition to outstanding students who volunteer to assist or tutor other students having remedial and specific academic or laboratory needs in a designated subject. Student tutors are recommended by faculty teaching a designated course and are supervised through the Counseling Office.

ETI 2940***Directed Work Study-Industrial-Technical, 1 semester hour, 45 lab. (Fall, Spring, Summer)**

Directed experience in instructional, laboratory and/or materials assistance in a designated industrial-technical area. Entry by permission of department chair only.

FAD 1123**Adults in a Changing Society, 3 semester hours, 45 lec. (Fall, Spring, Summer)**

Directed experience in instructional, laboratory and/or materials assistance in a designated industrial-technical area. Entry by permission of department chair only.

FFP 1000***Introduction to Fire Science, 3 semester hours, 45 lec. (Offered as needed)**

A study of the phenomena and incidents of fire; the principles of fire prevention, suppression, and protection; a review of municipal fire protection ratings and components; survey of professional fire protection career opportunities.

FFP 1100***Fire Protection, Organization and Administration, 3 semester hours, 45 lec. (Fall, Summer)**

Principles of organization and administration in fire protection service; the structure and function of battalion and company as components of municipal organizations; duties and responsibilities of the company officer; a study of company personnel management and training, budgeting, records, reports, and public relations.

FFP 2200***Fundamentals of Fire Prevention, 3 semester hours, 45 lec. (Fall, Spring)**

Fire prevention organization; techniques of fire prevention interpretation and application of fire code; recognition and elimination of fire hazards; fundamentals of public relations for fire services.

*Occupational course that may not be applied toward the A.A. Degree.

FFP 2240***Arson Detection and Investigation, 3 semester hours, 45 lec. (Offered as needed)**

An introduction to arson laws and types of incendiary fires. Students learn methods of determining fire cause, recognizing and preserving evidence, etc. Prerequisite: Sophomore standing in Fire Science Technology or employed Firefighter, or permission of the instructor.

FFP 2300***Fire Codes and Building Construction, 3 semester hours, 45 lec. (Spring, Summer)**

A study of fire codes and standards used in building and transportation; role of the State Fire Marshall; fixed fire protection devices; survey of research and standards development. Prerequisite: Introduction to Fire Science.

FFP 2410***Fire Fighting Tactics and Strategy I, 3 semester hours, 45 lec. (Fall, Spring)**

A study of the basic concepts involved in fire fighting; including fire behavior; fire fighting fundamentals; principles of extinguishment; the proper role for utilization of various fire companies; pre-planning fire problems. Prerequisite: Introduction to Fire Science.

FFP 2420***Fire Fighting Tactics and Strategy II, 3 semester hours (Spring, Summer)**

A study of the principles utilized on fire ground for maximum manpower and equipment utilization; fire ground administration starting with a small fire, on up through major conflagrations, emphasis will be on developing thinking skills in relation to crisis. Prerequisite: Fire Fighting Tactics and Strategy I.

FFP 2500***Explosives and Hazardous Material I, 3 semester hours, 45 lec. (Offered as needed)**

Storage, handling laws, standards, and fire fighting practices pertaining to hazardous solids, liquids, gases, and commercial explosives.

FFP 2501***Explosives and Hazardous Material II, 3 semester hours, 45 lec. (Offered as needed)**

Prepares student to deal with explosive hazardous materials to include; identification, storage, handling, laws, standards and fire fighting practices relating to hazardous solids, liquids, gases, and commercial explosives; hazardous team operations, safety practices, incident command at chemical incidents; scene operations and control techniques.

FFP 2600***Fire Apparatus, 3 semester hours, 45 lec. (Fall, Spring) (Offered as needed)**

Principles and operation of ladder trucks, pumping engines, and other specialized equipment. Includes study of basic hydraulics.

FFP 2620***Automatic Alarm and Extinguishing Systems, 3 semester hours, 45 lec. (Spring, Summer)**

A study of the types of fixed extinguishing systems, standard and special fire alarm and fire detection systems. Includes their operation, installation requirements, testing, inspection, maintenance.

FFP 2640***Fire Service Hydraulics, 3 semester hours, 30 lec., 30 lab. (Offered as needed)**

A study of the physical laws relating to hydrostatics (fluids at rest) and hydrokinetics (fluids in motion). This course also provides practical experience in performing fire flow tests, pump performance tests and in calculating friction loss in various size hose. Prerequisite: Fire Protection, Organization and Administration or permission of the instructor.

FRE 1100**French I, 4 semester hours, 60 lec. (Fall and Term I Summer)**

Pronunciation and grammatical structures of French, with emphasis upon balanced development of all four skills — listening, speaking, reading, and writing. Covers all basic structures of the language. Students who have successfully completed two or three years of high school French should enroll in French III-IV.

FRE 1101**French II, 4 semester hours, 60 lec. (Offered Spring and Term II Summer)**

Pronunciation and grammatical structures of French, with emphasis upon balanced development of all four skills — listening, speaking, reading and writing. Covers all basic structures of the language. Students who have successfully completed three years of high school French should enroll in French III-IV.

FRE 2200**French III, 4 semester hours, 60 lec. (Offered Fall and Summer Term I)**

Intermediate level review of grammar, readings in French literature, and development of conversational and writing skills. Prerequisite: Two or three years of high school French with grade of "B" or better, or FRE 1100 and 1101 or its equivalent.

FRE 2201**French IV, 4 semester hours, 60 lec. (Offered Fall and Summer Term II)**

Completion of intermediate level review of grammar, reading in French literature, and development of conversational and writing skills. Prerequisite: three years of high school French with grade of "B" or better, or FRE 2200 or its equivalent.



PADDLE BALL is one of many recreational sports offered at OWCC. Others include badminton, volleyball, basketball, canoeing, golf, tennis, etc.

*Occupational course that may not be applied toward the A.A. Degree.

FRW 2100**Introduction to French Literature I, 3 semester hours, 45 lec. (Offered as needed)**

The development of French literature from the beginning to the present. Prerequisite: FRE 2201 or its equivalent.

FRW 2101**Introduction to French Literature II, 3 semester hours, 45 lec. (Offered as needed)**

The development of French literature from the beginning to the present. Prerequisite: FRE 2201 or its equivalent.

FSS 1202C***Beginning food Preparation I, 6 semester hours, 45 lec., 135 lab. (Offered as needed)**

The first course in the commercial foods program. Topics covered include: safe operation of food preparation equipment, beginning food preparation skills, food preparation utensils, desirable work habits, safety practices, and human relations.

FSS 1203C***Beginning Food Preparation II, 6 semester hours, 45 lec., 135 lab. (Offered as needed)**

A study of basic food preparation on a small quantity basis. Topics covered include: preparation of meats, vegetables, salads, and desserts; the three basic food groups and their relationship to nutrition; vitamin and mineral content of foods and their relationship to good health.

FSS 1210C***Family Meal Planning, 3 semester hours, 30 lec., 30 lab. (Offered as needed)**

A basic study of foods and principles underlying meal planning, food selection, preparation and service. A consideration of the essentials of an adequate diet.

FSS 1220C***Introduction to Commercial Foods and Catering, 4 semester hours, 30 lec., 60 lab. (Offered as needed)**

An introductory course in commercial food preparation and catering. The student will develop knowledge and skill in the preparation of food, including preparation used in the food service industry. Laboratory experiences are required.

FSS 1221***Quantity Foods Preparation I, 6 semester hours, 45 lec., 135 lab. (Offered as needed)**

A study of food preparation in quantity. Topics covered include: wholesale and retail cuts of meat; time and temperature factors in quantity cooking; balanced nutritional menu planning; the U.S. Department of Agriculture grading system for meats; complimenting meals with salads and baked goods.

FSS 1222***Quantity Foods Preparation II, 6 semester hours, 45 lec., 135 lab. (Offered as needed)**

An advanced study of quantity food preparation. Topics covered include: progressive cooking for large groups of people; and advanced menu planning for large groups.

FSS 1246C***Commercial Baking, 6 semester hours, 45 lec., 135 lab. (Offered as needed)**

A study of baking practices and principles as they apply to the preparation of breads, rolls, pastries, pies, cakes, cookies, and specialty desserts.

FSS 1292**Using Energy Saving Appliances in Cooking, 1 semester hour, 15 lec., 5 lab. (Offered as needed)**

The basic operation of the energy saving appliances and use in cooking techniques for various foods.

GEB 1011**Introduction to Business, 3 semester hours, 45 lec. (Fall, Spring, Summer)**

Designed to give students a broad understanding of the nature of business and a preliminary idea of the various areas of business specialization.

GEB 1940***Internship-Business Education, 3 semester hours, 225 lab. (Offered as needed)**

On-the-job training in the Associate of Science/Applied Science Option program in which the student is enrolled. The student is under the supervision at work of a qualified supervisor. The supervisor will rate the student's performance, knowledge, comprehension, dependability, initiative, cooperativeness, and total performance. A project paper or approved project will be submitted by the student three weeks prior to the close of the semester. May be repeated four times for a total of 12 semester hours.

GEB 2903**Tutorial-Business, 1 semester hour, 30 hours (Fall, Spring, Summer)**

An experience in individual depth study in which one student prepares for and engages in tutoring another for two class periods per week.

GER 1100**German I, 4 semester hours, 60 lec. (Fall)**

Functional development of understanding of spoken and written German, with emphasis upon balanced development of all four skills — listening, speaking, reading, and writing. Covers all basic structures of the language. Students who have successfully completed two or three years of high school German should enroll in German III-IV.

GER 1101**German II, 4 semester hours, 60 lec. (Spring)**

Functional development of understanding of spoken and written German, with emphasis upon balanced development of all four skills—listening, speaking, reading, and writing. Covers all basic structures of the language. Students who have successfully completed two or three years of high school German should enroll in German III-IV. Prerequisite: German I or equivalent.

GER 2200**German III, 4 semester hours, 60 lec. (Fall)**

Intermediate level review of grammar, readings in contemporary literature and current affairs, audio-lingual practice, and development of conversational and writing skills. Prerequisite: German I-II or two years or more in high school German with a grade of "B" or better, or equivalent.

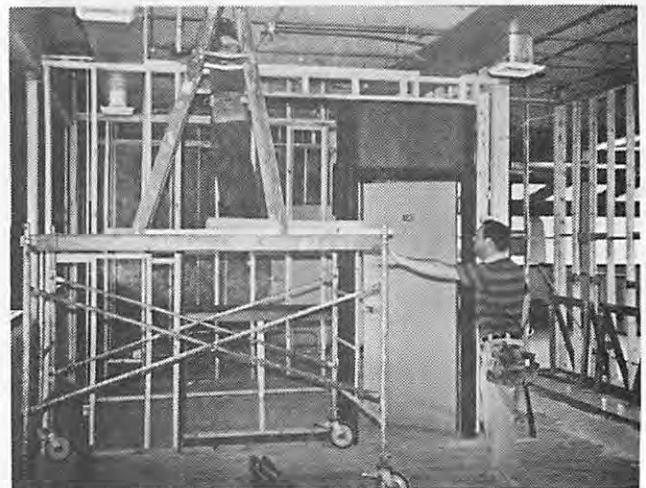

RENOVATION of "C" building in progress. The building will house Student Services upon completion.

*Occupational course that may not be applied toward the A.A. Degree.

GER 2201**German IV, 4 semester hours, 60 lec. (Spring)**

Completion of intermediate level review of grammar, readings in contemporary literature and current affairs, audio-lingual practice, and development of conversational and writing skills. Prerequisite: three years of high school German with grade of "B" or better, or GER 2200 or its equivalent.

GER 2420**Advanced German Grammar and Composition I, 3 semester hours, 45 lec. (Offered Fall or when needed)**

Study of advanced grammatical structures, selected development of vocabulary and idiom, practice in oral and written composition. Prerequisite: GER 2201 or four years of high school German.

GER 2421**Advanced German Grammar and Composition II, 3 semester hours, 45 lec. (Offered Spring or when needed)**

Study of advanced grammatical structures, selected development of vocabulary and idiom, practice in oral and written composition. Prerequisite: GER 2201 or four years in high school German.

GER 2440**Business German, 3 semester hours, 45 lec. (Offered as needed)**

Business German will include readings from current German essays and news articles sampling all aspects of business writing. The student will practice forms of business communications: letters, advertising, forms for bills of lading, invoices, explanations of business procedures, etc. Prerequisite: Equivalent of German I, II, III, IV, mastery of intermediate level of German.

GER 2905**Independent Study-German, 1 semester hour (Offered as needed)**

Directed study designed to meet needs of students interested in specific areas of German language and literature for which the present course offerings are limited. Permission of department chair required.

GEW 2010**Introduction to German Literature I, 3 semester hours, 45 lec. (Offered Fall or when needed)**

The development of German literature from the Middle Ages to the present: first semester to 1833. Prerequisite: Ger 2201 or equivalent.

GEW 2011**Introduction to German Literature II, 3 semester hours, 45 lec. (Offered Spring or when needed)**

The development of German Literature from the Middle Ages to the present; second semester from 1833 to the present. Prerequisite: GER 2201 or equivalent.

GLY 1001**Earth Science, 4 semester hours, 60 lec. (Fall, Spring, Summer)**

Survey of processes, materials and structure of the solid earth, oceanography, meteorology, and the relation of the earth to other planets. Intended for physical science general education requirement. Practical exercises in mineral and rock identification.

GLY 1100C**Historical Geology, 4 semester hours, 45 lec., 30 lab. (Offered as needed)**

A study of the history of the earth, including the origin of continents, mountains and ocean basins as recorded in rocks and fossils. A survey of the fossil record and changes in animal and plant life throughout geological time will also be studied. Prerequisite: GLY 1001 or equivalent (a physical geology course).

GRA 1530C***Typography, 3 semester hours, 30 lec., 30 lab. (Offered as needed)**

A comprehensive introduction, overview and practical application relating to the principles of design and the use of letter forms. Stresses the feeling and visual impact in the design and use of different lettering styles. Prerequisites: ART 1300, ART 1201.

GRA 1534C***Electronic Composition, 4 semester hours, 30 lec., 60 lab. (Offered as needed)**

Classroom and lab experiences pertaining to the uses and applications of interactive display and markup/makeup systems utilizing software programming to generate, display, edit and compose images electronically. Prerequisites: GRA 1541C, GRA 1542C and OST 1100.

GRA 1541C***Introduction to Copy Preparation, 4 semester hours, 30 lec., 60 lab. (Offered as needed)**

Comprehensive overview and practical experiences relating to fundamentals, techniques, procedures and tools used in the preparation of copy for offset printing.

GRA 1542C***Phototypesetting, 4 semester hours, 30 lec., 60 lab. (Offered as needed)**

Comprehensive study and practical experiences relating to more technical and advanced methods of preparing copy for offset printing. Prerequisite: OST 1100 or equivalent and GRA 1541C.

GRA 1543C***Graphic/Commercial Design I, 3 semester hours, 30 lec., 30 lab. (Offered as needed)**

A comprehensive introduction, overview and practical experience relating to the basic fundamentals, techniques, procedures, principles, and tools used in graphic/commercial art. Prerequisites: ART 1300, ART 1201, GRA 1541C, GRA 1571C.

GRA 1571C***Process Camera I, 4 semester hours, 30 lec., 60 lab. (Offered as needed)**

This course will provide a comprehensive study of and practical experience in the areas of: process camera work, stripping techniques, proofing methods and offset platemaking.

GRA 1573C***Process Camera II, 4 semester hours, 30 lec., 60 lab. (Offered as needed)**

This course is a continuation of Process Camera I, with advanced techniques and processes included, such as: halftone, duotones, and the use of Color-Key for proofing. Prerequisite: GRA 1571C.

GRA 1601C***Fake Color Assembly, 3 semester hours, 30 lec., 30 lab. (Offered as needed)**

This course will provide comprehensive experience in the advanced film assembly technique of mechanical color separation, known as "Fake Color." Prerequisites: GRA 1571C, GRA 1753C.

GRA 1636C***Small Offset Press Operations, 4 semester hours, 30 lec., 60 lab. (Offered as needed)**

Comprehensive study of, and practical experience on a small sheet-fed offset press. Course includes press make-ready, operation adjustments, and maintenance.

*Occupational course that may not be applied toward the A.A. Degree.

GRA 1706***Printing Estimating, 3 semester hours, 45 lec. (Offered as needed)**

This course will provide for a study of the many factors and problems to be considered by a Printing Estimator to arrive at a quotation for a production job.

GRA 2500C***Printing Materials and Processes, 3 semester hours, 30 lec., 30 lab. (Offered as needed)**

Discussion of printing materials and processes, equipment and terminology, bindery operations, and career opportunities in the printing industry.

GRA 2544C***Graphic/Commercial Design II, 3 semester hours, 30 lec., 30 lab. (Offered as needed)**

Comprehensive overview and practical experience relating to advanced procedures and specialized areas of interest in the graphic/commercial art field. Prerequisites: ART 1300, ART 1201, GRA 1541C, GRA 1571C, GRA 1543C.

GRA 2547C***Projects in Graphic Design, 3 semester hours, 30 lec., 30 lab (Offered as needed)**

Comprehensive introduction, overview and practical experience relating to the fundamentals and techniques of graphic/commercial art studio procedures, design and production. Prerequisites: ART 1300, ART 1201, GRA 1541C, GRA 1571C, GRA 1543C, GRA 2544C.

GRA 2602C***Process Color Film Assembly, 3 semester hours, 30 lec., 30 lab. (Offered as needed)**

This course provides practical experience in the film assembly and the making of proofs from four-color process separation negatives. Prerequisites: GRA 1571C, GRA 1573C, and GRA 1601C.

GRA 2635C***Offset Presswork I, 4 semester hours, 30 lec., 60 lab. (Offered as needed)**

This course provides practical experience of production printing done on a small offset press and the various finishing operations that a job might require before it is completed. Prerequisite or corequisite: GRA 1636C.

GRA 2637C**Offset Presswork II, 4 semester hours, 30 lec., 60 lab. (Offered as needed)**

This course provides practical experience of production printing done on a large offset press and the various finishing press. Prerequisite: GRA 2635C.

GRA 2905***Independent Study-Graphics/Printing, 1 semester hour, 45 lab. (Offered as needed)**

Practical treatment of graphics/printing technology within the field of offset printing. Emphasis on individual work projects utilizing such areas as copy preparation, darkroom work, stripping and platemaking; press operation, and bindery operation. Prerequisite: Permission of instructor.

GRA 2949***Directed Work Study-Graphics/Printing, 1 semester hour, 45 lab. (Offered as needed)**

Directed experience in instructional, laboratory and/or materials assistance in a designed graphics/printing area. Prerequisite: Permission of instructor.

HFT 2000**Hospitality Management, 3 semester hours, 45 lec. (Offered as needed)**

An introductory study of problems originating in the operation and administration of various segments of the hospitality industry. Prerequisites: ACG 2001, ACG 2011, OST 2335, MAN 2021, MAR 2011, MKA 2302, MNA 2100, MAR 2101, CGS 1060, ECO 2013.

HFT 2261***Restaurant Management I, 6 semester hours, 45 lec., 135 lab. (Offered as needed)**

A course designed to provide the student with the general principles of production management, work scheduling and preparation supervision.

HFT 2262***Restaurant Management II, 6 semester hours, 45 lec., 135 lab. (Offered as needed)**

A course designed to provide the student with the general principles of total food service management, menu planning, purchasing, inventory control, cost control and service techniques.

HFT 2940**Hospitality Management Internship, 6 semester hours, 90 lec. (Offered as needed)**

A management internship program providing on-the-job management experiences in various phases of the hospitality industry.

HHD 1321**Basic Home Decorating, 1 semester hour, 15 lec. (Offered as needed)**

Basic study of home decorating principles and techniques; analyzing decorating needs and priorities; inexpensive ideas for creating individual and inviting atmosphere in the home through buying wisely, making needed items, or using existing home furnishings.

HHD 2110**Home Planning and Furnishing, 3 semester hours, 45 lec. (Offered as needed)**

A basic course in home planning, selection, use and care of equipment and furnishings for family living. Consideration of art principles in planning livable interiors, and current trends in housing.



THE EQUITY and Personnel Officer, William T. Hall, Jr., and his secretary, Edna Washington.

*Occupational course that may not be applied toward the A.A. Degree.

HLP 1081

Wellness: Practice and Theory, 3 semester hours, 45 lec. (May apply toward activity PE requirement). (Offered as needed)

A course designed to provide the basis for scientifically selecting those habits, behaviors and programs which, if applied, will enable the individual to maintain a high quality of health and total fitness throughout life. Based on assessment test results. Physical examination by a physician may be recommended.

HME 1200

Home Management I, 1 semester hour, 15 lec. (Offered as needed)

Basic course in managing the home as related to individual and family activities; includes principles of positive interaction of family members as well as time and energy management applied to housekeeping tasks of providing and maintaining food, shelter, and clothing, and good communication for family members.

HOE 1010

Introduction to Home Economics, 3 semester hours, 45 lec. (Offered as needed)

Introduction to Home Economics as a career field of study; a consideration of history, professional opportunities, problems and current trends.

HOE 2905

Independent Study-Home Economics, 1 semester hour, 30 lec., 30 lab. (Fall, Spring, Summer)

Directed study in individual projects designed to meet the needs of students interested in specialized areas of Home Economics for which present course availability is limited. Areas of study can also supplement present Home Economics courses for special emphasis of depth. Recommendation by department chair.

HOE 2906

Directed Work Study-Home Economics, 1 semester hour, 45 hours (Fall, Spring, Summer)

Directed experience in instructional, laboratory and/or materials assistance in a designated Home Economics area. Entry by permission of department chair only.

HOE 2907

Tutorial-Home Economics, 1 semester hour, 30 lec. (Fall, Spring, Summer)

An experience in individual depth study in which one student prepares for and engages in tutoring one or more students for two class periods per week. The student will assist other students having remedial and specific needs (academic or laboratory) in a designated area in Home Economics. Recommendation by department chair.

HOS 1010

Basic Horticulture, 3 semester hours, 45 lec., 45 lab. (Offered as needed)

A study of the principles and practices of plant growth and reproduction, plant propagation, ornamental plantings, and proper use of insecticides and pesticides.

HSC 1100

Health Concepts, 3 semester hours, 45 lec. (Offered as needed)

A systematic and comprehensive coverage of basic factual material, concepts, terminology, and important trends in major health areas of concern today.

HSC 1400

First Aid, 3 semester hours, 45 lec. (Offered as needed)

Preparation to meet emergencies that occur in the school, home or on the highway. Instruction and practice in dressing and bandaging, care of wounds, shock, bone and joint injuries, cardio-pulmonary resuscitation, transportation of the injured, oral poisoning and other medical emergencies.

HUM 1020

Humanities-Introduction, 3 semester hours, 45 lec. (Offered as needed)

Techniques, forms, and basic evaluative tools related to music, the visual arts, poetry, drama, the dance, film, and philosophy. Art works are utilized as much as possible with examples relating to contemporary culture.

HUM 1095

Independent Study-Arts and Humanities, 1 semester hour, 45 hours (Offered as needed)

A defined independent study which is pursued under supervision of a faculty directing teacher and recorded through departmental procedures. Designed to permit a student to pursue non-scheduled academic and laboratory work which may be of a specialized or advanced nature and not available through classes or courses available on a college schedule. The student must obtain proper department approval prior to commencing the independent study.

HUM 2905

Directed Work Study-Art Humanities, 1 semester hour, 45 hours (Offered as needed)

Directed experience in instructional, laboratory and/or materials assistance in a designated Arts-Humanities area.

HUM 2906

Tutorial-Arts and Humanities, 1 semester hour, 30 lab. (Offered as needed)

An experience in individual depth study in which one student prepares for and engages in tutoring another for two class periods per week.

HUN 2001

Nutrition, 3 semester hours, 45 lec. (Offered as needed)

The role of nutrients in maintenance of physiological well-being. Application of nutrition principles to the individual and family as well as to some selected problems.

HUN 2410

Child Nutrition and Health, 3 semester hours, 30 lec., 30 lab. (Offered as needed)

Methods of meeting physical needs of young children through nutrition and good health practices. Recognition of childhood diseases and care of the handicapped child.



WELCOME! Dr. Ron Head, Chairman, Science and Math Division, welcomes the nine schools from three counties which participated in the 2nd Annual Math Bowl held at the college March 10, 1989.

HUS 1400**Peer Advising, 3 semester hours, 30 lec., 30 lab. (Offered as needed)**

A course in techniques of peer advising focusing on communication skills, professional ethics, and knowledge of community resources for referral purposes; to be used under professional supervision in human service agencies and organizations.

INR 2065**War and Civilization, 3 semester hours, 45 lec. (Offered as needed)**

An analytical and historical study of warfare from its earliest beginnings to the present day stressing the impact of war on the social, economic, and political structure of civilization.

INR 2002**Current World Problems, 3 semester hours, 45 lec. (Summer)**

Critical world issues and immediate troubled areas against a historical, political, economic, and social background as an introduction to international relations. The individual student develops a special area of interest to explore in-depth the principles of international relations after their instruction.

ISS 1905**Independent Study-Social Science, 1 semester hour, 45 hours (Offered as needed)**

Directed study and individual projects designed to meet the needs of students interested in a specialized area of the social sciences for which present course availability is limited.

ISS 2905**Directed Work Study-Social Science, 1 semester hour, 45 hours (Offered as needed)**

Entry by permission of department chair only.

ISS 2943**Tutorial-Social Studies, 1 semester hour, 30 hours (Fall, Spring, Summer)**

An experience in individual depth study in which one student prepares for and engages in tutoring another for two class periods per week. Prerequisite: Departmental permission.

JOU 1100**Journalism I, 3 semester hours, 15 lec., 30 lab. (Offered as needed)**

Teaches the basics of straight news story writing, photography, copy preparation, editing, layout, and design of publications with an emphasis on newspapers and magazines. Prerequisite: High School English and typing preferable.

JOU 1103**Journalism II, 3 semester hours, 15 lec., 30 lab. (Offered as needed)**

Introduces the student to the art of feature writing, including the basics of finding a good story idea, researching the periodicals market, sending query letters, and marketing the finished project. The course also teaches the mechanics of writing leads, building the body of the story and proper closing.

LEA 1101**Introduction to Civil Law, 3 semester hours, 45 lec.**

An insight into the system of dispute resolution for private parties and the government provided by the court systems of the various states and the Federal Government in a non-criminal setting.

LEA 1935**Introduction to Paralegalism, 3 semester hours, 45 lec. (Offered as needed)**

Designed to give students a broad understanding of the nature of the paralegal professional and its responsibility.

LEA 1936**Legal Research, 3 semester hours, 45 lec. (Offered as needed)**

The student is systematically introduced to the essentials of legal research in such areas as searching for precedence, gathering citations and legal opinions, preparing legal briefs and conducting title searches.

LEA 2151**TORTS: Personal Injury Litigation, 3 semester hours, 45 lec. (Offered as needed)**

This course is designed to provide the student with an introductory knowledge of tort law with objectives centered on personal injury torts.

LEA 2937**Rules of Evidence, 3 semester hours, 45 lec. (Offered as needed)**

The student is introduced to the rules of evidence as they apply in civil and criminal court procedures. The student is prepared to locate legal case law in reference to evidence.

LEI 1000**Introduction to Recreation, 3 semester hours, 45 lec. (Offered as needed)**

The course will provide information about the nature and organization of recreational activities. Its purpose is to inform students about the preparation of recreational professionals; where they perform and the need of their services; to teach qualifications needed in their work, and the problems and challenges they will meet in the job.

LEI 2330**Camp Counseling, 3 semester hours, 30 lec., 30 lab. (Fall, Spring)**

The training of camp counselors in organizing camping, including camp crafts, nature, and informal activities.

LIN 1340**Writing: Grammar and Syntax, 3 semester hours, 45 lec. (Fall, Spring, Summer)**

Development and review of skills in expository writing: grammar, syntax, punctuation, spelling, style, and manuscript form. Prerequisite: Basic language skills.

LIS 2001**Independent Study-Library, 1 semester hour, 45 hours (Offered as needed)**

Directed study designed to acquaint the student with the works of the various departments necessary for a well-organized library. Entry by permission of LRC Director only.

LIT 2100**Approach to Literature, 3 semester hours, 45 lec. (Fall, Spring, Summer)**

Designed to encourage students to know and appreciate something of the great literature which helps to mold their thinking and everyday living. To include, without regard to national origin, those masterpieces of the Western World which reflect their cultural and intellectual heritage.

LIT 2090**Contemporary Literature, 3 semester hours, 45 lec.**

Studies in modern drama, prose, and poetry, focusing on their comments on modern man. May be used as Humanities credit.

MAC 1102**Introductory College Algebra, 3 semester hours, 45 lec. (Fall, Spring, Summer)**

Includes extended factorization techniques; higher order radicals and roots; in-depth study of quadratic equations and inequalities, including use of determinants; study of functions, their properties and uses, graphs of linear and quadratic functions; the complex number system, absolute value equations and inequalities and an emphasis on word problems. Prerequisites: Satisfactory completion of MAT 1024A, or equivalent.

MAC 1114**Trigonometry, 3 semester hours, 45 lec. (Fall, Spring, Summer)**

Typical modern trigonometry course. Prerequisite: MAC 1140 with a grade of "C" or better, or equivalent.

MAC 1140**Pre-Calculus Algebra, 3 semester hours, 45 lec. (Fall, Spring, Summer)**

First course in a three-course pre-calculus sequence. Covers equations and inequalities; linear, quadratic, logarithmic and exponential functions and relations; systems of equations; matrices and determinants, mathematical proof techniques, including mathematical induction. Binomial theorem, sequences and series; and applications of algebraic techniques in the real world. Scientific-type calculators are used in logarithmic and exponential work. Prerequisite: Completion of MAC 1102 with a grade of "C" or better, or equivalent.

MAC 1142**Pre-Calculus Mathematics, 5 semester hours, 75 lec. (Offered as needed)**

An accelerated course covering selected topics from college algebra, trigonometry and analytic geometry. Course is designed for student with above average backgrounds in mathematics who plan to enter the calculus sequence. Prerequisite: Completion of courses in trigonometry and analytic geometry with grades of "C" or better, or equivalent.

MAC 1154**Analytical Geometry, 3 semester hours, 45 lec. (Fall, Spring, Summer)**

Typical modern analytic geometry course in two and three space. Prerequisite: Completion of MAC 1140 and MAC 1114 with a grade of "C" or better, or equivalent.

MAC 1411**Calculus I, 4 semester hours, 60 lec. (Fall, Spring, Summer)**

First course in a three course sequence. Covers basic concepts of differentiation and integration. Prerequisite: MAC 1140 and MAC 1114 and MAC 1154 with a grade of "C" or better, or equivalent.

MAC 1412**Calculus II, 4 semester hours, 60 lec. (Fall, Spring, Summer)**

Second course in a three course sequence, and provides further insight into the methods and applications of differentiation and integration. Prerequisite: Completion of MAC 1411 with a grade of "C" or better, or equivalent.

MAC 1413**Calculus III, 4 semester hours, 60 lec. (Fall, Spring, Summer)**

Third course in a three course sequence: It stresses multivariable calculus and infinite series. Prerequisite: Completion of MAC 1412 with a grade of "C" or better, or equivalent.

MAC 2233**Calculus for Business, 3 semester hours, 45 lec. (Offered as needed)**

A calculus course covering limits, continuity, differentiation, and integration with emphasis on business applications. There is some mathematical theory; but, in general, topics are approached from an intuitive and applied point of view. Prerequisite: Grade of "C" or better in MAC 1140 or equivalent.

MAE 2810**Mathematics for Elementary Teachers, 3 semester hours, 45 lec. (Offered as needed)**

Designed for elementary education majors in preparation for teaching contemporary elementary mathematics. Covers problem solving, numeration systems, whole numbers, integers, number theory, rational numbers and fractions, decimals, real numbers, introductory geometry, geometric construction, and concepts of measurements. Prerequisite: Completion of general education mathematics requirements.

MAN 2021**Management, 3 semester hours, 45 lec. (Offered as needed)**

Each function of management is analyzed and described in a systematic manner. Both the distilled experience of practical managers and the findings of scholars are presented. Other aspects of management are presented such as management process and concepts analysis of the technical knowledge and skills of managers, influences upon managerial decision-making process, and the psychological principles inherent in management.

MAN 2905**Independent Study-Business, 1 semester hour, 15 lec., 30 lab. (Fall Spring, Summer)**

Directed study and individual projects designed to meet the needs of students interested in specialized areas of business for which present course availability is limited. Areas of study can also be supplemented to present business courses for special emphasis or depth.



OWCC HOSTED the community colleges in the northern region for the first round of Community College Brain Bowl competition in 1988. OWCC's team sits to the right.

MAN 2940**Directed Work Study-Business, 1 semester hour, 45 lab. (Fall, Spring, Summer)**

Directed experience in instructional, laboratory and/or materials assistance in a designated business area.

MAP 2302**Differential Equations, 3 semester hours, 45 lec. (Spring or as needed)**

Course presents the basic concepts and theory of first course in ordinary differential equations. Prerequisite: Completion of MAC 1413 with a grade of "C" or better, or equivalent.

MAR 2011**Introduction to Marketing, 3 semester hours, 45 lec. (Offered as needed)**

An introductory course in the field of marketing including a look at marketing as it exists in our economy today. Consideration of the market, the product, distribution channels. Special emphasis on the study of human behavior in marketing promotion.

MAS 2103**Linear Algebra, 3 semester hours, 45 lec. (Spring, or as needed)**

Designed for mathematics and engineering majors. Prerequisite: MAC 1411 with a grade of "C" or better, or equivalent.

MAT 1024A***College Preparatory Algebra, 3 semester hours, 30 lec., 45 lab. (Fall, Spring, Summer)**

This course is designed for students whose entry level placement test scores do not meet requirements for degree credit (does not meet graduation requirements). Course may be repeated by students not fulfilling competency requirements. (By State Board of Education Rules, students are limited to three registrations in this course). Topics include operations with real number properties, linear equations and inequalities and factorization.

MAT 2905**Tutorial-Mathematics, 1 semester hour, 30 lab. (Fall, Spring, Summer)**

An experience in individual depth study in which one student prepares for and engages in tutoring another for two class periods per week. Prerequisite: Completion of course in which tutoring with a grade of "B" or better, or equivalent.



THESE STUDENTS in an economics class pay close attention to another student's report. Any one of them may be next.

MAT 2940**Directed Work Study-Mathematics, 1 semester hour, 60 lab. (Fall, Spring, Summer)**

Directed experience in instructional, laboratory and/or materials assistance in a designated Mathematics area. Prerequisite: Completion of MAC 1140 with a grade of "C" or better, or equivalent.

MCB 2013C**Microbiology, 4 semester hours, 30 lec., 60 lab. (Fall, Spring, Summer)**

A fundamental course in microbiology designed to fulfill the needs of pre-med., nursing and pharmacy students as well as science majors. A general survey of microbiology, the cultivation and observation of micro-organism and their chemical and biological relationships to water, food, industrial processes and disease. Prerequisites: BOT 1010C, ZOO 1010C, and CHM 1045 (May be taken concurrently) or permission of the instructor.

MET 1010**Introduction to Meteorology, 3 semester hours, 45 lec., (Fall, Spring)**

Structure of the atmosphere, weather processes, systems and phenomena; climate and climatic change, economic impact of weather.

MGF 2118**Quantitative Skills Seminar, 1 semester hour, 15 lec. (Fall, Spring, Summer)**

A short course dealing with mathematical skills needed for successful completion of coursework in a variety of disciplines. Prerequisite: Completion of a general education mathematics course.

MGF 2202**Finite Mathematics, 3 semester hours, 45 lec. (Fall, Spring, Summer)**

This course is designed to provide the essential mathematical skills necessary for a student entering his/her junior year of college. It includes arithmetic, geometry and measurement algebra, statistics (including probability), logical reasoning, and computing technology. Prerequisite: Completion of MAC 1102 or higher mathematics course with a grade of "C" or better, or equivalent.

MKA 2021**Salesmanship, 3 semester hours, 45 lec. (Offered as needed)**

Selling, correct attitudes and personal attributes for dealing with the public on a business or professional basis.

MKA 2041**Retail Management, 3 semester hours, 45 lec. (Offered as needed)**

Retail store management, location, buying merchandise, control policies, services, pricing, expenses, profits: training and supervision of retail sales forces, administrative problems. Also includes a variety of current perspectives in retailing management.

MKA 2511**Introduction to Advertising, 3 semester hours, 45 lec. (Offered as needed)**

Advertising as a marketing tool, its planning, creation, and use. A survey of copy writing, layout, and media (newspapers, magazines, radio, television, films, etc.)

MKA 2930**Marketing Seminar I, 2 semester hours, 15 lec. (Offered as needed)**

One class hour per week discussing resume writing and employment interviewing skills. A minimum of twelve hours per week of on-the-job experience to be arranged. Open to all students.

* College preparatory credits may not be counted towards fulfilling the number of credits required for a degree.

MKA 2931**Marketing Seminar II, 2 semester hours, 15 lec. (Offered as needed)**

One class hour per week discussing marketing research. A minimum of twelve hours per week of on-the-job experience to be arranged. Open to all students. No prerequisite.

MKA 2932**Marketing Seminar III, 2 semester hours, 15 lec. (Offered as needed)**

One class hour per week discussion marketing problems and solutions. A minimum of twelve hours per week of on-the-job experience to be arranged. Open to all students. No prerequisite.

MNA 2100**Human Relations, 3 semester hours, 45 lec. (Fall, Spring, Summer)**

Designed to help students develop an understanding of how they may be motivated to work together in greater harmony in all kinds of organizations. The basis of human motivation and how it is influenced by leadership, the organization itself, and the social environment in which the organization exists.

MTB 1103**Business Mathematics, 3 semester hour, 45 lec. (Fall, Spring, Summer)**

Presents basic principles used to solve every day business problems, including a review of basic skills and business terminology. Topics in the course include: base, rate and percentage; trade and cash discounts, wage and salary administration; insurance (fire and automobile); depreciation and business profits; distribution of corporate dividends; simple interest and bank discount and buying and selling of corporation bonds and stocks.

MUE 1905**Independent Study-Music, 1 semester hour**

A defined independent study which is pursued under supervision of a faculty directing teacher and recorded through departmental procedures. Designed to permit a student to pursue non-scheduled academic and laboratory work which may be of a specialized or advanced nature and not available through classes or courses available on a college schedule. Departmental approval required.

MUH 1011**Humanities-Music, 3 semester hours, 45 lec. (Offered as needed)**

Designed to develop a more intelligent understanding and appreciation of music. Brings about an awareness of music as a vital source in human life, including the advantageous utilization of leisure time and developing positive attitudes toward culture and the fine arts.

MUN 1100**OWCC Band (Community), 1 semester hour, 30 lab. (Offered as needed)**

A music organization providing an outlet and learning experience for both college students and wind or percussion players to read and perform standard band literature, transcriptions and program selections. Required of all wind or percussion music majors and minors. May be repeated four times for credit. Prerequisite: Ability to read music and play a band instrument; audition by Director or 1 year experience in a high school advanced band.

MUN 1310**OWCC Chorus, 1 semester hour, 30 lab. (Offered as needed)**

A music organization open through auditions to any student having experience in reading music. A variety of musical styles will be studied and performed. Students elective OWCC Chorus will be expected to participate in scheduled performances. MUN 1310 may be repeated three times for credit. Prerequisite: Experience in high school, church, or community chorus or choirs.

MUN 1340**OWCC Show Choir I, 1 semester hour, 30 lab. (Offered as needed)**

A study of the fundamental techniques and principles of integrating dance, voice, music and acting into a performance show choir. Training in voice, jazz movement, character interpretation and personality presentation is covered. Membership is open to all part-time or full-time students on a credit or audit basis. All music majors and performance majors must participate. The show choir appears in public performances at frequent intervals throughout the year. Prerequisite: Audition, consent of Department, music or performance minor.

MUN 1341**OWCC Show Choir II, 1 semester hour, 30 lab.**

A study of the fundamental techniques and principles of integrating dance, voice, music and acting into a performance show choir. Training in voice, jazz movement, character interpretation and personality presentation is covered. Membership is open to all part-time or full-time students on a credit or audit basis. All music majors and performance majors must participate. The show choir appears in public performances at frequent intervals throughout the year. Prerequisite: Show Choir I.

MUN 1710**Rock and Jazz Ensembles I, 1 semester hour, 30 lab.**

Music performing organization open to any student who wants to develop his or her performance repertoire. Laboratory studies include techniques of performing music, literature, practices, styles and media applicable to designated organized ensemble. May be repeated three times for credit. Prerequisite: Some experience in high school bands, etc.

MUN 1720**Rock and Jazz Ensembles II, 1 semester hour, 30 lab.**

Music performing organization open to any student who wants to develop his/her performance repertoire. Laboratory studies include techniques of performing music, literature, practices, styles and media applicable to designated organized ensemble. May be repeated three times for credit. Prerequisite: Some experience in high school bands, etc.



SOCIAL SCIENCE Department Chair, Dr. Joe Matthews, bottom, and his staff.

MUN 2200**OWCC Band (Community), 1 semester hour, 30 lab. (Offered as needed)**

A music organization providing an outlet and learning experience for both college students and wind or percussion players to read and perform standard band literature, transcriptions and program selections. Required of all wind or percussion music majors and minors. May be repeated four times for credit. Prerequisite: MUN 1100.

MUN 2340**OWCC Show Choir III, 1 semester hour, 30 lab. (Offered as needed)**

A study of the fundamental techniques and principles of integrating dance, voice, music and acting into a performance show choir. Training in voice, jazz movement, character interpretation and personality presentation is covered. Membership is open to all part-time or full-time students on a credit or audit basis. All music majors and performance majors must participate. The show choir appears in public performances at frequent intervals throughout the year. Prerequisite: Show Choir II.

MUN 2341**OWCC Show Choir IV, 1 semester hour, 30 lab.**

A study of the fundamental techniques and principles of integrating dance, voice, music and acting into a performance show choir. Training in voice, jazz movement, character interpretation and personality presentation is covered. Membership is open to all part-time or full-time students on a credit or audit basis. All music majors and performance majors must participate. The show choir appears in public performances at frequent intervals throughout the year. Prerequisite: Show Choir III.

MUT 1001**Fundamentals of Music, 3 semester hours, 45 lec. (Offered as needed)**

A pre-theory course for the non-music major, or for the aspiring elementary education major. Included are the studies of reading clefs, rhythm, notation, scales, and doing simple keyboard and sight-singing exercises. The emphasis is on developing music reading skills.

MUT 1121**Music Theory I, 3 semester hours, 30 lec., 15 lab. (Offered as needed)**

A study of the fundamentals of basic musicianship, music notation, understanding of simple rhythms, key situations, intervals, ear training, dictation, sightsinging, major and minor scales, intervals, triads, chords, polyphonic composition and elementary keyboard work. Prerequisite: Students wishing to take Music Theory I should have a strong background in music (high school chorus, bands, etc.).

*A non-traditional career?***MUT 1122****Music Theory II, 3 semester hours, 30 lec., 15 lab. (Offered as needed)**

A continuation of Music Theory I, MUT 1121. Basic musicianship, writing and reading of music, ear training, dictation, sightsinging will be studied, as well as major and minor scales, intervals, triads, seventh chords, inversions, cadences, periods and progressions in all keys. Two, three and four part chords and polyphonic composition. Prerequisite: Music Theory I.

MUT 2126**Music Theory III, 3 semester hours, 45 lec. (Offered as needed)**

A continuation of Music Theory I and II, MUT 1121 and MUT 1122. The harmonization and modulation of melodies through the use of nondominant harmony and the study of sequence writing. Incorporates keyboard harmony plus sight reading of chromatic melodies, large intervals, and advanced rhythms. Prerequisites: Music Theory I/Music Theory II.

MUT 2127**Music Theory IV, 3 semester hours, 45 lec. (Offered as needed)**

The continued study of harmonization of melodies, sequence writing, sight reading, intervals, advanced rhythms and structures. Prerequisites: MUT 1121, 1122, 2126.

MVB 1210 Applied Music Secondary-Brass, 1 semester hour, 7.5 lab. (Offered as needed)

Private instruction: 1/2 hour private lesson per week. Minimum one hour daily practice. For non-music majors and music majors. Course may be repeated four (4) times for credit. Prerequisite: Private instruction or high school experience.

MVB 2210**Applied Music Secondary-Brass II, 1 semester hour, 7.5 lab. (Offered as needed)**

Private instruction: 1/2 hour private lesson per week. Minimum one hour daily practice. For non-music majors and music majors. Course may be repeated four (4) times for credit. Prerequisite: MVB 1210.

MVJ 2120**Introduction to Jazz Theory/Arranging, 3 semester hours, 45 lec. (Offered as needed)**

A lecture-demonstration-workshop approach to jazz-pop arranging. Studies include jazz/pop harmonies, arranging fundamentals and techniques, and the use of jazz/pop instrumentation. Workshop practices include assigned arrangements with the arrangements played by the jazz ensemble, and other audio demonstrations. Prerequisite: MUT I and II or permission of instructor.

MVK 1211**Applied Music-Piano I, 1 semester hour, 16 lab. (Offered as needed)**

Private instruction in piano, as secondary instrument, consisting of one-half-hour lesson per week. Course may be repeated once — credit available for both.

MVK 2221**Applied Music-Piano II, 1 semester hour, 16 lab. (Offered as needed)**

Private instruction in piano, as a secondary instrument, consisting of one half-hour lesson per week. Course may be repeated once — credit available for both.

MVP 1210**Applied Music Secondary-Percussion, 1 semester hour, 7.5 lab. (Offered as needed)**

Private instruction in percussion instruments to develop the student's performance ability in an applied area. One-half hour private lesson per week. Minimum of one hour daily practice. Course may be repeated four (4) times for credit.

MVP 2220**Applied Music Secondary-Percussion II, 1 semester hour, 7.5 lab. (Offered as needed)**

Private instruction in percussion instruments to develop the student's performance ability in an applied area. One-half hour private lesson per week. Minimum of one hour daily practice. Course may be repeated four (4) times for credit. Prerequisite: MVP 1210.

MVS 1210**Applied Music Secondary-Strings, 1 semester hour, 7.5 lab. (Offered as needed)**

Private instruction: one half-hour private lesson per week. Minimum one hour daily practice. For non-music majors and music majors. Course may be repeated four (4) times for credit.

MVS 2220**Applied Music Secondary-Strings II, 1 semester hour, 7.5 lab. (Offered as needed)**

Private instruction: one half-hour private lesson per week. Minimum one hour daily practice. For non-music majors and music majors. Course may be repeated four (4) times for credit.

MVV 1211**Applied Music-Voice I, 1 semester hour, 16 lab. (Offered as needed)**

Private instruction in voice, as a secondary instrument, consisting of one half-hour session per week, with a minimum of one hour daily practice. Course may be repeated once — credit available for both.

MVV 2221**Applied Music-Voice II, 1 semester hour, 16 lab. (Offered as needed)**

Private instruction in voice, as a secondary instrument, consisting of one half-hour lesson per week, with a minimum of one hour daily practice. Course may be repeated once — credit available for both.

MVW 1210**Applied Music Secondary-Woodwinds, 1 semester hour, 7.5 lab. (Offered as needed)**

Private instruction: one half-hour private lesson per week. Minimum one hour daily practice. For non-music majors and music majors. Course may be repeated four (4) times for credit.

MVW 2220**Applied Music Secondary-Woodwinds II, 1 semester hour, 7.5 lab. (Offered as needed)**

Private instruction: one half-hour private lesson per week. Minimum one hour daily practice. For non-music majors and music majors. Course may be repeated four (4) times for credit. Prerequisite: MVW 1210.

OCE 1005**Introduction to Oceanography, 3 semester hours, 45 lec. (Fall, Spring)**

A survey of the geography, chemistry, physics, and geology of the oceans. Lectures, demonstrations, and laboratory-type exercises to acquaint the students with oceanographic operations and data. No prerequisite.

OST 1100**Typewriting I, 2 semester hours, 15 lec., 45 lab. (Fall, Spring, Summer)**

Development of correct typewriting techniques, learning the keyboard, problem typing including letters, reports and manuscripts.

OST 1110**Intermediate Typewriting, 2 semester hours, 15 lec., 45 lab., (Fall, Spring)**

Production typing, tabulation, business letter writing, reports, and manuscript typing. Prerequisite: Typewriting I or acceptable level of competency.

OST 1141**Keyboarding, 1 semester hour, 30 lab. (Offered as needed)**

A basic course in keyboarding using the touch system. The proper techniques for keyboarding alphabetic and numeric data will be emphasized.

OST 1211**Basic Shorthand, 3 semester hours, 30 lec., 45 lab. (Fall, Spring)**

Basic skills and vocabulary of shorthand. Beginning of dictation and transcription.

OST 1212**Intermediate Shorthand, 3 semester hours, 30 lec., 45 lab. (Fall, Spring, Summer)**

Speed-building in taking dictation and transcription. Prerequisite: Dictation experience or permission of the instructor.

OST 1351**Records Management, 3 semester hours, 45 lec. (Fall, Spring, Summer)**

Methods and systems of records management used in business offices, materials and equipment, and time-and-motion saving skills. Practice sets are used.

OST 1601**Machine Transcription, 3 semester hours, 30 lec., 45 lab. (Offered as needed)**

Operation of recorders and transcribers to develop transcription skills in English grammar, punctuation, sentence structure, and vocabulary. Advanced problems in producing and handling typewritten documents of all kinds. Letters with variations, real estate, medical, legal, and general correspondence. Prerequisite: Typing I or equivalent.

OST 2120**Advanced Typewriting, 2 semester hours, 15 lec., 45 lab. (Offered as needed)**

Development of occupational proficiency in production typing of business, government, legal, and medical materials. Prerequisite: Intermediate Typewriting or equivalent.

OST 2213**Advanced Shorthand, 3 semester hours, 30 lec., 45 lab. (Offered as needed)**

Mailability of transcribed shorthand notes. Accuracy of transcripts, speed in dictation, office routines. Prerequisite: Intermediate Shorthand or permission of instructor.

OST 2335**Business Communication, 3 semester hours, 45 contact hours, 3 lec.**

Business Communications is a comprehensive coverage of language structure and particular emphasis on writing superior business letters and reports. Instruction in principle, then illustration, and practice in applying the principles. A fundamental concept of the appearance, language and style, tone and psychology of effective business letters. Prerequisites: ENC 1101 or equivalent.

OST 2401**Clerical Office Practices, 3 semester hours, 30 lec., 30 lab. (Offered as needed)**

Study of practices and procedures in the modern office. Emphasis on exercising judgment, handling incoming calls and callers, processing mail, word processing systems, editing and composing techniques, travel arrangements, banking procedures, employment applications and resumes. Prerequisite: OST 1110, OST 2335 or equivalent.

OST 2402**Secretarial Office Management, 3 semester hours, 30 lec., 30 lab. (Offered as needed)**

Emphasis is placed on the primary duties of professional secretaries, including essential nontechnical skills such as decision making, the exercise of initiative, follow-through, working with people, solving office related problems, and effective management of time and materials. Prerequisite: OST 1110, OST 1210 and OST 2335.

OST 2721**Word Processing Software I, 3 semester hours, 30 lec., 30 lab. (Offered as needed)**

A basic course in Microcomputers with revisions and variables. Emphasis on gaining machine proficiency in elementary applications. Prerequisite: OST 1110.

OST 2722**Word Processing Software II, 3 semester hours, 30 lec., 30 lab. (Offered as needed)**

An advanced course in using microcomputers. Complex problems with extensive revisions; medical, legal, government, and real estate documents are emphasized. Prerequisite: OST 2721.

PCB 2011**Cell Biology, 4 semester hours, 45 lec., 45 lab. (Fall, Spring, Summer)**

A study of the cell as the basic unit of organic structure and function with the emphasis on understanding the complexity and versatility of the cell and its activities. Prerequisite: One year of high school chemistry or CHM 1020, Chemical Science.

PEL 1111**Beginning Bowling, * 1 semester hour, 30 lab (Offered as needed)**

The development of skills and practice in the basic fundamentals of bowling.

PEL 1121**Beginning Golf, * 1 semester hour, 30 lab. (Offered as needed)**

Instruction in the fundamental technique and the development or personal skills through participation.

PEL 1211**Slow Pitch Softball, * 1 semester hour, 30 lab. (Offered as needed)**

Instruction in the basic skills for full participation and enjoyment of the game of softball.

PEL 1321**Volleyball, * 1 semester hour, 30 lab. (Offered as needed)**

Instruction and practice in the basic skills for full participation and enjoyment of the game of volleyball.

PEL 1341**Beginning Tennis, * 1 semester hour, 30 lab. (Offered as needed)**

The history of tennis, the fundamental techniques and the development of personal skills through participation.

PEL 1342**Intermediate Tennis, * 1 semester hour, 15 lec., 15 lab. (Offered as needed)**

Instruction, practice, refinement of fundamental techniques; continued development of physical skills through class participation. Prerequisite: PEL 1341 or instructor permission.

PEL 1344**Advanced Tennis, * 1 semester hour, 30 lab. (Offered as needed)**

Instruction, practice, and participation in advanced tennis. The continuous development of physical skills is of major importance in this course. Instructor permission only. May be repeated for a maximum of four credits.

PEL 1346**Beginning Badminton, * 1 semester hour, 30 lab. (Fall, Spring, Summer)**

Instruction and practice in the basic skills for full participation and enjoyment of the game of badminton.

PEL 1441**Beginning Racquetball, * 1 semester hour, 30 lab. (Offered as needed)**

Instruction and participation in the skills necessary for satisfactory competition in the sport of racquetball.

PEL 1511**Soccer, * 1 semester hour, 30 lab. (Fall)**

Introduction in the fundamental techniques and the development of personal skills through participation.

PEL 1514**Advanced Soccer, * 1 semester hour, 30 lab. (Offered as needed)**

Instructor, practice, and participation in advanced soccer. The continuous development of physical skills is of major importance in this course. Instructor permission only. May be repeated for a maximum of four credits.

PEL 1621**Basketball, * 1 semester hour, 30 lab. (Fall, Spring)**

Instruction and participation in the fundamental aspects of basketball with emphasis on both the mental and motor skill developments.

PEL 1905**Independent Study-Physical Education, * 1 semester hour, 30 lab. (Fall, Spring, Summer)**

Directed study and/or individual projects designed to meet the needs and interests of students in a specialized area of health, physical education and recreation, for which present course availability is limited.

PEL 2122**Intermediate Golf, * 1 semester hour, 30 lab. (Offered as needed)**

Designed for those students who wish to improve their knowledge of golf and golf skills beyond the beginner's level.

PEL 2442**Intermediate Racquetball, * 1 semester hour, 30 lab. (Offered as needed)**

A continuation of skills learned in beginning racquetball with emphasis on more advanced skills and techniques. Particular emphasis is placed on the strategy of the game. Prerequisites: PEL 1441 or permission of instructor.

PEL 2905**Directed Work Study-Physical Education, 1 semester hour, 45 lab. (Offered as needed)**

Directed experience in instructional, laboratory and/or materials assistance in a designated Physical Education area. Entry by permission of department chair only.

PEM 1101**Modern Fitness, * 2 semester hours, 60 lab. (Fall, Spring)**

Instruction in the concepts of and practice in exercise techniques geared primarily toward muscle strength, endurance and flexibility.

PEM 1110**Fitness Concepts, 1 semester hour, 15 lec., 15 lab. (Offered as needed)**

Instruction in the concepts of fitness as related to physical and health components.

PEM 1140**Basic Aerobics, * 1 semester hour, 30 lab. (Offered as needed)**

Instruction and participation in an aerobics program.

*Activity course fulfills the Physical Education requirement.

PEM 1141

Aerobics I, * 2 semester hours, 60 lab. (Fall, Spring)
Introductory course in Aerobics with emphasis on diagnostic testing, participation in a safe aerobic program, evaluation of progress, and a study of the concepts involved.

PEM 1142

Aerobics II, * 2 semester hours, 60 lab. (Fall, Spring)
A continuation of Aerobics I, students will train using a point system with appropriate evaluation of progress.
Prerequisite: PEM 1141 or departmental approval.

PEM 1171

Aerobic Dance, * 1 semester hour, 30 lab. (Offered as needed)
Instruction and participation in a physical fitness program that offers conditioning of the figure muscles and of the cardiovascular system through dance activities.

PEM 1330

Orienteering, * 1 semester hour, 30 lab. (Offered as needed)
Development of skills needed to navigate through an unknown area using a map and compass as a guide.

PEM 2013

Tutorial: Education and Physical Education, 1 semester hour, 30 lab. (Fall, Spring, Summer)
An experience in individual depth study in which one student prepares for and engages in tutoring another for two class periods per week.

PEM 2101

Fitness-Practice/Theory, * 2 semester hours, 15 lec., 30 lab. (Offered as needed)
Instruction in the practice and theory of physical fitness flexibility, strength, muscle endurance, and cardiorespiratory endurance.

PEM 2108

Fitness Lab, * 1 semester hour, 30 lab. (Offered as needed)
Instruction and participation in an exercise program with emphasis on muscle endurance, strength and flexibility. May be repeated four (4) times.

PEM 2172

Aerobic Dance II, * 1 semester hour, 30 lab. (Offered as needed)
Advanced level of instruction and participation in a physical fitness program that offers conditioning of the figure muscles and of the cardiovascular system through dance activities. Prerequisite: Aerobic Dance I.

PEN 1251

Basic Canoeing, * 1 semester hour, 30 lab. (Summer)
This course is designed to develop safety and fundamental skills in the use of canoes.

PET 1020

Introduction to Physical Education, 3 semester hours, 45 lec. (Fall, Spring)
Instruction in the history, principles and basic concepts and foundations of the total physical education program.

PGY 1101C**

Basic Photography, 2 semester hours, 25 lec., 30 lab. (Offered as needed)
An elective course for students of graphics/printing program, and others having vocational, avocational, hobby or fine arts interests in photography. Course content will cover fundamentals, basic principles, film processing/developing, picture composition, lighting, exposure, special techniques, and mounting of prints. Camera, enlarger, light meter, flood lights and other photographic equipment will be covered.

PHI 2010

Humanities-Philosophy, 3 semester hours, 45 lec. (Offered as needed)

Central concepts of philosophy are developed, including a description of the main philosophical problems involved through ancient, medieval, and contemporary thought.

PHY 1020

Physical Science, 4 semester hours, 60 lec. (Fall, Spring, Summer)

A one-semester course of lectures and demonstrations designed (1) to meet the general education requirement in physical science for nonscience majors and (2) for students who need a preparatory course prior to taking physics. The course presents the fundamental classic and modern concepts of physics in the areas of mechanics, energy, wave motion, electromagnetism, and atomic structure.

PHY 1053C

Physics I, 4 semester hours, 45 lec., 45 lab. (Offered as needed)

The first half of a two-semester sequence of non-calculus physics designed for the non-physical science major. Physics I covers the areas of mechanics, mechanical energy, temperature and heat. The entering student is assumed to have a working knowledge of basic algebra and trigonometric functions.

PHY 1054C

Physics II, 4 semester hours, 45 lec., 45 lab. (Offered as needed)

The second half of a two-semester sequence of non-calculus physics designed for the non-physical science major. Physics II covers the areas of electricity, magnetism, light, quantum theory, atomic and nuclear structure, and elementary nuclear processes. Prerequisite: PHY 1053C or permission of the instructor.

PHY 2048C

College Physics I, 4 semester hours, 45 lec., 45 lab. (Offered as needed)

The first half of a two-semester sequence designed for majors in engineering, math and the physical sciences. Physics I covers the areas of mechanics, mechanical energy, heat, thermodynamics, and mechanical waves. Calculus is used when feasible. Prerequisite: MAC 1411.

PHY 2049C

College Physics II, 4 semester hours, 45 lec., 45 lab. (Spring, or as needed)

The second semester of a two-semester sequence designed for majors in engineering, math and the physical sciences. Physics II covers the areas of electricity, magnetism and optics. Calculus is used where feasible. Prerequisite: PHY 2048C or permission of instructor.

PLA 1460

Bankruptcy Law, 3 semester hours (Offered as needed)
An introduction into the purpose of Bankruptcy laws and the basis and structure of the Bankruptcy laws.

PLA 1803

Family Law, 3 semester hours (Offered as needed)
Study of the law relating to family and marriage and the role of the attorney.

*Activity course fulfills the Physical Education requirement.

**Occupational course that may not be applied toward the A.A. Degree.

PMT 1106***Welding I, 3 semester hours, 15 lec., 45 lab. (Offered as needed)**

An introduction course including an overview of welding as an occupation, welding terminologies, fundamentals of shielded metal arc welding, and oxyacetylene welding and cutting. Practical experience will be gained in shielded metal arc welding and oxyacetylene welding and cutting.

PMT 1111***Oxy-Fuel Welding, 6 semester hours, 30 lec., 150 lab. (Offered as needed)**

A course in the fundamentals of gas welding including: welding terminologies, oxyacetylene welding and cutting procedures. Practical experience will be gained in oxyacetylene welding of various joints configurations in the flat, horizontal, vertical and overhead positions. Extensive use of the oxyacetylene cutting process is an integral aspect of this course.

PMT 1112***Advanced Oxy-Fuel Welding, 6 semester hours, 30 lec., 150 lab. (Offered as needed)**

An advanced gas welding and cutting course including: fusion welding in all positions, braze welding, cutting torch operation, gas welding of aluminum, stainless, stainless steel and cast measuring principles will be covered.

PMT 1121***Arc Welding I, 6 semester hours, 30 lec., 150 lab. (Offered as needed)**

A course in the fundamentals of arc welding including; the operation and set up of the arc welding machine, selection and identification of electrode classifications, and an overview of the steel making process. Practical experience will be gained in arc welding of basic joint configurations using a variety of welding electrodes.

PMT 1131***Tig Welding, 6 semester hours, 30 lec., 150 lab. (Offered as needed)**

A course in the fundamentals of Tig welding including: the set up and adjustment of the tig welding machine, selection of proper tungsten electrodes, selection of filler metals, and the use of various shielding gases. Practical experience will be gained in tig welding basic welded joints on stainless and mild carbon steel, aluminum sheet and casting, and magnesium castings.

PMT 1157***Specialty Welding, 6 semester hours, 30 lec., 150 lab. (Offered as needed)**

This course is for students in their final semester of the AS, AAS option and the Occupational Certificate welding programs. This course will cover the fundamentals of mig welding, lay-out work, fabrication, and repair type welding. The student will have the opportunity to fine tune their gas, arc, tig, and oxyacetylene cutting skills before entering the job market. This course will also cover job seeking techniques such as: application forms, resume writing, and interview procedures.

PMT 1161***Pipe Welding, 6 semester hours, 30 lec., 150 lab. (Offered as needed)**

A course in the fundamentals of pipe welding including: pipe welding terminologies, oxyacetylene welding and brazing of small diameter pipe, shielded metal arc welding of large diameter pipe. Extensive use of the oxyacetylene cutting process for pipe beveling is an integral aspect of this course.

PMT 1175***Pipe Fitting, 6 semester hours, 30 lec., 150 lab. (Offered as needed)**

A course covering the fit up and welding of all common pipe configurations such as: branches, laterals, headers, reducers and orange peel pipe caps. Extensive use of the shielded metal arc welding and the oxyacetylene cutting processes are an integral aspect of this course.

PMT 2122***Arc Welding II, 6 semester hours, 30 lec., 150 lab. (Offered as needed)**

An advanced arc welding course including: intensive coverage of welding symbols and blueprint reading, weld testing and inspection. Practical experience will be gained in out of position welding using a variety of arc welding electrodes.

POS 1041**American Government, 3 semester hours, 45 lec. (Fall, Spring, Summer)**

Examines government, political ideals, and institutions. Strong emphasis is placed on political thought, the origin of the American federal system, and the distribution of powers between state and national governments.

POT 1002**Introduction to Political Science, 3 semester hours, 45 lec. (Offered as needed)**

This course reviews classical ideas, political theory and institutions from a historical and comparative viewpoint. It examines the rise of the State, its organization, economic systems, the use of force, and persuasion.

PSC 2905**Independent Study-Physical Science, 1 semester hour, 45 hours. (Fall, Spring, Summer)**

Directed study and individual projects designed to meet the needs of students interested in a specialized area of the physical sciences for which present course availability is limited.

PSC 2906**Directed Work Study-Physical Science, 1 semester hour, 45 lab. (Offered as needed)**

Practical experience with use and maintenance of lab equipment and materials. Participation in support activities and organizational routines of lab courses. Entry by permission of department chair only.

PSC 2945**Tutorial-Science, 1 semester hour, 30 hrs. (Fall, Spring, summer)**

An experience in individual depth study in which one student prepares for and engages in tutoring another for two class periods per week.

PSY 2012**Psychology, 3 semester hours, 45 lec. (Fall, Spring, Summer)**

Surveys of the various fields of psychology. Understanding human behavior by studying the adaptation of the individual to the physical and social environment.

REA 1000A***College Prep Reading, 3 semester hours, 30 lec., 45 lab.**

This course is designed for students whose entry level placement test scores do not meet requirements for degree credit. Conducted in a laboratory setting, this course is designed to improve reading speed, vocabulary, comprehension, listing and study skills. Activities and materials are individualized to meet the student's specific needs as determined by diagnostic instruments. Course may be repeated by students not fulfilling competency requirements; however, State Board of Education Rules limit students to three registrations in this course.

REA 1605**Effective Study, 1 semester hour, 15 lec., 15 lab. (Offered as needed)**

Practical application of psychological principles to personal learning and study skills. Recommended for all students who feel deficient in study techniques or who otherwise wish to improve their study skills.

*Occupational course that may not be applied toward the A.A. Degree.

REA 2105**Advanced Reading, 2 semester hours, 15 lec., 3 lab. (Offered as needed)**

An individualized approach designed to improve student's reading speed, comprehension, listening skills and ability to critically analyse various types of reading material. Activities and materials are individualized to meet student's specific needs as determined by diagnostic instruments. This is an excellent course for students who wish to improve their reading skills for educational and recreational readings. Also advisable as a preparatory course prior to taking the CLAST Test for those students whose speed is inadequate.

REA 2305**Reading Skills Review, 1 semester, 15 lec. (Offered as needed)**

An individualized approach with emphasis on development of speed, comprehension, and critical analysis of various types of reading materials. Instruction presented on individual basis through lecture and/or computer assisted approach. The levels indicate that they can benefit from a review class either prior to taking the CLAST and/or for academic or recreational reading. This course does not satisfy the college prep requirement for students who do not pass the reading subtest of ASSET or other entry level tests.

REE 1040A**Introduction to Real Estate: Course I, 4 semester hours, 63 lec. (Fall, Spring, Summer)**

This course is intended to provide the prospective licensee with the fundamental knowledge in the field of real estate principles and practices and real estate law. This is the required course prescribed by the Florida Real Estate Commission for a person desiring to become registered as a real estate salesperson.

REE 1200**Real Estate Finance, 3 semester hours, 45 lec. (Offered as needed)**

Designed to explore in detail the many facets of real estate financing with emphasis given to legal aspects, sources of funds, methodologies or major lending institutions, and the effects of high interest rates.

REE 2300**Real Estate Law, 3 semester hours, 45 lec. (Offered as needed)**

Designed to assist the student to become a more knowledgeable, and potentially, a more successful investor. Emphasis will be given to basic investment fundamentals, income tax consideration, ownership forms for investment, financing the investment and analyzing property investment returns.

REE 2430**Real Estate Law, 3 semester hours, 45 lec. (Offered as needed)**

A study and analysis of real estate law including specific aspects of Florida Real Estate Law as applied to real estate documents, their form and contents, mechanics of their use, and an exposition of modern real estate transactions.

REL 2300**Humanities-Comparative Religion, 3 semester hours, 45 lec. (Offered as needed)**

Principal religions of the world are compared and contrasted. Christianity is examined in its historical and contemporary forms.

SLS 1101**College Opportunities Management Planning & Academic Skills Seminar (COMPASS), 1 semester hour, 10 lec., 20 lab. (Offered as needed)**

A seminar designed to orientate entering students to OWCC, to familiarize them with the requirements of the College-level Academic Skills Program, to assist them in assessing their academic competencies (i.e., identify strengths and weaknesses), to identify means for capitalizing on strengths and for overcoming weaknesses, and to enter and pursue academic specializations (majors) based on reasonable career choices. This course is required for all entering, full-time, A.A. Degree seeking students in their first semester. Part-time students must take this course in the semester they are enrolled in their twelfth credit.

SLS 1301**Career and Life Planning, 1 semester hour, 15 lec., 15 lab. (Offered as needed)**

The course is designed to help students assess their values, competencies and goals in relation to the selection of careers and life-styles for which they are best suited. On a national average, two thirds of entering college freshmen have not made a choice concerning a career. Furthermore, extensive research shows that the student who has not made a career choice is much more likely to "drop-out" of college. This course will help students make an informed, realistic career choice which will form the basis for their life's work and which will also increase the probability of completing an academic program.

SPC 1600**Speech, 3 semester hours, 45 lec.**

Emphasis is on assisting the individual to develop his/her potential in oral communication. Individual participation in preparation and presentation of speeches reinforced by continuing group analysis and constructive criticism.

SPC 2520**Discussion and Debate, 3 semester hours, 10 lec., 35 lab. (Offered as needed)**

This course is designed to provide learning experiences in rational decision making incorporating the techniques of persuasion through organized procedures for argumentation. "Debate and Discussion." Prerequisite: High school speech or College speech.

SPN 1100**Spanish I, 4 semester hours, 60 lec. (Offered as needed)**

Pronunciation and grammatical structures of Spanish, with emphasis upon balanced development of all four skills - listening, speaking, reading, and writing. Covers all basic structures of the language. Students who have successfully completed two or three years of high school Spanish should enroll in Spanish III-IV.

SPN 1101**Spanish II, 4 semester hours, 60 lec. (Spring and Term II Summer)**

Pronunciation and grammatical structure of Spanish, with emphasis upon balanced development of all four skills - listening, speaking, reading, and writing. Covers all basic structures of the language. Students who have successfully completed two or three years of high school Spanish should enroll in Spanish III-IV.

SPN 2200**Spanish III, 4 semester hours, 60 lec. (Fall and Summer Term I)**

Intermediate level review of grammar, readings in Spanish literature, and development of conversational and writing skills. Prerequisite: Two or three years of high school Spanish with grade of "B" or better, or SPN 1100 and 1101 or its equivalent.

SPN 2201**Spanish IV, 4 semester hours, 60 lec. (Spring and Summer Term I)**

Completion of intermediate level review of grammar, readings in Spanish literature, and development of conversational and writing skills. Prerequisite: two or three years of high school Spanish with a grade of "B" or better, or SPN 2200 or its equivalent.

SPN 2300**Advanced Spanish Grammar and Composition I, 3 semester hours, 45 lec. (Offered as needed)**

Study of advanced grammatical structures and practice in composition. Prerequisite: SPN 2201 or its equivalent.

SPN 2301**Advanced Spanish Grammar and Composition II, 3 semester hours, 45 lec. (Offered as needed)**

Study of advanced grammatical structure and practices in composition. Prerequisite: SPN 2201 or its equivalent.

SPW 2100**Introduction to Spanish Literature I, 3 semester hours, 45 lec. (Offered as needed)**

Selected readings in modern Spanish and Spanish-American literature. Prerequisite: SPN 2201 or its equivalent.

SPW 2101**Introduction to Spanish Literature II, 3 semester hours, 45 lec. (Offered as needed)**

Selected readings in modern Spanish and Spanish-American literatures. Prerequisite: Spanish IV

STA 1014**Statistics, 3 semester hours, 45 lec. (Fall, Spring, Summer)**

Principle averages, measures of dispersion, probability distributions, sampling and sampling error, secular trend, correlation and regression and interference.

SUR 2100C**Surveying, 3 semester hours, 15 lec., 60 lab.**

Measurement of distances; elevations and angles; analysis of errors; adjustments of instruments; computation of positions, areas and volumes; contours; establishing grades; topographic mapping and land surveying.

SYG 2000**Sociology, 3 semester hours, 45 lec. (Fall, Spring, Summer)**

Concentrates on the description of individual and group behavior. Basic concepts are related to the family and the city, individual, industrial, and political problem areas.

SYG 2010**Social problems, 3 semester hours, 45 lec. (Offered as needed)**

Introduction to the sociological study of the nature of social problems to insure understanding of their impact on the individual, the group and social institutions in societal and cultural settings.

SYG 2430**The Family and Society, 3 semester hours, 45 lec. (Offered as needed)**

An examination of the problems which arise out of participation in marriage, family and community situations. Designed to provide students with a basic understanding of the dynamics of family interaction, the effects upon the children, and the family's relationship to and participation in the community.

TAX 2000**Federal Income Tax: Individual, 3 semester hours, 45 lec. (Offered as needed)**

Determine income tax liability for individuals, interpretations of Internal Revenue Code and Regulations, tax planning and advisory service. Brief introduction to partnership, corporation, estate and gift taxes. Extensive practice problems in individual income tax returns and research in tax questions.

THE 1905**Independent Study-Theatre, 1 semester hour**

A defined independent study which is pursued under supervision of a faculty directing teacher and recorded through departmental procedures. Designed to permit a student to pursue non-scheduled academic and laboratory work which may be of a specialized or advanced nature and not available through classes or courses available on a college schedule. Departmental approval required.

THE 2000**Humanities-Theatre, 3 semester hours, 45 lec. (Offered as needed)**

An introduction to theatre and theatrical production. Topics span a wide range of interest — critical, historical, aesthetic and practical — intended to lay a foundation for further knowledge and skill of the theatre.

THE 2050**Amateur Theatre, 3 semester hours, 30 lec., 30 lab. (Offered as needed)**

To establish a guideline for students of the theatre who may become active in community theatres; and for teachers in secondary schools who may be assigned the task to direct plays. This course is designed to find practical solutions to these contemporary producing groups. Prerequisites: Theatre, Acting I, and Acting II.

TTP 2110**Acting I, 3 semester hours, 30 lec., 30 lab. (Offered as needed)**

Through in-class performance the student will develop an understanding and proficiency of those skills of movement, voice, and expression which are required of a theatrical performer.

TTP 2111**Acting II, 3 semester hours, 30 lec., 30 lab. (Offered as needed)**

A continued refinement of basic acting techniques introduced in TPP 2110. Through in-class performance, the student develops an understanding and proficiency in styles of acting from classic through modern.

WOH 1012**World Civilization I, 3 semester hours, 45 lec. (Fall, Spring, Summer)**

A study of world history from 4000 BC to 1650 AD as it relates to the development of western civilization. History is analyzed in terms of social, religious, philosophical, political, and economic concepts rather than chronological facts.

WOH 1022**World Civilization II, 3 semester hours, 45 lec. (Fall, Spring, Summer)**

A study of history from 1650 AD to the present as it relates to the development of the modern world. History is analyzed in terms of social, religious, philosophical, political, and economic concepts rather than chronological facts.

WOH 2040**Twentieth Century, 3 semester hours, 45 lec. (Summer)**

International political and historical affairs in the twentieth century through the institutions and organizations of the Western State System. Attention is on international cooperation, decision making, force, world resources, and world political geography by the selection of a specific problem.

ZOO 1010C**Zoology, 4 semester hours, 45 lec., 45 lab. (Fall, Spring, Summer)**

The concepts of animal life. An introduction to the tissues in higher animals, embryology and relationships of major animal phyla to each other and to man.

Continuing Education Units

In order to provide individuals with an opportunity to meet their educational needs, Okaloosa-Walton Community College offers non-college-credit Continuing Education courses and awards one non-college-credit Continuing Education Unit (CEU) for each ten contact hours spent in these courses. These hours are organized, planned continuing education experiences under the direction and instructional control of the department in which they are offered. These courses may not be used toward any college degree.

Okaloosa-Walton offers two types of Continuing Education units as follows:

- (1) Individual units which are structured to meet the needs of targeted groups or individuals, and the content of these units are selected and organized in a sequential manner, with appropriate objectives and rationale stated in course syllabi. The courses for which individual CEU's are awarded are designated Ind. in the Course Description section of the Catalog.
- (2) Institutional units are less structured and are informal in nature, but are planned educational experiences. These units are designed to meet community needs as they arise, such as community seminars, courses on the aging, etc. No CEU units will be awarded for courses which are entertainment, social or athletic in nature. The courses for which institutional CEU's are awarded are designated Inst. in the Course Description section of the Catalog.

ACO 0101

Bookkeeping I, 60 class hours, 6 c.e.u.'s (Offered as needed)

Complete bookkeeping cycle, including journalizing, posting, preparing financial statements, and adjusting and closing the books. Procedures for proprietorships, partnerships, corporations, inventory methods, control accounts, special journals, and voucher systems, notes and drafts, depreciation and payroll methods are also included.

ACO 0102

Bookkeeping II, 60 class hours, 6 c.e.u.'s (Offered as needed)

Theory and accounting procedures for merchandising, manufacturing concerns, and the principles of cost accounting. Profit and loss analysis, comparative statements, ratios, adjustments, and various cost accounting systems. Attention to income, income tax and official Social Security tax laws, returns, and accounting procedures. Prerequisite: ACO 0101.

ACR 0949

Air Conditioning and Heating: Apprentice, 60 class hours, 6 c.e.u.'s (Fall, Spring) 24 class hours, 2.4 c.e.u.'s (Summer)

Related theory and classroom work for air conditioning and heating, apprentice training. Instruction in mathematics, blueprint reading, method of construction, safety, use of building materials, and other technical subjects.

AER 0005

Introduction to Automobile Engines, 60 class hours, 15 lec., 45 lab., 6 c.e.u.'s (Offered as needed)

This course will cover the fundamentals of diagnostics, and repairing automotive engines. Includes lecture, demonstrations, practical application activities, and performance testing. May be repeated as desired.

CJD 0606

Traffic Homicide Investigation, 40 class hours, 30 lec., 10 lab., 4 c.e.u.'s (Offered as needed)

This course meets Florida Criminal Justice Standards and Training Certification requirements for career development. Course content covers traffic homicide investigation skills to include reconstruction, forensic science, law and arrest procedures, homicide report writing.

CJD 0693

Police Intervention, 45 class hours, 4.5 c.e.u.'s (Offered as needed)

A study of the nature and causes of human stress in crisis situations involving criminal justice practitioners to include law enforcement, judicial and corrections personnel; definitions, recognition and assessment, general calming techniques, intervention; safety, abnormal behavior and suicide, role playing, causes of psychological and physiological stress agents inherent in the duties of criminal justice practitioners, and countermeasures to anxiety and stress reduction.

CJD 0934

Crime Reduction, 45 class hours, 4.5 c.e.u.'s (Offered as needed)

A course in crime prevention as it exists today in America. Study includes residential, personal and commercial crime prevention and it includes crime prevention resources, crime analysis and current legal implication. Designed primarily for in-service law enforcement officers but will not be limited to such personnel.

COC 0020N

Introduction to Computers, 45 class hours, 4.5 c.e.u.'s (Offered as needed)

An overall view of computers and how they affect each person as well as society. Hands-on experience on microcomputers provided.

EMS 0059

Initial Responder, 60 class hours, 60 lec., 6.5 c.e.u.'s (Offered as needed)

This course is designed for individuals planning careers in EMS, Fire Science, Law Enforcement, etc. who are interested in obtaining knowledge and skills necessary to provide optimum pre-hospital emergency care to the victim of trauma or sudden illness.

EMS 0119

Emergency Medical Treatment, 180 class hours, 105 lec., 30 lab., 45 hospital observation hours, 18 c.e.u.'s (Offered as needed)

Emergency Medical Treatment represents one of the early phases of training for a career in emergency medical care considered within the responsibilities of emergency medical care personnel as well as operational aspects of the job. Prerequisite: Current Standard First-Aid Care First Aid/CPR or First Responder/CPR plus passing the entry reading exam required for college level courses (see current semester class schedule for minimum scores). Students must also pass a physical exam (forms are available from the OWCC Admissions Office).

EMS 0381

EMT I Refresher, 30 class hours, 3 c.e.u.'s (Offered as needed)

Refresher Emergency Medical Treatment is part of a career structure for emergency medical technicians (EMT's). It contributes to the maintenance of uniformly high level of training and skill among EMT's. The course reviews basic skill and knowledge of emergency medical care and then brings the student up to date on new developments in the field of emergency medical treatment.

FSS 0220C

Commercial Foods and Catering, 90 class hours, 30 lec., 60 lab., 9 c.e.u.'s (Offered as needed)

An introductory course in commercial food preparation and catering. The student will develop knowledge and skill in the preparation of food, including preparations used in the food service industry. Laboratory experiences are required.

HEV 0213

Patternmaking, noncredit, 30 lec., 30 lab. hours

A course designed for students with prior experience in clothing construction who are interested in designing garments for themselves and others. Major concepts of the course include: (1) elements and principles of design and their application to fashion and (2) constructing a basic pattern (a sloper). A garment of original design will be constructed in a laboratory setting.

HEV 0216

Wardrobe Planning, noncredit, 45 lecture hours

This course provides for the development of competency in planning individual and family wardrobes. Attention will be given to the effectiveness of clothing choices in professional situations. Factors to consider in purchasing wardrobe items are stressed as well as the care, maintenance and updating of various wardrobe components. Emphasis will be placed on the psychological and social factors influencing dress and the relationship of physical appearance to clothing selection.

IEA 0131

General Education/Vocational Preparatory, 30 to 60 class hours, 3 to 6 c.e.u.'s (Offered as needed)

A special course designed to help remove basic deficiencies in English, reading, vocabulary, and basic mathematics, thus preparing an individual for advancement in employment, for entering more advanced job training, vocational, or postsecondary adult educational programs.

LLL 4602

(ESL) English as a Second Language, 45 to 90 class hours, 4.5 to 9 c.e.u.'s (Offered as needed)

Group and individual instruction in English for adults. Emphasis is placed on speaking, reading, and writing English based on living experiences and needs.

OPT 0930

Fundamentals of Optics, 8 class hours, .8 c.e.u.'s (Offered as needed)

A refresher course for professional opticians, which includes light rays, plane surfaces, spherical surfaces, thin lenses, and aberrations. Prerequisite: A suitable background in optics terminology.

PMT 0184

Welder Qualification, 15 class hours, 3 lec., 12 lab., 1.5 c.e.u.'s (Offered as needed)

A course covering an overview of welder qualifications (certification) and its importance to industry. Various welding codes will be introduced, such as: AWS, ASME, API, and Military Specifications (Mil. Specs.). The student will select one welding code on which he or she will be tested and will perform a practical welding qualification test to be evaluated by a Certified Welding Inspector Instructor. To qualify, the student's weldment must meet or exceed the test requirements specified by the selected welding code.

PUR 0920

FPRA Exam Review, noncredit, 24 lecture hours.

A review of basic knowledge required for satisfactory completion of the Florida Public Relations Association Exam.

XXX 1118A

Real Estate Law, 3 class hours, 3 c.e.u.'s (Offered as needed)

A required post-registration course for real estate salesmen and brokers to update registrant's knowledge of their legal responsibilities. Prerequisite: Real Estate License.

XXX 1119A

Residential Appraisal, 11 class hours, 1.1 c.e.u.'s (Offered as needed)

An elective course for real estate sales people and brokers to update licensee's knowledge of residential valuation principles. Prerequisite: Florida Real Estate License.

XXX 1122A

Income Capitalization Approach, 11 class hours, 1.1 c.e.u.'s (Offered as needed)

An elective course for real estate sales people and brokers to update registrant's knowledge of the income capitalization approach in real estate appraising. Prerequisite: Florida Real Estate License.

XXX 1123A

Residential Selling, 11 class hours, 1.1 c.e.u.'s (Offered as needed)

This block of instruction is designed to: (1) emphasize the responsibilities of licensees to the public in listing residential properties of sale, and (2) enhance the skills of licensees in marketing residential properties. Prerequisite: Florida Real Estate License.

XXX 1148

Programming the Computer, 45 class hours, 4.5 c.e.u.'s (Offered as needed)

An introduction to the BASIC (Beginning All Purpose Symbolic Instruction Code) programming language and flowcharting. Stresses the importance of logical and proper documentation of programs. Designed for students to use knowledge obtained as a tool in their chosen field.

XXX 1600

Beginning Shorthand I, 60 class hours, 6 c.e.u.'s (Offered as needed)

Basic skills and vocabulary of Gregg Shorthand Series 90. Beginning of dictation, transcription, and development of rapid reading and writing ability on familiar materials.

XXX 1601

Beginning Shorthand II, 60 class hours, 6 c.e.u.'s (Offered as needed)

Enlargement of vocabulary in Gregg Shorthand Series 90. Intensive dictation on familiar material and an introduction to transcription to bring the student closer to a degree of vocational skill in dictation and transcribing it in mailable form. Prerequisite: XXX 1600.

XXX 1602

Refresher Shorthand, 20 class hours, 2 c.e.u.'s (Offered as needed)

This course will assist students to enlarge their vocabularies in the Gregg Shorthand system, and increase speed and accuracy in successfully transcribing notes.

XXX 1603

Typewriting Improvement, 15 class hours, 1.5 c.e.u.'s (Offered as needed)

A course designed to review basic typing techniques and correct technique difficulties in order to acquire the minimum speed required for individual AFSC.

XXX 1606

Beginning Typewriting I, 60 class hours, 6 c.e.u.'s (Offered as needed)

Development of skills, techniques, and knowledge in the use of the typewriter for work in a business office in a clerical or stenographic position.

XXX 1609

Beginning Typewriting II, 60 class hours, 6 c.e.u.'s (Offered as needed)

Speed building through basic technique, tabulation, business letter writing, reports, and manuscript typing. Prerequisite: OST 1100 or XXX 1606 or acceptable level of competency.

XXX 1611**Programming Lab, 45 class hours.**

Hands-on application of BASIC (Beginner All Purpose Symbolic Instruction Code). Should be taken in conjunction with COC 1110 Introduction to Computer Programming.

XXX 1620**Basic Management for Supervisors, 20 class hours, 2 c.e.u.'s (Offered as needed)**

Managerial functions - planning, organizing, staffing, directing, and controlling - are analyzed, described and discussed for the edification of each student.

XXX 1663A**Course I. Real Estate Principles and Practices, 63 class hours, 6.3 c.e.u.'s (Fall, Spring, Summer)**

This course is intended to provide the prospective licensee with the fundamental knowledge in the field of real estate principles and practices and real estate law. This is the required course prescribed by the Florida Real Estate Commission for persons desiring to become licensed as real estate salesmen.

XXX 1668**Real Estate Investing, 45 class hours, 4.5 c.e.u.'s (Offered as needed)**

Designed to assist the student to become a more knowledgeable and, potentially, a more successful investor. Emphasis will be given to basic investment, fundamental income tax considerations, ownership forms for the investment, financing the investment, and analyzing and projecting investment returns.

XXX 1669**Real Estate Financing, 45 class hours, 4.5 c.e.u.'s (Offered as needed)**

Designed to explore in detail the many facets of real estate financing with emphasis given to legal aspects, sources of funds, methodologies of major lending institutions, and the effects of high interest rates.

XXX 1670**Personal Income Tax, 16-45 class hours, 16-4.5 c.e.u.'s (Fall, Spring)**

Determining income tax liability for individuals, preparation of tax returns, and interpretations of Internal Revenue code and regulations.

XXX 1902**Personnel Management, 40 class hours, 4 c.e.u.'s (Offered as needed)**

A course of instruction designed primarily for first and second level supervisors embodying coverage of principles of personnel administration as pertain to the line organization. Subjects include: classification, employment, training, labor relations, equal employment opportunity, and employee-management subject matter.

XXX 1926**Office Management, 24 class hours, 2.4 c.e.u.'s (Offered as needed)**

A course designed to provide a review and update of office management skills such as leadership, motivation, productivity, work distribution, etc., for use in office administration.

XXX 1929**Filing, 45 class hours, 4.5 c.e.u.'s (Offered as needed)**

Methods and systems of filing used in business offices, filing equipment, and time-and-motion saving skills. Filing practice sets are used.

XXX 2601**Adult Basic Education, 24 to 320 class hours, 2.4 to 32.0 c.e.u.'s (Fall, Spring, Summer)**

Basic Education for Adults with special needs for developing skills in reading, writing, and arithmetic. Especially suited for individuals seeking their G.E.D. (High School Equivalency Diploma) or individuals learning English as a second language. Prepares individuals for gainful employment or more advanced vocational and/or academic skills.

XXX 2608**Safety Education Defensive Driving, 8 class hours, .8 c.e.u.'s (Offered as needed)**

Takes into account every aspect of driving to avoid accidents regardless of conditions or actions of others.

XXX 3614**Photography, 20 class hours, 2 c.e.u.'s (Offered as needed)**

Fundamentals of photography. Exploratory experiences for the student having vocational, avocational, hobby or fine arts interest in photography. (A) Basic principles of photography, (B) film processing and developing techniques, (C) composition, lighting, mounting and special applications. May be repeated. Student should provide own camera.

XXX 4631**Everyday German, 18 class hours, 1.8 c.e.u.'s (Offered as needed)**

The course content of German sentences and phrases of high frequency use in conversation, especially in situations encountered by the traveler and resident in German-speaking community will be presented in short dramatized episodes. Skits, dialogues, sound tapes, and video tapes will be used to present the materials with minimal translation into the native language, and maximum practice in the oral control of the sentences by the students developed by dramatized practice.

XXX 6601**Educating the Consumer, 45 class hours, 4.5 c.e.u.'s (Fall and Spring)**

A study of the role of the consumer and consumer goods and services as related to the home. The course will encourage wise planning and use of resources.

XXX 6610**Advising Peers, 60 class hours, 6.0 c.e.u.'s (Offered as needed)**

A course in techniques of peer advising, focusing on communication skills, professional ethics, and knowledge of community resources for referral purposes; to be used under professional supervision in human service agencies and organizations.

XXX 6621**Child Nutrition and Health Practices, 75 class hours, 7.5 c.e.u.'s (Offered as needed)**

Methods of meeting the physical needs of young children through nutrition and good health practices. Recognition of childhood diseases and care of the handicapped child.

XXX 6624**Adjustment for Life, 45 class hours, 4.5 c.e.u.'s (Offered as needed)**

Application of psychological theory for problem solving and better mental health. A look at psychological defense mechanisms and how they may be changed into more adaptive behavior.

XXX 6625**Managing the Home I, 15 class hours, 1.5 c.e.u.'s (Offered as needed)**

Basic course in managing the home as related to individual and family activities; includes principles of positive interaction of family members as well as time and energy management applied to housekeeping tasks of providing and maintaining food, shelter, clothing, and good communication for family members.

XXX 6630**Cake Decorating, 14 class hours, 1.4 c.e.u.'s (Offered as needed)**

Designed to teach how to decorate a cake. (Self-supporting course).

XXX 6641**Non-Traditional Careers, 45 class hours, 4.5 c.e.u.'s (Fall, Spring, Summer)**

A course in which (1) participants will become aware of the special problems faced by persons in non-traditional fields with emphasis on overcoming occupational sex stereotyping and (2) participants will develop individualized career plans through the processes of realistic decision making and goal setting.

XXX 6700**Chemical Tests for Intoxication, 40 class hours, 4 c.e.u.'s (Offered as needed)**

Background and history of alcoholic; effects on motor coordination; operation and maintenance of breathalyzer equipment; court testifying; metric systems; and legal aspects of consent law.

XXX 6702**Criminal Identification, 16 class hours.**

Criminal identification techniques utilizing the Identi-Kit in building facial composites of wanted and missing persons. Development of identification — Modus Operandi file system.

XXX 6704**Police Officer Auxiliary Recruit Course, 97 class hours.**

A course designed to meet Florida Police Auxiliary officer minimum standards for certification.

XXX 6705A**Chemical Test for Intoxication-Annual Requalification Course, 8 class hours, .8 c.e.u.'s (Offered as needed)**

Course meets Florida Department of Education annual recertification of chemical tests for intoxication permits.

XXX 6709**Auto-Intoximeter Course, 8 class hours, .8 c.e.u.'s (Offered as needed)**

Auto-intoximeter operators course to include instrument familiarity and checkout. Required by State Department of Health for Intoximeter Operations. Prerequisites: State Certified Chemical Tests for Intoxication Operators.

XXX 6710**Police Radar Operator, 40 class hours, 4 c.e.u.'s (Offered as needed)**

This course is sanctioned by the Florida Police Standards and Training Commission and meets requirements of Chapter 943.14(10)(a), Florida Statutes. It is designed to equip law enforcement officers with basic knowledge and skills needed for proper operation of radar speed measurement devices.

XXX 6806**Police Skills, 45 class hours, 4.5 c.e.u.'s (Offered as needed)**

A skills development course designed to upgrade the auxiliary and/or inservice police officer in the areas of driver improvement, arrest techniques, stress reduction, medical emergencies and use of firearms. A Florida Police Standards Salary incentive course.

XXX 6807**Law Enforcement Institutes, 60 class hours, 6 c.e.u.'s; 4 or 6 hour classes, .4 Inc. c.e.u. or .6 c.e.u. (Offered as needed)**

Law Enforcement Symposiums, Seminars and Workshops offered in four or six-hour sessions, as needs dictate. A. Criminal Law (6 hours), B. Criminal Procedure (4 hours), C. Forensic Pathology (4 hours), D. Applied Technology (6 hours), E. Criminal Identification (4 hours), F. Specific Techniques (6 hours), G. Crime Scene Activities (4 hours), H. Major Felony Investigations (6 hours), K. Field Activities (6 hours), L. Evidential Issues (4 hours), M. Civil Liabilities (4-6 hours)

XXX 6851**Criminal Justice Basic Training, 327 class hours, 32.7 c.e.u.'s (Offered as needed)**

Meets the Florida Standards for Law Enforcement or Corrections certification. Student must complete 160 hours of common core courses as follows: H. Introduction to Criminal Justice (45 hours), I. Criminal Law (45 hours), G. Advanced Firearms (39 hours), P. Basic Skills (31 hours). Police candidates must complete: J. Criminal Investigation (45 hours), K. Police Operations (45 hours), L. Traffic (45 hours), S. Enforcement Skills (32 hours). Corrections candidate must complete: Q. Correctional Skills (70 hours), M. Correctional Law (45 hours), and N. Correctional Operations (45 hours).

XXX 6906**Basic Child Care and Guidance, 45 to 154 class hours, 4.5 to 15.4 c.e.u.'s (Offered as needed)**

The growth and development of the child from conception through age 5 including the physical, social, emotional, and intellectual development of the young child and the influences of environment, principles, and theories of development.

XXX 6907**Consumer and Homemaking Education, 90 class hours, 9 c.e.u.'s (Fall, Spring, Summer)**

Designed to help students improve home environment and the quality of personal and family life and includes instruction in food and nutrition, child development, clothing, housing, family relations and management of resources.

XXX 6908**Orientation to Basic Child Care, 24 class hours, 2.4 c.e.u.'s (Offered as needed)**

An introduction to child care with emphasis on children's growth and development, to be followed by Basic Child Care, XXX 6906.

XXX 6911**Introduction to Basic Clothing Construction, 45 class hours, 4.5 c.e.u.'s (Offered as needed)**

Designed to develop skills in clothing selection and construction. Emphasis on management of individual resources to meet the need of family members.

XXX 6913A**Curriculum for Young Children I, 105 class hours, 10.5 c.e.u.'s (Offered as needed)**

Study of techniques of using language arts, science, art, social studies, music, math, and physical activities with young children with emphasis on interdisciplinary learning.

XXX 6915A**Ways of Working With Young Children I, 75 class hours, 7.5 c.e.u.'s (Offered as needed)**

Course designed to increase objectivity and proficiency in observing, recording, and interpreting children's behavior; in addition, to increase awareness of patterns of behavior of children from 2 to 5 years. Includes child guidance and discipline techniques. Various assignments given as participant observes in child development centers or homes.

XXX 6916**Parent Involvement, 60 class hours, 6 c.e.u.'s (Offered as needed)**

Study of effective ways of working with parents, understanding home and community setting. Prerequisite: XXX 6913 and XXX 6915 preferable, or permission of instructor.

XXX 6917**Constructing Creative Equipment and Material, 60 class hours, 6 c.e.u.'s (Offered as needed)**

Selecting, making and using indoor and outdoor equipment and teaching materials with young children; approximately one half focusing on language development. Prerequisite: XXX 6906, XXX 6913 and XXX 6915 preferable.

XXX 6918**Child Care Services, 45 class hours, 45 lec., 4.5 c.e.u.'s (Offered as needed)**

Study of programs for young children with emphasis on the teaching roles, selection and use of equipment and materials for groups of young children.

XXX 6920**Programs for School-Age Children, 45 class hours, 4.5 c.e.u.'s (Offered as needed)**

Emphasis on programming for after-school care; includes understanding needs of school age child up to 12 years.

XXX 6922**Ways of Working with Young Children II, 90 class hours, 9 c.e.u.'s (Offered as needed)**

Study of development and application of effective skills and techniques used in programming for young children. Prerequisite: XXX 6906, XXX 6913, XXX 6915 preferable.

XXX 6923**Food Service Manager Seminar, 30 class hours, 3 c.e.u.'s (Offered as needed)**

Designed to update the food service manager in the areas of nutrition, merchandising, work simplifications, job descriptions and analysis, and human relations. Prerequisite: employment in school food service.

XXX 6925**Basic Tailoring, 75 class hours, 7.5 c.e.u.'s (Offered as needed)**

Tailoring principles, traditional and shortcut methods in fitting, construction, and finishing tailored garment. Use of wool fabric, underlining and interfacing such as hair canvas and asnaburg will be used. Advanced techniques of welt pockets, bound buttonholes, metered vent, padding stitches, and shoulder pads are also included.

XXX 6929**Decorating Your Home I, 15 class hours, 1.5 c.e.u.'s (Offered as needed)**

Basic study of home decorating principles and techniques; analyzing decorating needs and priorities; inexpensive ideas for creating individual and inviting atmosphere in the home through buying wisely or making needed items, or using existing home furnishings.

XXX 6931**Food Planning and Preparations, 30 lab., 30 lec., 60 class hours, 6 c.e.u.'s (Offered as needed)**

A basic study of foods and principles underlying meal planning, food selection, preparation and service. A consideration of the essentials of an adequate diet.

XXX 6932**Child Care Seminar, 45 class hours, 4.5 c.e.u.'s (Offered as needed)**

Weekly seminar to critique performance and plan effective student field experience. Individual and group conferences scheduled concurrently with field experience.

XXX 6935**Advanced Clothing Construction, 75 class hours, 7.5 c.e.u.'s (Offered as needed)**

Advanced problems and techniques of clothing construction and creative expression.

XXX 6938**Improving Quality of Family Life, 20 class hours, 2 c.e.u.'s (Offered as needed)**

A course which focuses on improving the quality of personal and family life through instruction in child development, family relations, budgeting and managing resources, and homemaking skills with emphasis on the dual role (home and job).

XXX 6939**Cooking with Energy Saving Appliances, 20 class hours, 2 c.e.u.'s (Offered as needed)**

The basic operation of energy saving appliances and use in cooking techniques for various foods.

XXX 7600**Auto Mechanics for the Layman, 20 class hours, 2 c.e.u.'s (Fall)**

A course designed to prepare drivers to handle simple problems relating to the automobile, including the performance of simple maintenance. (Self-Supporting)

XXX 7602**Introduction to Auto Mechanics, 20 class hours, 2 c.e.u.'s (Offered as needed)**

A course designed to make the student aware of the auto mechanics field by learning about the basic operation and the various systems of the automobile. Students will be taught to handle simple problems relating to the operation, maintenance and performance of the automobile.

XXX 7603**Occupational Orientation, 8-45 class hours, .08-4.5 c.e.u.'s (Offered as needed)**

A course in which the student will receive an orientation to the world of work and will acquire skills in choosing an occupation, applying for a job, and maintaining and progressing in an occupation.

XXX 7700**Auto Body I, 60 class hours.**

Auto body construction, basic hand and power tools, damage assessment, shop safety and procedures, human relationships. Metal straightening, shrinking sheetmetal, filling dents, pull rods, welding and cutting.

XXX 7706**Home Industries**

A course designed to prepare individuals for the manufacturing of goods in the home to be sold; training in the construction of handicraft items such as leathersgoods, ceramics, lapidary, woodworking, engraving, drawing, silk screen, and weaving. (Hours vary as to type of offering).

XXX 7708**Contractor Exam Preparation, 60 class hours, 6 c.e.u.'s (Offered as needed)**

The purpose of this course is to prepare experienced contractors to pass the exam for contractor's certification. Topics covered include math review; working drawings; specifications; estimations and take-offs; business regulations, tax laws, building codes, and safety regulations; building materials; and accounting and cost keeping.

XXX 7715

Electrical Wiring: Apprentice, 60 class hours, 6 c.e.u.'s (Fall, Spring) 24 class hours, 2.4 c.e.u.'s (Summer)

Related theory and classroom work for electrical apprenticeship training. Training in the installation of wiring systems and lighting fixtures in a building, including layout conduits, installing switch panels, pulling wire, splicing, testing circuits, line construction and performing other duties and jobs required of an electrician.

XXX 7732

Carpentry: Apprentice, 60 class hours, 6 c.e.u.'s (Fall, Spring) 24 class hours, 2.4 c.e.u.'s (Summer)

Related theory and classroom work for carpentry, apprentice training. Instruction in mathematics, blueprint reading, method of construction, safety, use of building materials, and other technical subjects.

XXX 7734

Plumbing and Pipefitting: Apprentice, 60 class hours, 6 c.e.u.'s (Fall, Spring), 24 class hours, 2.4 c.e.u.'s (Summer)

Related theory and classroom work for plumbing and pipefitting, apprentice training. Instruction in mathematics, blueprint reading, method of construction, safety, use of building materials, and other technical subjects.

XXX 7735

Sheetmetal: Apprentice, 60 class hours, 6 c.e.u.'s (Fall, Spring) 24 class hours, 2.4 c.e.u.'s (Summer)

Related theory and classroom work for sheetmetal apprentice training. Instruction in mathematics, blueprint reading, method of construction, safety, use of building materials, and other technical subjects.

XXX 7749

Basic Baking, 180 class hours, 18.0 c.e.u.'s (Offered as needed)

A study of baking practices and principles as they apply to the preparation of breads, rolls, pastries, pies, cakes, cookies, and specialty desserts.

XXX 7756

Sanitation/ Safety for Food Service Workers, 30 class hours, 15 lec., 15 lab., 3 c.e.u.'s (Offered as needed)

A course designed to develop a consciousness of safe and sanitary procedures in food serving to groups of people and to teach persons how to follow safe personal and operation habits in food service.



OUR PRINTER, Don Truitt. He can print anything.

XXX 7769

Waiter/Waitress Techniques, 20 contact hours, 10 lec., 10 lab. (Offered as needed)

A study of waiter/waitress duties. Responsibilities: station set-up, table settings, sanitation and safety, initiating guest service, meal serving, and a study of personal hygiene, appearance and attitudes.

XXX 7774

Introduction to Computer Drafting, noncredit, 5 lec., 20 lab. hours. (Offered as needed)

A course designed to help drafting students update their skills in the area of computer aided drafting. The course will include general background information on computer drafting theory as well as hands-on experience on computer drafting hardware.

XXX 7843

Communication System, 45 class hours, 4.5 c.e.u.'s (Offered as needed)

Communication systems and the factors affecting the design, operation and maintenance of receiving and transmission equipment. AC/DC theory, antennas, transistors, microwaves, oscillators and amplifiers are covered. Preparation for F.C.C. radio/telephone license examination.

XXX 7981

Water Treatment Operator, 165 class hours, 16.5 c.e.u.'s (Offered as needed)

Study of water treatment. This course will cover the operation of a water treatment plant and related mathematics, biology, chemistry, records, and reports used in the operation of a water treatment facility. This course is preparation for the state "B" level water plant operator certification. Prerequisite: Consent of instructor.

XXX 7982

Beginning Wastewater Operator I, 142 class hours, 14.2 c.e.u.'s (Offered as needed)

An introductory study of the field of wastewater treatment. This course will cover the operation of a wastewater plant and the related mathematics, biology, chemistry, laboratory records and reports used in the operation of a wastewater facility. This course is preparation of the State "B" level wastewater operator.

XXX 8609

Green Thumb, 20 class hours, 2 c.e.u.'s (Offered as needed)

"Green Thumb" is designed to make each student cognizant of the main principles of plant selection and care. (Self-Supporting course)

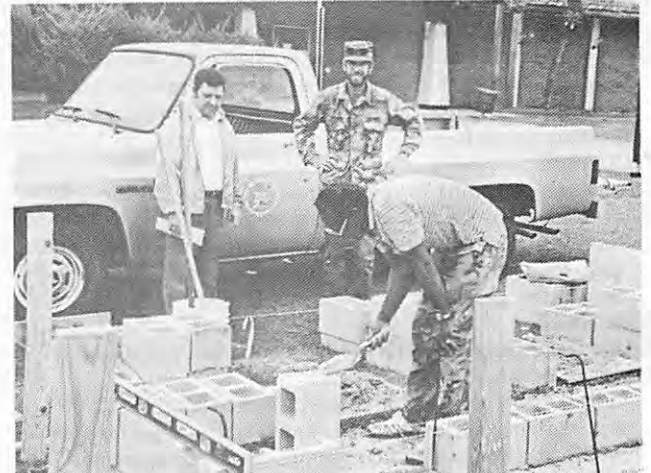

A NEW SIGN goes up in the center of the college between the College Mall and the Learning Resources Center. The sign announces coming student events.

PERSONNEL LISTING

DISTRICT BOARD OF TRUSTEES

Hilda R. Coursey, 1989, Chairman
Patrick E. Byrne, II, 1989, Vice Chairman
Eileen H. Arpke, 1990
John E. Baldwin, 1990
Elise D. Biggs, 1990
Charlie H. Hill, 1989
Jeffrey McInnis, 1991
Jean Wilkinson, 1991
Joseph D. Lorenz, Attorney for the Board

OFFICE OF THE PRESIDENT

James R. Richburg, President
A.A. — Columbus College
B.S., M.A., Ed.D. — University of Georgia
Carolyn Laux, Secretary to the President
Barbara Bishop, Secretary II
Bolley Johnson, Assistant to the President
A.A. — Pensacola Junior College
B.S. — Florida State University
James P. Chitwood, Director, OWCC Foundation
A.A. — Okaloosa-Walton Community College
B.A. — Saint Leo College
Lester S. Smith, Director of Public Information
B.S. — Texas A&M
M.S. — Boston University
Becky Tislow, Secretary II

OFFICE OF INSTRUCTIONAL SERVICES

James A. Durham, Dean of Instruction
B.S., M.S. — University of Tennessee
Ed.D. — University of Southern Mississippi
James Rhoades, Assistant to the Dean of Instruction
B.S. — Troy State Teachers College
M.S. — Florida State University
Charlotte McDonald-Williams, Secretary IV
A.S. — Okaloosa-Walton Community College
D. Annelle Marcus, Secretary II



THE DEAN OF INSTRUCTION, Dr. James R. Durham, and his staff.

DIVISION OF HUMANITIES, FINE, AND PERFORMING ARTS

Clifford Herron, Division Director/Instructor in Humanities

A.A. — Lake Michigan College
B.S., M.A. — Western Michigan University
Ph.D. — Florida State University

Mary Lou Baker, Secretary II

Arnold Hart, Instructor, Humanities and Studio Art
B.F.A., M.Ed. — University of Florida

Robert A. Larson, Instructor, Humanities, Philosophy, & Sculpture

B.S.S. — Fairfield University
M.A. — University of Florida
Ph.D. — Florida State University

John G. Leatherwood, Instructor, Humanities and Music/
Director, Chorus & Orchestra

B.M. — Mars Hill College
M.M. — George Peabody College for Teachers of
Vanderbilt University

David Owens, Instructor, Humanities and Studio Art
B.S., M.F.A. — Florida State University

Walter B. Shipley, Instructor, Humanities/Director
of Theatre

B.S. — Bethel College
M.A. — Memphis State University

J. Richard Warren, Instructor, Humanities

B.A., M.A. — Stetson University
Ph.D. — Florida State University



A TWO PIANO RECITAL, featuring selections from Mozart and Rachmaninoff was presented in the College Mall by Don Christmas and Richard Hoops.

DIVISION OF MATH AND SCIENCE

Ronald A. Head, Director/Instructor, Physical Science
 B.S. — Birmingham-Southern College
 M.A. — University of Alabama
 Ph.D. — University of the Pacific
 Carmen L. Lopez, Secretary II

Ross E. Hamilton, Instructor, Biology
 B.S. — William Carey College
 M.S. — Northeast Louisiana State University
 Lionel O. Leon, Jr., Instructor, Biology
 B.S. — University of Tampa
 M.S., Ed.D. — University of Florida
 Andrew F. Dale, Instructor, Physical Science
 B.S., M.S. — University of Minnesota
 Donald H. Kampwerth, Instructor, Physical Science
 B.S. — Bradley University
 M.S. — University of Washington
 Roswitha Zimmer, Instructor, Physical Science
 B.S. — University Regensburg, West Germany
 M.S., Ph.D. — Technical University, Munich,
 West Germany
 Karen Baker, Instructor, Mathematics
 A.A. — Chipola Junior College
 B.A., M.A. — University of West Florida
 Lewis C. Heckroth, Instructor, Mathematics
 B.A. — University of Minnesota
 M.S. — Texas A&M University
 Mary L. Henderson, Instructor, Mathematics
 B.A., M.A.T. — University of West Florida
 Shirley Howard, Instructor, Mathematics
 B.S., M.S. Texas Technological University
 Myron A. Howell, Instructor, Mathematics
 B.S.E., M.Ed. — University of Florida
 Martha C. Jordan, Instructor, Mathematics
 B.A. — Troy State Teachers College
 M.S. — Florida State University
 Mae Lynn McCardle, Instructor, Mathematics
 B.S. — Howard College
 M.A. — Samford University
 Robin Charles Olmstead, Instructor, Mathematics
 B.S., M.S.T. — Georgia Southern College
 Julia K. Polk, Instructor, Mathematics
 B.S. — Southeastern Louisiana University
 M.S. — Clemson University

DEPARTMENT OF COMMUNICATIONS

Margaret A. Crozier, Chairman/Instructor, Speech and English
 B.A., M.A. — Louisiana Technical University
 Lynne L. Ray, Secretary II (Communications and Social Science)
 Tammy S. Sutton, Office Worker

Myrtle B. Beavers, Instructor, English
 A.A. — Okaloosa-Walton Community College
 B.A., M.A. — University of West Florida
 Edwin A. Gardner, Instructor, English and Foreign Languages
 B.A. — University of Idaho
 M.A. — University of Oregon
 Dorothy P. Harris, Instructor, English and Foreign Languages/Coordinator of Learning Lab
 B.A. — North Central College
 Dolmetscher Certificate — University of Heidelberg,
 Germany
 M.A. — University of North Carolina
 Rietta Winn Howard, Instructor, English
 A.B. — Wesleyan College
 M.A. — University of North Carolina
 Sarah Paulk, Instructor, English and Humanities
 A.A. — Okaloosa-Walton Community College
 B.A., M.A., Ph.D., — Florida State University
 Cheryl C. Powell, Instructor, English
 B.A. — Auburn University
 M.A. — Florida State University
 Rebecca Sears, Instructor, English
 B.A. — Berea College
 M.A. — Eastern Kentucky University
 Lulu S. Watson, Instructor, Reading
 B.A. — University of West Florida
 M.S. — Troy State University
 C.M. Duque Wilson, Instructor, English
 B.A.E., M.Ed. — University of Florida
 Joy P. Yarnall, Instructor, English
 B.S. — University of Alabama
 M.A. — University of West Florida



GROUPED TOGETHER is the new Science and Math Division which used to be separate departments.



THE COMMUNICATIONS DEPT. meets with a member of the Florida State University Articulation Team.

DEPARTMENT OF SOCIAL SCIENCE

Joseph J. Matthews, Chairman/Instructor, Social Science
B.A., M.A. — University of Miami
Ph.D. — Kansas State University

Donald Christmas, Instructor, Social Science
B.M., M.M. — Instructor State University
M.A. — University of Houston

Edward T. Scofield, Instructor, Social Science
A.A. — Okaloosa-Walton Community College
B.A., M.A., — Eastern Washington University

Ronald Senzig, Instructor, Social Science
B.S., M.A. — Indiana State University

Mary L. Stegall, Instructor, Social Science
B.S. — Furman University
M.S., Ph.D. — University of North Carolina

DEPARTMENT OF HEALTH AND PHYSICAL EDUCATION

Lanny R. Heath, Chairman/Instructor, Health and
Physical Education
A.A. — Georgia Southwestern Junior College
B.S. — Georgia Southern College
M.A. — George Peabody College
Faye E. Golding, Secretary I
A.A.S. — Midland Technical College

Gaius Bruce, Instructor, Health and Physical Education
B.S., M.S. — Memphis State University

Charles H. Pulley, Instructor, Health and Physical
Education
B.S.R., M.P.E. — University of Florida

Louan B. Rathke, Instructor, Health and Physical
Education
B.A. — Lenoir Rhyne College
M.Ed. — University of North Carolina-Greensboro

Johnny Matthews, Office Worker

OFFICE OF VOCATIONAL/ TECHNICAL EDUCATION

David L. Goetsch, Dean of Vocational/Technical
Education

A.S. — Pensacola Junior College
B.S., M.A. — University of West Florida
M.S. — Troy State University
Ed.D. — NOVA University

Faye Crawford, Secretary III

DIVISION OF PUBLIC SAFETY

W.H. Wise, Sr., Director
B.S. — University of Maryland
M.B.A. — George Washington University
Janet Lynn Ellis, Secretary II

R.W. Bray, Instructor
B.A., M.S. — NOVA University

DEPARTMENT OF BUSINESS EDUCATION

William S. Roberts, Acting Chairman/Instructor
B.S. — Livingston State University
M.S. — University of Southern Mississippi
Monette C. Page, Secretary II

Ernest Beasley, Instructor, Economics
B.S. — High Point College
M.B.A. — University of Miami

Natalie E. Edwards, Instructor, Business Education
B.S. — Fayetteville State University
M.A. — Ohio State University

James D. Holland, Instructor, Computer Science
B.S. — Arizona State University
M.S. — University of West Florida

Edward Friese, Instructor, Distributive Education
A.A. — St. Petersburg Junior College
B.S. — University of Alabama
M.A.T. — University of Mississippi

George Lucas, Instructor, Accounting & Statistics
B.B.A., M.A. — Marshall University

Robert H. Miller, Instructor, Computer Science
B.S., M.B.A. — University of West Florida
Joel Perdue, Instructor, Data Processing

B.E.E. — University of Omaha
M.B.A. — Midwestern State University

Donna K. Utley, Instructor, Business Education
B.S. — Texas Technological University
M.S. — Texas A&M University

Dorothy Jackson, Instructor, Business Education
A.A. — Southwest Mississippi Jr. College
B.S. — University of Alabama
M.B.E. — University of Mississippi

DEPARTMENT OF INDUSTRIAL/ TECHNICAL EDUCATION

Gail C. Kaltz, Chairman/Instructor, Welding

Robert C. Atwood, Instructor, Graphic Arts
A.A. — Palomar Junior College
B.S. — San Diego State University
M.A. — Michigan State University

Wes Johnstone, Instructor, Electronics
B.S. — University of West Florida

Riley Perdue, Instructor, Food Service
Raymond L. Rickman, Instructor, Drafting/Design
A.A. — Okaloosa-Walton Community College
B.S. — University of West Florida

Ron Walls, Instructor, Electronics

DEPARTMENT OF CONTINUING EDUCATION

Marilee C. Whitney, Director
B.S., M.S. — Florida State University
Phyllis Black, Secretary II (Continuing Education & Literacy Center)
Eugenie V. Weathers, Instructor, Home Economics

LITERACY CENTER AND ADULT BASIC EDUCATION

Barbara M. Jones, Director
B.S. — Tennessee Technological University
M.A. — University of West Florida

Olivia S. Elmore, Instructor, Adult Education
A.A. — Spearfish Teachers College
B.S. — Florida State University
M.S. — University of South Alabama

Doris L. Johnson, Instructor, Adult Basic Education
B.S., M.Ed. — Florida A&M University

Dianne F. Kostelny, Instructor, Adult Studies
B.S. — Bob Jones University
M.Ed. — University of Cincinnati

OFFICE OF EVENING STUDIES

Robert D. Wilson, Dean of Evening Studies
B.S. — University of South Carolina
M.S. — U.S. Naval Postgraduate School
Ph.D. — University of Mississippi

Dot Carter, Secretary II (Evening Studies and Industrial/Technical Education)

OFFICE OF STUDENT SERVICES

AnnaBelle D. James, Director of Student Services
A.A. — Okaloosa-Walton Community College
B.A., M.A. — University of West Florida
Eve C. DiMaria, Secretary II

Dianne Faith Avillion, Counselor/Coordinator of Tracking, Tutorial, Substance Abuse Education and Aids Education Programs
B.A. Mansfield State College
M.Ed., Ed.S. — University of Florida

Inez W. Bailey, Counselor/Coordinator of Services to Students With Special Needs
B.S. — Hampton University
M.Ed. — Wayne State University

Sue T. Bridges, Counselor/Coordinator of Testing
B.S. — Eastern New Mexico University
M.Ed. — Trinity University
Ph.D. — Texas A&M University

Gordon L. Jaspersen, Coordinator of Counseling and Placement and Tours
B.S., M.S. — University of Wisconsin
Ed.S. — University of Wyoming

Jody Thomas, Counselor/Coordinator of Student Activities
B.S. — Florida International University
M.S. — Troy State University

Carolane Williams, Coordinator, Assessment Centers
A.A. — Olive-Harvey Junior College
B.A. — Chicago State University
M.S. — Troy State University

Joyce Martin, Secretary I
A.S. — Wayne Community College

Naomi Shermer, Campus Nurse
R.N. — University of Tennessee

OFFICE OF FINANCIAL AID

Christine C. Bishop, Director of Financial Aid
A.A. — Alpena Community College
B.S. — Troy State University

Janice M. Coon, Financial Aid Specialist
A.A. — Ball State University

Joan Baldwin, Fiscal Assistant
A.A. — Okaloosa-Walton Community College
B.A. — University of West Florida

Elizabeth A. Smith, Secretary II
A.S. — Okaloosa-Walton Community College

OFFICE OF ADMISSIONS AND REGISTRATION

Eugene S. Benvenuti, Registrar and Director of Admissions
B.S., M.A. — University of Southern Mississippi

Ethel Phelps, Office Manager
Lorraine Davis, Office Worker
Josette R. Horne, Clerk
Amy Rudolph Junger, Secretary II
Bobbie G. Pride, Clerk
Geraldine Nutter, Office Worker

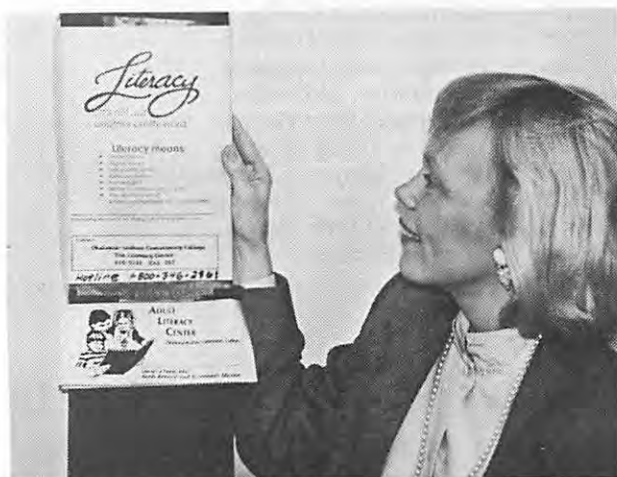

THE COLLEGE'S LITERACY CENTER, run by Barbara Jones, coordinates adult literacy classes for Okaloosa and Walton counties with objectives of reaching more people and using all adult education resources more effectively.

OFFICE OF LIBRARY SERVICES

Lucy Warren, Director of Library Services
B.A. — Duke University
M.L.S. — Florida State University
Patricia Belote, Secretary II
A.A. — Okaloosa-Walton Community College
Owen Adams, Audio Visual/Cataloging Librarian
A.A. — Gulf Coast Community College
B.A. — Our Lady of the Lake University
M.S.L.S. — Florida State University
M.B.A. — University of West Florida
Janice W. Henderson, Cataloging Librarian
B.S. — Spring Hill College
M.S.L.S. — University of North Carolina
Margaret T. Phillips, Acquisitions Librarian
A.A. — Emory-at-Oxford
B.A. — University of Alabama
M.A.L.S. — Emory University
Hosmer W. Roberson, Periodicals/Reserve Librarian
B.S. — University of Alabama
M.S. — University of Southern Mississippi
Kathleen O. Brinkley, Clerk
Diane Culver, Clerk
Pamela R. Hynes, Office Worker
B.A. — Central Michigan University
Sandra MacDonald, Office Worker
Sharron L. Stradford, Office Worker
A.A. — Chipola Junior College
B.A. — University of West Florida
Edward M. Livingston, Jr., Media Services Manager
A.A. — Okaloosa-Walton Community College
Judy Holzschuh, Secretary
Ailon Ison, Clerk

OFF-CAMPUS CENTERS

CHAUTAQUA NEIGHBORHOOD CENTER

Flora S. Conger, Director
B.S. — Drexel University
M.S. — University of North Carolina
Ed.D. — NOVA University
Charlotte A. Langley, Educational Advisor/Instructor,
Data Processing and Business Education
A.A. — Okaloosa-Walton Community College
B.S. — University of West Florida
M.S. — University of Southern Mississippi
Judy J. Metzger, Secretary II
A.A. — Okaloosa-Walton Community College
Tammy D. Lawrence, Secretary I

EGLIN CENTER

Reate Davis, Director
A.A. — Yuba College
B.G.S. — University of Nebraska at Omaha
M.S. — Troy State University
James A. Graham, Educational Advisor
A.A. — Okaloosa-Walton Community College
B.S. — University of West Florida
M.S. — Troy State University
Peggy A. Paplauskas, Secretary II
Maxine Randolph, Secretary I

OWCC-UWF FORT WALTON BEACH CENTER

Ned R. Couey, Director
B.S. — Bryan College
M.A. — University of South Florida
Ed.D. — Auburn University
John W. Stair, Educational Advisor
B.S., M.S. — Auburn University
Jeanne P. Besse, Secretary II
A.A. — Okaloosa-Walton Community College
Nancy M. DiBattista, Secretary I
B.A. — Wright State University

HURLBURT CENTER

Hilda M. Anger, Director/Instructor, Communications
A.A. — Blackburn University
B.A. — University of Indianapolis
M.A. — University of West Florida

OFFICE OF ADMINISTRATIVE AFFAIRS

Jeff Schembera, Dean of Administrative Affairs
B.S., M.S. — Florida State University
Victoria L. Keller, Assistant to the Dean of
Administrative Affairs
Stephanie Klepacki, Secretary III

BUSINESS OFFICE

Kenneth R. Burdzinski, Comptroller
B.B.A. — Eastern Michigan University
M.B.A. — Baldwin-Wallace College
Dena Gamble, Secretary II
Charles Brocketto, Accountant
Bobbie Jean Sweeney, Office Manager
Susan K. Davidson, Payroll Specialist
Theresa H. Harris, Clerk
Michelle Jones, Clerk
Elizabeth W. Kuntz, Fiscal Assistant
B.A. — University of Cincinnati
Louise (Scottie) Thacker, PBX Operator



THE DEAN OF ADMINISTRATIVE AFFAIRS, Jeff Schembera, and most of his staff.

MANAGEMENT INFORMATION SERVICES

Marty Steinberg, Director of Management Information Services
B.S. — City College of New York
Terry R. Brown, Microcomputer Coordinator
A.S. — Okaloosa-Walton Community College
Sylvia Caldwell, Programmer/Analyst
A.A. — Okaloosa-Walton Community College
B.S. — University of West Florida
James W. Campbell, Computer Operator
Donna B. Herder, Programmer/Analyst Supervisor
B.S. — University of Rhode Island
Elizabeth Morgan, Staff Assistant
Roger Noel, Office Manager
Jimmy Willis, Computer Operator

PERSONNEL DEPARTMENT

William T. Hall, Director of Personnel
B.S. — Southern Illinois University
M.S. — Virginia State University
Edna F. Washington, Secretary II
Nancy Murphy, Personnel Specialist

PURCHASING, AUXILIARY, AND CENTRAL SERVICES

N. Richard Stallworth, Director
B.S. — Louisiana State University
Geraldine Fleming, Office Specialist
Tonia E. Lawson, Secretary II
Edward C. Stevens, Bookstore Manger
Juanita Goodwin, Clerk (Bookstore)
Sybil King, Food Service Manager/Instructor
Sherry L. Brooks, Clerk (Food Service)
Annette B. Holmes, Cook
Kathy Newsome, Dishroom Worker
Christopher Polazzo, Clerk (Food Service)
Gwen J. Street, Staff Assistant — Graphic Services
Theresa A. Comeau, Typesetter (Graphic Services)
Donald L. Truitt, Printer (Graphic Services)
Donald R. Levesque, Storekeeper
Certificate — Okaloosa-Walton Community College
Steve Fielding, Office Worker
James Chessher, Office Worker

RETIRED FACULTY AND PROFESSIONAL STAFF

James Edward McCracken, Ph.D., 1964-1988,
President Emeritus
Henderson Adams, M.A., 1968-1981
Lucile Anderson, M.A., 1964-1972
Vera Craiger Auerbach, M.A., 1968-1987
*Jack Bartell, M.A., 1964-1971
Roby A. Beal, Ed.D., 1967-1988
Harold Boone, 1972-1987
Roy Bundy, Ph.D., 1968-1989
Louise Campbell, M.A., 1967-1970
Herbert J. Cash, M.S., 1968-1989
George Castle, M.A., 1972-1985
Leigh Chapman, 1969-1979
Grady Clark, 1973-1983
Jack Culwell, M.S., 1967-1987
Fanny-Fern Davis, Ph.D., 1965-1968
Dorothy Fernstrom, Ed., 1971-1986
Gerald Fowler, M.B.A., 1973-1988
John Glasgow, M.S., 1964-1987
Earl Gulledge, Ph.D., 1971-1984
Tom Hester, B.S., 1967-1985
Rosa N. Hilton, M.A., 1965-1986
Elizabeth Jones Hoefflin, M.S.L.S., 1968-1978
Chilton Jensen, M.S., 1968-1976
Cecil Johnson, M.S., 1965-1985
*James LaRoche, M.A., 1968-1983
R. D. Lawson, M.S., 1970-1985
Elizabeth Martin, M.A., 1965-1987
Maurice Mettee, 1968-1982
George Muhlbach, M.A., 1969-1984
Albert Nudo, M.M., 1968-1985
*Alfred S. Pell, B.S., 1977-1987
Fred Phillips, 1973-1981
*Laura N. Ray, M.A. L.S., 1965-1979
Ray H. Rudolph, M.B.A., 1965-1984
William T. Sadler, Ph.D., 1972-1985
Jean Sheppard, Ed.S., 1972-1989
Bernice Shuler, M.S. L.S., 1969-1984
Merrill A. Symonds, Ph.D., 1967-1984
Mamiruth Walter, M.Ed., 1964-1974
Ralph Yoder, 1968-1980

HONORARY CHAIRS

*Capp, Al
American Arts Chair — Artist-in-Residence, 1966
*Carter, Hodding
American Arts Chair — Artist-in-Residence, 1966
*Holzhauer, Emil
Honorary Chair in the Arts
Myers, Gordon
American Arts Chair — Artist-in-Residence, 1966
Schrader, Arthur
American Arts Chair — Artist-in-Residence, 1966
Sikes, Robert L. F.
Honorary Chair in Government

*deceased

PHYSICAL PLANT

Warren C. Smith, Director, Physical Plant
 A.A. — Okaloosa-Walton Community College
 B.S. — University of West Florida
 Brenda J. Patten, Secretary II
 A.A. — Okaloosa-Walton Community College
 Tom J. Barnes, Assistant Director of Physical Plant
 Ruben D. Chandler, Assistant Director of Physical Plant
 A.A. — Okaloosa-Walton Community College
 Billy H. Butler, Safety Inspector
 Murdene Baker, Senior Custodian
 Viola Banks, Custodial Worker
 Willie Bradberry, Groundskeeper
 Henry Brault, Groundskeeper
 William J. Brown, Trades Specialist
 Bobby Carr, Custodial Worker
 Colandus Chatman, Jr., Custodial Worker
 John Cobb, Custodial Worker
 Bruce Connolly, Trades Specialist
 Marty Edwards, Groundskeeper
 George Fisher, Custodial Worker
 Elbert Gore, Trades Specialist

Don Grace, Senior Groundskeeper
 Michael J. Hancock, Groundskeeping Supervisor
 Ruby Hardee, Custodial Worker
 Mattie Harris, Custodial Worker
 Jessie Jackson, Custodial Worker
 Clarence Jeter, Skilled Craftsman
 Bethel Johnson, Custodial Worker
 Jimmy E. Land, Skilled Craftsman
 Jimmy Lawson, Groundskeeper
 Philip A. Leski, Custodial Worker
 Henry C. McCaskill, Custodial Worker
 Gladys McCormick, Custodial Worker
 Chubby Moore, Custodial Worker
 Tom Morgan, Jr., Custodial Worker
 A.A. — Tallahassee Community College
 Aubrey Q. Newberry, Custodial Worker
 A.A. — Lurleen B. Wallace State Jr. College
 L. Z. Pritchett, Senior Custodian
 John R. Roberts, Skilled Craftsman
 A.A.S. — Okaloosa-Walton Community College
 Cornell Williams, Senior Custodian
 John W. Williams, Custodial Worker



THE BOOK STORE in the College Mall keeps students supplied with texts and study materials.



MARTY STEINBERG and the Management Information Systems crew.



SHIFT CHANGE. Cornell Williams, Senior Custodian (day) and Ruben Chandler, Assistant Director, Physical Plant (night) discuss work with the Physical Plant Director, Warren Smith.

LOCATION OF COURSE PREFIX BY DEPARTMENT

Course Prefix	Department
ACG	Business
ACR	Industrial
AER	Industrial
AMH	Social Science
APB	Biology
ARC	Industrial
ARH	HA Epp.-Com.
ART	HA Epp.-Com.
ATM	Industrial
BAN	Business
BCN	
BOT	Biology
BSC	Biology
BUL	Business
CCJ	Public Safety
CET	Public Safety
CGS	Business
CHD	Home Economics
CHM	Physical Science
CIS	Business
CJD	Public Safety
CJT	Public Safety
CLP	Social Science

Course Prefix	Department
CNM	Business
COA	Home Economics
COC	Business
COP	Business
CRM	Business
CRW	Com. *
CTE	Home Economics
DAA	Physical Education
DEP	Social Science
DIE	Home Economics
ECO	Business
EDF	Com. *
EDP	Social Science
EET	Industrial
EEX	Social Science
EGN	Industrial
EME	Business
EMS	Physical Education
ENG	Industrial
EME	Business
EMS	Physical Education
ENC	Com. *
ENG	Com. *
ENL	Com. *



***HISTORIC SIGNING.** This signing ceremony between Pledger Sullivan and Dr. James R. Richburg marked an historic pledge between the Bay Area Vocational School and the College which would permit Vo-Tech students to receive college credit for their vo-tech work and go on to earn a degree from the college. Sullivan is Superintendent of Schools for Okaloosa County and Richburg is president of Okaloosa-Walton Community College.*

EST	Industrial
ETD	Industrial
EGD	Industrial
ETI	Industrial
FAD	Home Economics
FFP	Public Safety
FRE	Com.*
FRW	Com.*
FSS	Industrial
GEB	Business
GER	Com.*
GSS	Social Science
GEW	Com.*
GLY	Physical Science
GRA	Industrial
HFT	Business
HHD	Home Economics
HME	Home Economics
HOE	Home Economics
HSC	Physical Education
HUM	Humanities**
HUN	Biology
IDS	Com.*
IEA	Industrial
INR	Social Science
JOU	Com.*
LEA	Public Safety
LEI	Physical Education
LIN	Business
LIS	Com.*
LIT	Com.*
MAC	Mathematics
MAE	Mathematics
MAN	Business
MAP	Mathematics
MAR	Business
MAS	Mathematics
MAT	Mathematics
MCB	Biology
MET	Physical Science

MGF	Mathematics
MKA	Business
MNA	Business
MTB	Business/Industrial
MTR	Industrial
MUH	Humanities**
MUT	Humanities**
OCE	Physical Science
OST	Business
PCB	Biology
PEL	Physical Education
PEM	Physical Education
PEN	Physical Education
PEO	Physical Education
PET	Physical Education
PHI	Humanities*
PHY	Physical Science
POS	Social Science
POT	Social Science
PSC	Physical Science
PSY	Social Science
REA	Com.*
REE	Business
REL	Com.*
SLS	Com.*
SOC	Social Science
SPC	Com.*
SPN	Com.*
SPW	COM.*
SSI	Social Science
STA	Business
SYG	Social Science
TAX	Business
THE	Com.*
TPA	Com.*
TPP	Com.*
WOH	Social Science
XXX	All departments (non-college credit)
ZOO	Biology

*Communications.

**Humanities and the Arts.



GRAPHIC SERVICES. Gwen Street, center, and her happy team who somehow manage to get everyone's printing done. Here they display some of their handiwork for the year including the 25th Anniversary booklet held by Bob Lester, right.

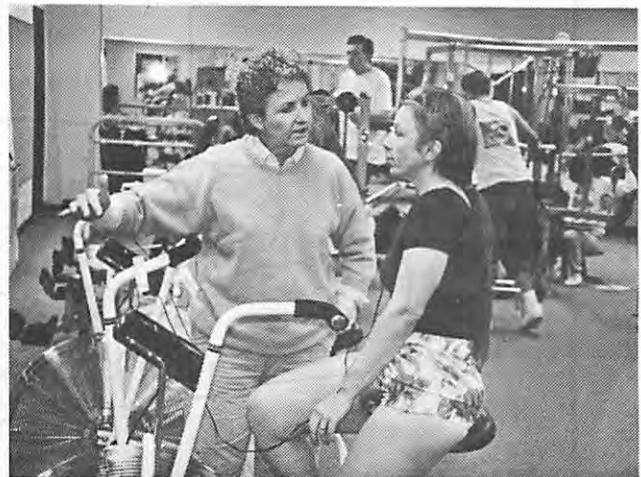

WELLNESS CENTER. Louan Rathke, left, advises a student on the proper use of an exerciser in the new Wellness Center operated by the college in cooperation with the Twin Cities Hospital.

REQUEST FOR INFORMATION

(Date)

Director of Admissions
Okaloosa-Walton Community College
Niceville, Florida 32578

Please forward application forms to me for admission to Okaloosa-Walton Community College. The following information will indicate my interests and my stage of educational development.

1. I have (check the highest level which applies):

- completed junior high/middle school
- received a state high school equivalency diploma
- graduated from high school
- completed some college studies
- received a bachelor's degree
- completed some graduate studies
- received a graduate degree

I would like to enroll as a:

- Full-time student
- Part-time student

3. My interest is the following kind of studies: _____

Name _____

Address _____
(Street or P.O. Box) (City State Zip)

Signature _____

(Please tear out and fold this page for mailing)

**PLACE
POSTAGE
HERE**

**OKALOOSA-WALTON COMMUNITY COLLEGE
100 College Boulevard
Niceville, Florida 32578**

ATTENTION: Admissions Office

**Fold
Here**

(STAPLE OR TAPE HERE)

PHONE NOW!

If you have any questions about entering college, offerings, careers, financing your education, scholarship, any questions at all call one of the following numbers:

Niceville Campus:	678-5111
From Crestview:	682-5272
From Walton County:	892-5145
DeFuniak Springs Center:	892-2174
Eglin AFB Center:	678-3727
Hurlburt Field Center:	581-3006 884-6296
Ft. Walton Beach Center:	244-1000



Editor and Photographer — Lester S. Smith
Compiler and Proofreader — Carlyne Laux
Assistant Proofreader — Becky Tislow
Graphic Services Supervisor — Gwen Street
Graphics Layout and Cover Design — Bob Lester
Typesetter and Graphics Layout — Terry Comeau
Graphic Services Assistant — Don Truitt
Writers — James Durham, David Goetsch, Ken Burdzinski,
Ann James, Chris Bishop

