



# 1994-1995 CATALOG

## OKALOOSA-WALTON COMMUNITY COLLEGE



**SUCCESS BY DEGREES**



"Okaloosa-Walton Community College is dedicated to the concepts of equity and equal opportunity. It is the specific intention of the college not to discriminate on the basis of age, color, creed, handicap, marital status, national origin, race, religion, or sex in its employment practices or in the admission and treatment of students." The Okaloosa-Walton Community College Equity Coordinator may be contacted through the office of the Director of Personnel, Niceville Campus, (729-5365). The Equity Coordinator is also coordinator of Title IX of the Education Amendment of 1972.

---

# OKALOOSA - WALTON COMMUNITY COLLEGE

---

## ACCREDITED BY

SOUTHERN ASSOCIATION OF COLLEGES  
AND SCHOOLS

FLORIDA STATE DEPARTMENT OF EDUCATION

## MEMBER

AMERICAN ASSOCIATION OF COMMUNITY  
JUNIOR COLLEGES

SOUTHERN ASSOCIATION OF JUNIOR COLLEGES

FLORIDA COMMUNITY COLLEGE ACTIVITIES  
ASSOCIATION

FLORIDA ASSOCIATION OF COMMUNITY COLLEGES

---

## DISTRICT BOARD OF TRUSTEES

Eileen H. Arpke

Eltse B. Carter

Walter B. (Mike) Hill

Robert L. Ignasiak

James E. King

C. Jeffrey McInnis

Sally R. Merrifield

Elena M. Roser

James R. (Bob) Richburg  
President and Corporate Secretary

# TABLE OF CONTENTS

<b>CALENDAR OF INSTRUCTIONAL ACTIVITIES</b> .....	v-vii	Motion Pictures .....	24
<b>GENERAL INFORMATION</b> .....	1	Notices .....	24
Accreditation .....	3	Orientation .....	15
Composition of Student Body .....	3	Policy Formulation .....	24
Equal Rights .....	3	Posting, Circulating, and Exhibiting Printed Matter and Filmed Material .....	24
Facilities .....	2	Resolution of Grievances .....	21
Goals .....	1	Services to Students with Special Needs .....	15
History .....	1	Standardized Testing .....	16
OWCC Alumni Association .....	3	Statement of Student Rights and Responsibilities .....	18
OWCC Foundation .....	3	Student Athletics .....	16
Protection of Privacy .....	4	Student Behavior .....	18
Purpose Statement .....	1	Student Discipline .....	19
Year-Round Opportunity .....	3	Student Grievance Procedures .....	21
<b>ADMISSIONS</b> .....	5	Student Handbook .....	18
Adult Basic Education (ABE) .....	7	Student Literacy Corps .....	16
College Credit Admission Requirements .....	5	Student Organizations .....	17, 22
Conditional Enrollment .....	10	Student Publications .....	24
Controlled Admissions .....	10	Student Right-to-Know Graduation Rates .....	19
Enrollment of Foreign Students .....	9	Summary .....	22
Enrollment of Non-Degree-Seeking Students .....	7	Summary of Reported Campus Crimes .....	19
Florida Criminal Justice Training Center Number 21, OWCC .....	10	Time Limits .....	22
General Information .....	5	<b>FINANCIAL AID</b> .....	26
Noncollege Credit Admission Requirements .....	7	Additional Information and Requirements .....	28
Provisional Enrollment .....	7	College Costs .....	26
Special Enrollments .....	7	Deadlines for Applying for Financial Aid at OWCC .....	27
Special Enrollments for High School Students .....	8	Enrollment Status .....	27
<b>FINANCE</b> .....	11	Financial Aid Administered by OWCC .....	30, 31
Cost Summary .....	13	Procedures for Applying for Financial Aid .....	26
Dishonored Check Policy .....	12	Purpose of OWCC's Financial Aid Program .....	26
Fee Changes .....	12	Student Eligibility .....	27
Fines, Penalties, and Indebtedness .....	12	Student Financial Aid .....	26
Fee Schedule .....	13	Veterans' Benefits .....	29
Financial Assistance .....	11	<b>INSTRUCTIONAL PROGRAMS</b> .....	32
General Information .....	11	Academic Advising .....	41
Military Assistance .....	11	Academic Standing .....	33
Parking Fines .....	12	Audit Status .....	32
Refund Policy .....	11	Change of Schedule .....	32
Residency Classification .....	11	Class Attendance .....	32
Student Loans .....	12	College Level Academic Skills Test .....	36
Veteran's Benefits and Assistance .....	11	Communications Department Writing Sample .....	35
<b>STUDENT SERVICES</b> .....	14	Credit by Alternative Means .....	38
Academic Assistance .....	14	Credits For Armed Services Schools and Military Training .....	40
Attendance/Classroom .....	18	Directed Independent Study .....	35
Career Planning Assistance .....	14	Examinations and Grades .....	32
Classroom Activity .....	18	Full-Time and Part-Time Status .....	32
Formal Grievance Procedure .....	21	Incomplete Grades .....	33
Governance .....	14	Nonpunitive Grades .....	33
Guest Speakers .....	23	Requirements for Graduation .....	37
Harrassment .....	23	Satisfactory/Unsatisfactory Grades .....	33
Hazing .....	23	Servicemember's Opportunity College .....	40
Health Services .....	15	Special Comments Concerning English and Reading .....	42
Informal Grievance Procedures .....	21	Special Comments Concerning Mathematics .....	43
Job Placement Services .....	15		

Special Comments Concerning Nursing .....	43
Standards and Regulations .....	32
Transferring to a Senior Institution .....	40
Veterans' Educational Benefits .....	41
Veterans' Fee Deferment Policy .....	41
Withdrawals .....	33
<b>PROGRAMS .....</b>	<b>44</b>
Associate of Arts Degree Program	
Requirements .....	44
Custom-Designed Associate of Arts	
Degree Program .....	47
General Education Requirements	
– Associate of Arts Degree .....	46
Athletics & Physical Education .....	48
Business .....	48
Communications .....	50
Human Development & Continuing	
Education .....	51
Humanities, Fine & Performing Arts .....	52
Mathematics .....	53
Sciences – Biological and Physical .....	53
Public Safety .....	56
Social Science .....	56
Student Bill of Rights .....	45
Associate of Science Degree Program	
Requirements .....	57
General Education Requirements	
– Associate of Science Degree .....	58
Business .....	59
Human Development .....	62
Manufacturing & Technology .....	62
Public Safety .....	66
Associate of Science Degree – Applied Science	
Options Program Requirements .....	67
General Education Requirements .....	67
Occupational Electives – Associate of Science	
Degree .....	68
Business .....	69
Human Development .....	72
Manufacturing & Technology .....	72
Public Safety .....	76
Occupational Certificates .....	77
Business .....	77
Human Development .....	79
Manufacturing & Technology .....	80
Public Safety .....	81
<b>CONTINUING EDUCATION .....</b>	<b>82</b>
Recreation & Leisure	
(Personal Development) .....	82
Noncredit Courses .....	82
Supplemental Education (Professional/	
Technical Development) .....	82
<b>ADULT EDUCATION .....</b>	<b>83</b>
Adult Basic Education .....	83
College Preparatory .....	83
General Education Development (GED) .....	83
Vocational Preparatory .....	83

<b>FLORIDA'S STATEWIDE COURSE</b>	
<b>NUMBERING SYSTEM .....</b>	<b>84</b>
Authority For Acceptance of Equivalent	
Courses .....	86
Equivalency of Sequences .....	85
Exceptions to the Rule For Equivalencies .....	86
Explanation of Prefixes and Numbers .....	85
First Digit .....	85
General Rule for Course Equivalencies .....	85
Lab Indicators .....	85
Titles .....	85
<b>COURSE DESCRIPTIONS .....</b>	<b>87</b>
Adult Education	
Noncredit Courses .....	88
Athletics & Physical Education	
Credit Courses .....	88
Business	
Credit Courses .....	91
Noncredit Courses .....	96
Communications	
Credit Courses .....	98
Noncredit Courses .....	102
Human Development & Continuing Education	
Credit Courses .....	103
Noncredit Courses .....	105
Humanities, Fine & Performing Arts	
Credit Courses .....	106
Noncredit Courses .....	112
Manufacturing & Technology	
Credit Courses .....	112
Noncredit Courses .....	120
Mathematics	
Credit Courses .....	121
Public Safety	
Credit Courses .....	122
Noncredit Courses .....	130
Sciences	
Biological	
Credit Courses .....	132
Noncredit Courses .....	133
Physical	
Credit Courses .....	133
Social Science	
Credit Courses .....	134
Continuing Education Units .....	87
<b>PERSONNEL LISTING .....</b>	<b>137</b>
<b>LOCATION OF COURSE PREFIX BY</b>	
<b>DEPARTMENT .....</b>	<b>144</b>
<b>MAPS:</b>	
Niceville Campus .....	145
Fort Walton Beach Campus .....	146
Eglin Air Force Base Center .....	147
Hurlburt Field Center .....	147
Chautauqua Center .....	148
Robert L.F. Sikes Education Center .....	148
<b>REQUEST FOR INFORMATION .....</b>	<b>149</b>



# Okaloosa-Walton Community College

100 College Boulevard • Niceville, Florida 32578-1294

## OWCC TELEPHONE NUMBERS

CENTERS	NUMBERS
Niceville .....	678-5111
(from Walton County) .....	892-8190
(from North Okaloosa County) .....	689-7870
OWCC/UWF Fort Walton Beach Campus	
(Day) .....	863-6500
(Night) .....	863-6520
OWCC Chautauqua Center .....	892-2174
DeFuniak Springs .....	or 729-5344
OWCC Robert L.F. Sikes Education Center .....	689-7911
Crestview .....	or 729-5343
OWCC Eglin AFB Center .....	678-3727
.....	or 729-5343
OWCC Hurlburt Field Center .....	884-6296
.....	or 729-5345

### Telephone Device for the Deaf (TDD) #'s:

Florida Telecommunication Relay Service	
Voice .....	1-800-955-8770
TDD .....	1-800-955-8771
Student Services .....	729-5236
Evenings .....	729-5276
Business Office, Personnel Office, Equity Coordinator, ADA Coordinator .....	729-5355
OWCC Crestview Center .....	689-7911
OWCC Eglin AFB Center .....	729-5343
OWCC Chautauqua Center .....	892-8100
OWCC Hurlburt Center .....	884-6296
OWCC/UWF Fort Walton Beach Campus .....	863-6504
<b>Student Employment Job Line .....</b>	<b>729-5264</b>

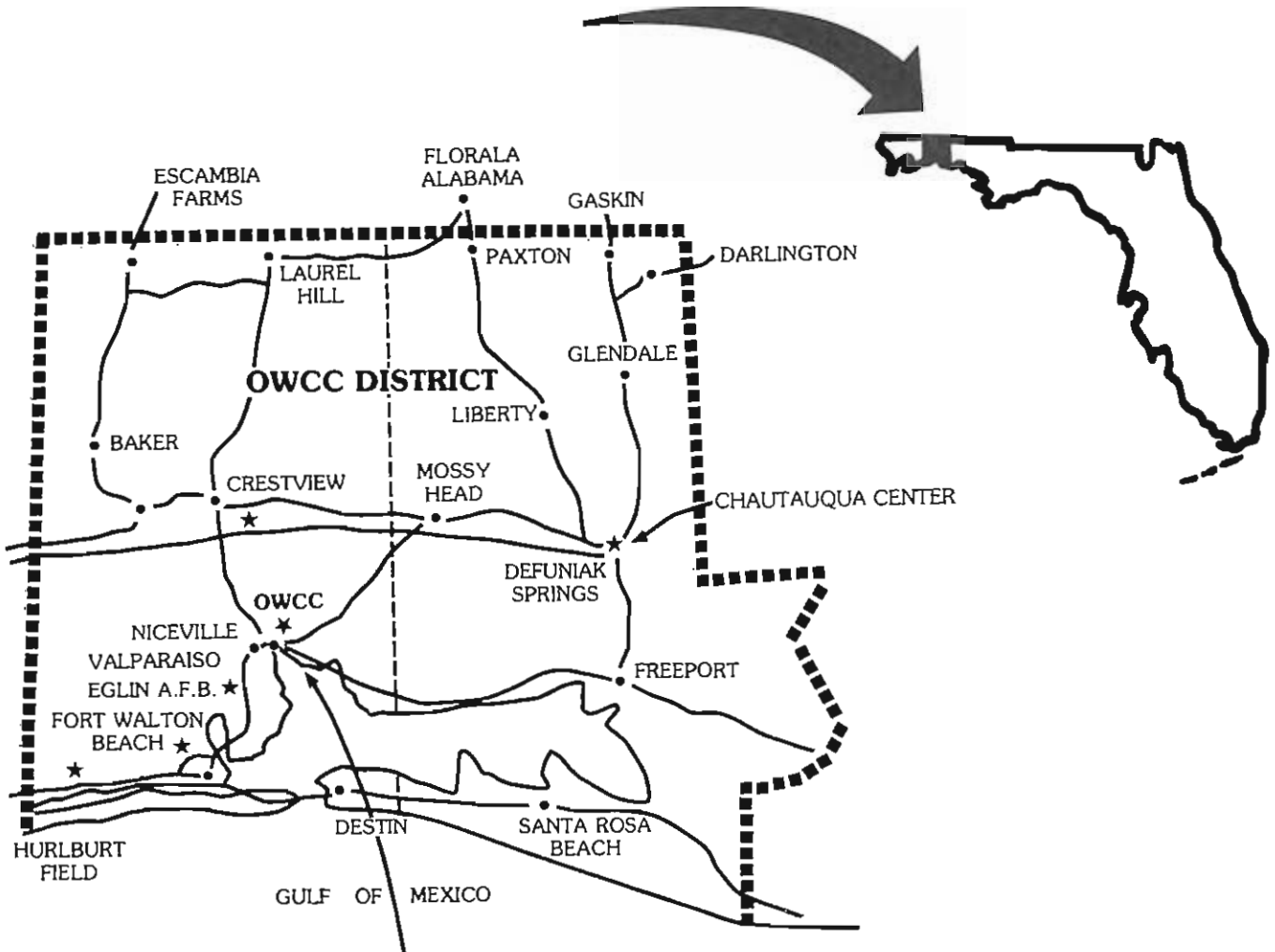

# CALENDAR OF INSTRUCTIONAL ACTIVITIES

## ACADEMIC YEAR 1994-95

### FALL SEMESTER, 1994

Military Registration	Eglin	July 28
	Hurlburt	July 28
Early Registration opportunities for previously and currently enrolled OWCC students (all locations)		July 29, August 1, 2, and 3
New Student Program Planning and Early Registration (by invitation)		August 2-3
Begin Walk-in Registration at All College Locations		August 4
In-Service Workshops (Faculty returns 8:30 a.m., August 15)		August 15-19
Registration for Returning Students		August 17-18
Program Planning and Registration for New Students (times by announcement)		August 18
Cancellation of Classes with insufficient enrollments at the end of the day		August 18
Late Registration and last days to add courses		August 22-26 & 29
<b>Class days:</b>		
College-Credit and Noncredit Classes (Final exams for college credit classes will be December 12-14, Saturday classes on December 10)		August 22-December 9
Last day to pay fees or receive a refund for full term courses		August 29
CLAST Registration Deadline (See "Instructional Programs, Standards and Regulations" for details)		September 2
Graduation Application Deadline		September 2
<b>COLLEGE CLOSED</b>		<b>September 5</b>
College Level Academic Skills Test (CLAST)		October 1
Mid-Term Grades due in Registrar's Office by 3:30 p.m.		October 18
Deadline for withdrawing from college preparatory courses to avoid the three-term enrollment limit		October 18
Last day to drop a course with a grade of "W" or to change to "Audit" status: Term-length course by 4:30 p.m. (Deadline for courses meeting less than full term: Mid-point plus 3 working days)		October 25
<b>Student Teacher Holiday</b>		<b>November 11</b>
<b>COLLEGE CLOSED</b> (Note: Saturday classes will not meet on November 26)		<b>November 23-25</b>
Military Registration	Eglin	December 1-2
	Hurlburt	December 1-2
Early Registration opportunities for Spring Semester for previously and currently enrolled OWCC students (by announcement)		December 3, 5, 6, and 7
Early Registration opportunities for Spring Semester for new students (by invitation)		December 6-7
Walk-in Registration		December 8, 9, and 12-14
Final Examinations for college-credit courses (Note: Final Examinations for Saturday classes will be given on Saturday, December 10)		December 12-14
Final Grades due in Registrar's Office (2:00 p.m.)		December 15
<b>COLLEGE CLOSED</b>		<b>December 19-31</b>

### SPRING SEMESTER, 1995

Faculty Returns (8:30 a.m.)		January 2
Registration for Returning Students		January 3
Program Planning and Registration for New Students		January 3
Cancellation of classes with insufficient enrollment at the end of the day		January 3
Late Registration and last day to add courses		January 5, 6 and 9-12

**Class days:**

College-Credit and Noncredit Classes (Final Exam dates April 28, May 1 & 2)	January 5 - April 27
Last day to pay fees or to receive any refund of fees for full term courses	January 12
<b>COLLEGE CLOSED</b>	<b>January 16</b>
Graduation application deadline for Spring Semester (all programs) at 4:30 p.m.	January 20
CLAST Registration Deadline (See "Instructional Programs, Standards and Regulations" for details)	January 20
College Level Academic Skills Test (CLAST)	February 18
Mid-Term Grades due in Registrar's Office by 12:00 p.m.	February 28
Last day to drop a course with a grade of "W" or to change to "Audit" status:	
Term-length course	March 6
(Deadline for courses meeting less than full term: Mid-point plus 3 working days)	
<b>Student Teacher Holiday</b>	<b>March 20</b>
<b>COLLEGE CLOSED</b>	<b>March 21-24</b>
Military Registration Eglin	April 20-21
Hurlburt	April 20-21
Early Registration opportunities for Summer Semester for previously and currently enrolled OWCC students by announcement)	April 22, 24, and 25
Early Registration opportunities for Summer Semester for New Students	April 24 and 25
Walk-in Registration at all locations	April 26-28
Final Examinations (college-credit courses)	April 28, May 1 and 2
(Saturday classes finals will be given on Saturday, April 29)	
Final Grades due in Registrar's Office (2:00 p.m.)	May 3
Faculty In-Service Days	May 4-5
Graduation	May 5

---

**SUMMER SEMESTER, 1995, TWELVE-WEEK SEMESTER**

---

General Registration for all students	May 3
Cancellation of classes with insufficient enrollment at the end of the day	May 3
CLAST Registration Deadline (See "Instructional Programs, Standards and Regulations" for details)	May 5
Late Registration and last day to add courses	May 8 -12, and 15
<b>Class days:</b>	
College-Credit and Noncredit Classes	May 8-August 1
Last day to pay fees or to receive any refund of fees for full-time courses	May 15
<b>COLLEGE CLOSED</b>	<b>May 29</b>
College Level Academic Skills Test (CLAST)	June 3
Last day to drop a course with a grade of "W" or change to "Audit" status:	
Term-length courses	June 26
(Deadline courses meeting less than full term: Mid-point plus 3 working days)	
<b>COLLEGE CLOSED</b>	<b>July 4</b>
Graduation application deadline	July 5
Military Registration Eglin	July 27
Hurlburt	July 27
Early Registration for returning students	July 28, 31, and August 1
Early Registration for new students (by invitation)	August 1
Final grades due in Registrar's Office (4:00 p.m.)	August 2

---

**SUMMER SEMESTER, 1995, TERM I, FIRST SIX WEEKS**

---

General Registration for all Students	May 3
Cancellation of classes with insufficient enrollment at the end of the day	May 3
Late Registration and last day to add courses	May 8 - 11
<b>Class days:</b>	
College-Credit and Noncredit Classes	May 8-June 19
Last day to pay fees or to receive any refund of fees for full-term courses	May 11
<b>COLLEGE CLOSED</b>	<b>May 29</b>



Last day to drop a course with a grade of "W" or to change to "Audit" status:	
Term-length courses .....	May 31
(Deadline for courses meeting less than full term: Mid-point plus 3 working days)	
College Level Academic Skills Test (CLAST) .....	June 3
Final Grades due in Registrar's Office (4:00 p.m.) .....	June 19

**SUMMER SEMESTER, 1995, TERM II, SECOND SIX WEEKS**

Registration for Returning Students (times by announcement) .....	June 15-16
Program Planning and Registration for New Students (times by announcement) .....	June 16
Cancellation of classes with insufficient enrollment at the end of the day .....	June 16
<b>Class days:</b>	
College-Credit and Noncredit Classes .....	June 20-August 1
Late Registration and last day to add courses .....	June 20-23
Last day to pay fees or receive any refund of fees for full-term courses .....	June 23
<b>COLLEGE CLOSED</b> .....	<b>July 4</b>
Graduation application deadline .....	July 5
Last day to drop a course with a grade of "W" or to change to "Audit" status:	
Term-length courses .....	July 14
(Deadline for courses meeting less than full-term: Mid-point plus 3 working days)	
Final Grades due in Registrar's Office (4:00 p.m.) .....	August 2



*Students enjoy a sunny day at the Okaloosa-Walton Community College/ University of West Florida Fort Walton Beach Campus.*



*The OWCC Robert L. F. Sikes Education Center in Crestview, located on Highway 90 East, is the newest full-time OWCC instructional site.*

# GENERAL INFORMATION

## PURPOSE STATEMENT

Okaloosa-Walton Community College is committed to quality educational programs and services providing the opportunity for students to achieve their goals and for satisfying community needs. To this end, the college seeks to help improve the quality of life by offering excellence in academic, occupational, cultural, economic, and personal development programs.

## GOALS

To provide a college environment that promotes equity and access to college programs for all citizens.

To provide student and community services and activities that enhance the quality of educational life.

To provide freshman and sophomore courses leading to baccalaureate degrees.

To provide two-year degrees that prepare students for careers in the public and private sectors.

To provide support to the economic development of Okaloosa and Walton counties.

To provide adult literacy programs, including adult basic education, General Education Development (GED) preparation, and vocational preparatory instruction.

To provide social and cultural enrichment opportunities in Okaloosa and Walton counties.

To provide a variety of opportunities for continuing education.

To provide preparatory instruction in basic skills.

## HISTORY

Thirty years of service and outstanding accomplishments is, in brief, the history of OKALOOSA-WALTON COMMUNITY COLLEGE! From the earliest days of its activation, OWCC has been in operation as the college for Okaloosa and Walton counties.

OWCC serves approximately 16,000 persons annually. In this thirty years it has served more than 100,000 persons; a consistent record of education for excellence through the success of students transferring to senior institutions; received many acknowledgements and recognition, including a citation by the U.S. President in 1972.

In 1984, the College received the coveted "Secretary's Award" from the U.S. Secretary of Education for its Drafting and Design Technology program for Region IV.

Initial founding and funding took place on April 16, 1963, by action of the State Legislature. In prompt succession the initial Advisory Committee, now the District Board of Trustees, was appointed (December 1963); the first President employed (February 15, 1964); the College named (March 3, 1964); its temporary location established (April 3, 1964); its faculty employed (August 17, 1964); and its first classes begun on a beautiful morning (August 24, 1964) on the quaint, temporary campus in Valparaiso, Florida.

The temporary size of approximately twelve acres was centered around Perrine Park in Valparaiso. The Twin Cities of Niceville and Valparaiso, Florida, contributed to the initial conversion of the park and buildings into a collegiate campus. The campus consisted of seven buildings at the time of its opening session, August, 1964. The facilities had increased to twenty-three buildings to accommodate the broader range of programs and the greatly expanded student enrollment by the fall of 1968.

The permanent site of the Niceville campus is located between State Road 85 and State Road 285 in a beautiful wooded area. It was designated on November 24, 1965. Transfer of 264 acres of land from the Eglin Air Force Reservation was made by an Act of Congress in January, 1966, to Okaloosa-Walton Community College.

Ceremonies dedicating the permanent site were held April 10, 1969. These ceremonies included establishing the Robert L.F. Sikes Honorary Faculty Chair in Government, the Emil Holzhauser Honorary Faculty Chair in Arts, and the acceptance of the Emil Holzhauser collection of paintings for perpetual care by the OWCC Library.

The philosophy which undergirded the planning of the permanent facility, as summarized by OWCC Charter President, Dr. J.E. McCracken, states "We envision . . . through our program, a movement that will enable an individual to experience all aspects of our great heritage - from arts to sciences; from chemical creativity to technical productivity; from contemplation of primeval origins to consideration of ultimate destinies."

## FACILITIES

The Niceville campus of Okaloosa-Walton Community College has been cited as an outstanding example of a much-needed return to human dimensions in college environments. It was occupied in January of 1969. The warm, inviting profiles of the buildings and their natural setting confirm a central commitment of the college – "No one a stranger; a stranger to no one".

The Niceville campus includes the following permanent facilities:

**Administration (A):** houses the executive and administrative offices, including instructional services, administrative and financial services, media/public relations and the college foundation .

**Technical Laboratories (B):** contains electronics, drafting and design, and computer-assisted drafting laboratories.

**Student Services Center (C-1):** houses admissions, registration, counseling, financial aid advisement services, and Career Information Center.

**Business (C-2):** provides facilities for instructional programs in business education, business administration, secretarial science, word processing, and mid-management.

**Science (D):** comprised of classrooms and laboratory facilities for programs in biology, physics physical science, and chemistry.

**Learning Resources Center (E):** located on the two center floors and the south mezzanine of Building "E". It contains a collection of more than 81,000 books, 36,000 audio-visual items, and subscribes to about 600 magazines and newspapers.

The upper mezzanine levels house the Academic Success Center, faculty offices and classrooms on the north side. The Periodicals/Reserve and Audio/Visual sections of the LRC are on the south side .

The ground floor level contains faculty offices, classrooms, Graphic Services and Instructional Graphics/Printing. A conference center is located on the ground level.

**Athletics and Physical Education (F):** contains offices, classrooms, and storage facilities for the Division of Athletics and Physical Education department, and houses the Wellness Center.

**Outdoor Physical Education Facility (F-1):** contains extensive outdoor facilities which provide activity programs for intramural and intercollegiate participation.

**Utilities, Maintenance, and Receiving (G) and (G-1):** houses the air conditioning and heating equipment, central services, maintenance, custodial and grounds functions.

**Gymnasium (H):** a multi-purpose facility used to house all indoor physical education activities and

indoor sports events, as well as serving as a center for convocations, theatrical productions, and community cultural events.

**College Mall (K):** contains student activities, food services, bookstore, lounges, meeting rooms, recreational areas, instructional programs in music and humanities.

**Mathematics/Public Safety (L):** provides offices, classrooms, and specialized laboratories for the mathematics department and facilities, including a crime scene room and forensics photo lab, for programs offered by the Florida Criminal Justice Training Center No. 21.

**Visual Arts (M):** houses instructional art programs.

**Continuing Education (P):** contains classrooms and laboratories for consumer and home economics education, continuing education, adult education, and a Child Development & Education Center.

**Industrial Laboratories (Q):** houses shops and classrooms.

**Computer Services (R):** provides laboratories and related instructional facilities for the computer science program. The College's Management Information Systems staff is located in this facility.

**The Sports Complex:** The sports complex is located east of the Niceville campus and contains a golf course, and two diamonds, bleachers, field houses for men's and women's baseball and softball and a Strength Training Center.

OWCC operates instructional sites throughout the two county area, making the programs and services of the college easily accessible to the entire community.

**The OWCC Chautauqua Center (N):** located in DeFuniak Springs, Fla., this multi-purpose community service facility was constructed through a Housing and Urban Development grant matched by donated funds from Walton County. Diversified noncredit programs and credit courses are offered in this facility, as are services to those with special needs. The Center houses a Title XX Child Care Center.

**The Okaloosa-Walton Community College and the University of West Florida Fort Walton Beach Campus** provide postsecondary education, adult general education, undergraduate programs, and graduate school programming through a 2+2 arrangement between the two institutions. The OWCC/UWF Campus is located on Martin Luther King, Jr. Boulevard in Fort Walton Beach. The newly constructed facility became operational in August 1992 on the 152-acre site acquired in a unique exchange of properties by the U.S. Air Force, U.S. Department of Forestry and the State of Florida.

The Robert L.F. Sikes Education Center in Crestview is located on Highway 90 east. OWCC acquired the Bob Sikes Public Library building and land in October, 1993. The college operates a full-time center at the site which offers college credit, adult basic education and other courses. Six new classrooms and additional administrative/student services will be open for fall semester 1994. The city of Crestview operates the public library located at the facility.

**OWCC Eglin Air Force Base and OWCC Hurlburt Field Center:** Postsecondary programs are offered at these locations, with special programs and services designed for active duty military personnel, civil service personnel, contract personnel, and for the general citizenry on a space available basis.

## **OWCC FOUNDATION**

The Okaloosa-Walton Community College Foundation was created to provide scholarships and support for programs and activities which enhance the quality of education for OWCC students and expand educational opportunities.

Authorized by the College's District Board of Trustees in January 1988, the OWCC Foundation has a 23-member board. Five board members make up the Foundation's Executive Committee and administer the organization's activities along with the Foundation's executive director.

A chartered, nonprofit organization under Internal Revenue Service (IRS) regulations, the OWCC Foundation is empowered to seek and receive gifts from individuals, organizations, corporations, and other sources.

The OWCC Foundation has identified certain areas for support. These include: the Scholarship Fund; the Library/Learning Resources Fund; the Personnel and Curriculum Development Fund; the Fine and Performing Arts Fund; and the Endowment Fund.

The OWCC Foundation operates under a philosophy of building principal and using the interest to support the various funds. Endowment building is assisted by a state matching program called the Florida Academic Improvement Trust fund. This fund enables many gifts to be matched on a 60/40 basis. No portion of donations is used for administrative purposes. A Foundation President's Club has been created through which a \$50 annual pledge helps underwrite operational expenses.

For further information contact the OWCC Foundation Office at (904) 729-5210.

## **OWCC ALUMNI ASSOCIATION**

The Okaloosa-Walton Community College Alumni Association provides all former students and graduates with an organization to promote the interests of OWCC. Alumni help support causes

which enhance educational opportunities and perpetuate friendships made while attending OWCC.

Membership in the OWCC Alumni Association is open to all graduates of the college and to any student who has attended OWCC.

The Alumni Association, in cooperation with the college, participates in various activities and sponsors events. It encourages creation of OWCC Alumni chapters at senior institutions. The association attempts to provide resources to help in scholarships and other program support beneficial to OWCC.

For additional information about the OWCC Alumni Association contact the OWCC Foundation and Alumni office at (904) 729-5210.

## **YEAR-ROUND OPPORTUNITY**

The college's programs of continuing study vary considerably in their timing. Enrichment programs, workshops, institutes, and numerous community services and certificate programs are offered on demand as sufficient requests occur. Special programs are announced as they are developed. The public is especially invited to request short or extended offerings in areas of need or interest. These can be provided as long as 12 or more adults are involved.

## **COMPOSITION OF STUDENT BODY**

Okaloosa-Walton Community College is a coeducational institution serving approximately 16,000 students annually of all ages who are legally out of high school.

## **ACCREDITATION**

Okaloosa-Walton Community College is accredited to award associate degrees and certificates by the Commission on Colleges of the Southern Association of Colleges and Schools.

## **EQUAL RIGHTS**

Okaloosa-Walton Community College is dedicated to the concepts of equity and equal opportunity. It is the specific intention of the college not to discriminate on the basis of age, color, creed, handicap, marital status, national origin, race, religion, or sex in its employment practices or in the admission and treatment of students. The OWCC Equity Coordinator may be contacted through the Office of the Director of Personnel, Niceville campus, extension 365. The Coordinator is designated to coordinate compliance with the Florida Educational Equity Act and information about the availability of the OWCC Grievance Procedure. The Equity Coordinator is also Coordinator of Title IX of the Education Amendments of 1972.

## PROTECTION OF PRIVACY

The following information may be released at the discretion of the college.

**Directory Information:** Name, address, telephone number (if it is a listed number), date and place of birth, major field of study, participation in officially recognized activities and sports, weight and height of members of athletic teams, dates of attendance, degrees and awards received, and the most previous educational agency or institution attended.

Under the Family Rights and Privacy Act of 1974, students have the right to withhold the information listed above. A student may withhold information listed above by obtaining a notification to deny disclosure of directory information form from the Director of Student Services. This form must be completed and turned in to the Director by the end of late registration for each semester or term. A form for non-disclosure must be submitted each academic semester or term to remain in effect.

The custodian of student records may release information from these records to others only upon authorization in writing from the student or upon order of a court of competent jurisdiction except as required by the president in the discharge of his duties as authorized by law, the state, and the board.



*Approximately 16,000 students are enrolled annually at OWCC. The average student age is 27 years old. Females comprise 55% of the student population, males 45%.*



*OWCC operates full-time instructional centers at Hurlburt Field and Eglin Air Force Base, making the programs and services of the college easily accessible to the military community and other students who reside near the base.*

# ADMISSIONS

## GENERAL INFORMATION

All OWCC district residents legally out of grades K-12 are eligible to be admitted to OWCC. However, the college reserves the right to deny admission to any program for applicants categorized in the section on Controlled Admissions (see page 10).

Applicants for courses or programs offered by Okaloosa-Walton Community College may obtain appropriate admission forms from the Admissions office. These forms are available at the Niceville campus, at Building 251 on Eglin AFB, at the OWCC Chautauqua Center in DeFuniak Springs, at the OWCC office on Hurlburt Field, at the OWCC/UWF Fort Walton Beach Campus, at the OWCC Robert L.F. Sikes Education Center in Crestview, and at all high schools in the OWCC District. Each applicant will be notified of acceptance or non-acceptance for admission.

All forms and supporting documents must be submitted in sufficient time to permit processing and notification of admission status prior to registration. In unusual cases where this is not feasible, applicants may be conditionally enrolled as provided on page 10. (This does not apply to dual enrollment and foreign student applicants). Applicants whose circumstances are unique may request special consideration for admission through a formal petition. Registration for applicants admitted in this category normally will be authorized on a space available basis.

Any decision on admissibility by the Registrar may be appealed to the Admissions Committee. A decision of the Admissions Committee may be appealed to the President via the Vice-President for Instruction.

**FALSIFICATION OR FAILURE TO FURNISH CORRECT INFORMATION ON ADMISSION PAPERS WILL SUBJECT APPLICANTS TO DENIAL OF ADMISSION OR IMMEDIATE DISMISSAL.**

## COLLEGE CREDIT ADMISSION REQUIREMENTS

College-credit programs at Okaloosa-Walton Community College include the Associate of Arts Degree Programs, Associate of Science Degree Programs, the Associate of Science, Applied Science Options Degree Programs, Occupational Certificate Programs, College Preparatory Programs, and individual credit course enrollments.

Each applicant for college-credit programs or courses at OWCC must submit with the completed

application a \$15 nonrefundable admission processing fee. In addition, a properly executed Residency Declaration must be submitted by applicants who claim Florida residency (see page 11, Residency Classification).

All students seeking admission to the Associate of Arts Degree Program who graduated from high school after August 1, 1987, with other than a standard Florida public high school diploma, must provide an official high school transcript verifying their completion of a secondary school curriculum. This must include four years of English and three years of mathematics, science, and social studies, or they must provide evidence of receipt of a General Education Development diploma. Applicants not meeting these requirements will be classified **Pre-AA Degree** until such time as these conditions are met. (See Admissions or OWCC Center personnel for additional information).

**Entry-level Testing.** Florida Statutes specify that selected standardized tests must be used to measure achievement of college-level communication and computation skills for admissions counseling and placement of students entering degree programs. OWCC accepts minimum scores earned on all tests approved by the State Department of Education, which includes ACT, ASSET, MAPS, and SAT.

OWCC administers the new ASSET as the primary placement test. See current schedule of classes for minimum scores on other placement tests. Students scoring below the cutoff level in one or more categories of a state required placement test are required to enroll in at least one college prep course each semester until all deficiencies are removed with a minimum grade of "C." Only three attempts are allowed in each college prep course according to State Department of Education rules. Withdrawals prior to the mid-point of a college prep course do not count as one of the three attempts (per state board rules).

Writing samples are required for placement in ENC 1101, English Composition I. Samples are graded by the English faculty for determination of proper placement in the English sequence. Students who have placement test scores above the cutoff but have a score of 2 or below on the writing sample are required to enroll in LIN 1670 Writing and Grammar (a degree credit course) before enrolling in ENC 1101 English Composition I.

Students who have placement test scores above the cutoff but have a score of 2 or below on the writing sample are required to enroll in LIN 1670 Writing and Grammar (a degree credit course) or may elect to enroll in College Prep before enrolling in ENC 1101 English Composition I.

In mathematics, students with new ASSET scores below 37 take MAT 0024 College Prep Algebra, or MAT 0002 Developmental Arithmetic, as appropriate prior to enrolling in MAC 1102 Introductory College Algebra. Students whose scores on the new ASSET Arithmetic test are below 44 will be required to enroll in MAT 0002 before enrolling in MAT 0024.

A student's indicated program will determine when entry-level testing has to be completed. Full-time, degree program students (those taking 12 hours or more) must take the ASSET, MAPS, or other approved test prior to completing registration. Part-time degree program students (those taking less than 12 hours) may defer the test up to 12 cumulative hours of college work.

Students not seeking a degree will be classified as "General Freshman" until they declare a major or specialization. However, they must fulfill the entry-level placement testing requirements before enrolling in English, mathematics or humanities courses.

**All students planning to enter associate degree programs should endeavor to: (a) have ACT, SAT, ASSET or MAPS test scores\* on file with OWCC prior to enrolling or (b) take the test administered by OWCC on one of the college's scheduled testing dates prior to completion of registration for classes.**

Placement test scores are required for entering a degree program at the college — for placement in college preparatory or regular degree-credit courses in computation (mathematics), communications or reading.

The testing schedule will be published in the **Schedule of Classes** for each registration period. Additional testing may be scheduled on an "as needed" basis. The ASSET, or other approved test, is ordinarily administered at OWCC only for persons with an application on file.

Placement test score requirements for entry into degree-credit mathematics, communications and humanities courses are based on rules of the State Board of Education. They will be announced each semester in the **Schedule of Classes**.

**Students may not take mathematics, communications or humanities courses which are higher than the level authorized by their entry-level placement test results. Students with entry test scores below those specified in State Board Rules and who intend to pursue degree-credit mathematics, communication and humanities courses may enroll only in college preparatory courses. These include the following: College Preparatory English, Developmental Arithmetic, College Preparatory Algebra, and College Preparatory Reading.**

Students limited to college preparatory courses are permitted to enroll in other curriculum areas for which they are qualified. It is recommended that students complete all college preparatory work prior to enrolling in any course in the Biological or Physical Sciences. Students should work

closely with counselors, educational advisors, and faculty advisors in scheduling classes and planning their total education program to move most effectively toward graduation.

**First-Time-In-College Applicants** (i.e., new students, applicants without prior college work) are responsible for submitting completed, full sets of application forms and related documents. In addition, one of the following types of documentation must be provided, as appropriate:

1. An official record of high school work which documents graduation. These forms must be mailed directly to the OWCC Admissions Office by the high school last attended.

2. Evidence of receipt of a high school equivalency diploma from a state department of education, or

3. Evidence of qualification for provisional enrollment as a non-high school graduate by virtue of age or by award of a certificate of attendance from a public high school (see page 7, "Provisional Enrollment").

**Applicants With Prior College Work** (i.e., transfer students or returning OWCC students) are responsible for submitting completed, full sets of admission/readmission application forms and related documents. In addition, they must provide official transcripts covering all course work attempted at all colleges or universities previously attended. (These transcripts must be mailed directly to the OWCC Admissions Office from the respective institutions. *Hand carried documents will not be accepted*).

Transfer students admitted to the college with a cumulative grade point average which by OWCC standards would be considered less than good standing will be subject to probation rules (see page 34).

Transfer applicants whose academic records, by OWCC standards, would have caused their suspension will not normally be considered for admission until at least one semester has elapsed since enrollment at the last institution attended, and the individual shall be subject to the Okaloosa-Walton Community College policies relative to suspension (see page 34).

Transfer credit may be accepted from degree granting institutions that are accredited by one of the six Regional Associations. Where Regional Associations use accrediting commissions, accreditation must have been granted by the Commission on Colleges or the Commission on Institutions of Higher Learning. Candidacy status in one of six Regional Associations by the appropriate commissions will be accepted as accreditation. *Credit taken at nonaccredited institutions will not be accepted for transfer to Okaloosa-Walton Community College.*

\*Scores for tests taken within the past three years at other test centers will be accepted.



## **ENROLLMENT OF NON-DEGREE-SEEKING STUDENTS**

Nondegree-seeking students are persons who take selected college courses without the intent of completing a certificate or associate degree program. Many students attend the college to upgrade employment skills, for transfer credit, or for personal interest and enjoyment. Nondegree applicants only need to provide a completed Application for Admission and Data Form and a Florida Residency Declaration. Upon changing to degree-seeking status at OWCC or upon earning 24 semester hours, high school/college transcripts, as appropriate, will be required.

Interim-study students (i.e., transient students who normally seek enrollment only for one semester or term and whose enrollment is to be only as part of their pursuit of a degree at another institution) are advised to obtain, preferably in writing, their parent institution's authorization of course selection.

## **NONCOLLEGE CREDIT ADMISSION REQUIREMENTS**

Noncollege credit programs at Okaloosa-Walton Community College include Adult Basic Education (ABE), Vocational Preparatory/General Education Review, citizenship, occupational courses, and self-supporting recreational and leisure-time courses. Applicants for admission to noncredit programs must submit the appropriate application materials and meet the specific admission requirements for the programs they want to enter.

## **ADULT BASIC EDUCATION (ABE)**

This program leads to the completion of elementary and secondary studies, including basic reading, writing and mathematics. Adult Basic Education classes are designed for adults who need to develop skills in reading, writing and arithmetic. It includes other subjects related to gainful employment, such as obtaining the Florida High School Diploma (through the GED test), or learning to speak English. Eligibility requirements are as follows:

1. Applicants must be 16 years old.
2. Applicants normally must not have received a regular high school diploma or passed the General Education Development Test (GED). (Applicants who have a high school diploma or passed the GED, yet cannot pass a state approved test at the 9th grade level, may enroll in the ABE program).

3. Unsuccessful on a college prep subject on three attempts. (A fee is usually assessed.)
4. Okaloosa County residents under the age of 18 must present a letter of permission from the school board office of Pupil Personnel Services before enrolling in an ABE program.

## **SPECIAL ENROLLMENTS**

### **PROVISIONAL ENROLLMENT**

Students legally out of high school but who lack a high school diploma may be granted permission to enter the Applied Science option of the Associate of Science degree program or an Occupational Certificate program on a provisional basis.

The student will continue in this category until one of the following conditions is met, at which time, admission to the Associate of Science degree, applied science option or certificate program will be granted upon request:

1. The standard requirements for entry into college credit programs are completed.
2. A minimum of 16 or more semester hours of general education courses are completed, or
3. Thirty-six (36) semester hours of occupational skills courses with an overall grade point average of 2.0 or higher are earned.

Applicants enrolled on a provisional basis are encouraged to prepare themselves for the GED test. Adult Basic Education classes, Vocational Preparatory classes, the Learning and Writing Skills Laboratory, tutoring, and a mathematics laboratory are provided to assist the individual in preparing for the GED test.

Persons seeking to enroll in the Associate of Arts program are NOT eligible for provisional enrollment because a high school diploma is required for admission to AA programs. Persons who expect to receive a high school or GED diploma and who seek to pursue an AA program should, without delay, consult with the Admissions Office about eligibility for "Conditional Enrollment."

## **SPECIAL ENROLLMENTS FOR HIGH SCHOOL STUDENTS**

OWCC has special concurrent enrollment programs to provide a means for educational acceleration for academically superior high school students. These have evolved into the following admission categories (maximum of 7 semester hours in concurrent and/or dual credit):

- A. **Concurrent Enrollment** is available on the Niceville campus or at any center of the college for persons enrolling in noncredit courses and credit courses which do not apply toward their high school diploma provided for under provisions of part-time dual credit. Students enrolled in these courses pay standard college application, registration, laboratory and special tuition fees where applicable. Credits earned under this enrollment category count only for college degree-credit purposes and do not carry simultaneous high school unit credits (See paragraph B for simultaneous credit options). Criteria to be applied for students taking courses on the Niceville campus or at one of the college centers while concurrently enrolled with their own high schools are as follows:
1. Principal's recommendation for participation in courses for which fees must be paid.
  2. Candidates must be high school students (grades 10 through 12 whose grades averaged 3.0 or higher in grades 9 through 11 or have a waiver authorized by their high school principal. Grade point average is not applicable for enrollment in noncredit courses).
  3. Students may enroll at the college for a maximum of seven (7) semester hours of college credit work or fifteen (15) contact hours per week of noncredit courses each semester.
  4. Students must comply with all rules and regulations of the college and must maintain a "C" average or better. Substandard academic performance at the college or failure to comply with college rules and policies will result in the enforced withdrawal of the student from the program. Enrollment at the college should in no way jeopardize completion of regular high school work.
  5. A student's academic work at the college will be validated only upon graduation from high school, whether or not enrollment at the college is continued.
  6. Any student enrolled under these provisions will be required to sign a statement that he or she understands that the college credits earned while simultaneously enrolled in high school are not necessarily transferable to any college in Florida or elsewhere in the United States until after their validation by the College Registrar. (See item 5).

- B. **Part-time Dual Credit Enrollment\*** Admission to college courses for dual high school/college credit is offered during and after normal high school class hours, on-site in high school facilities, and in other regularly scheduled college classes within the two-county district served by OWCC. The agreements between Okaloosa-Walton Community College and the Okaloosa and Walton County School Districts are coordinated through the Office of the Vice President for Instruction at the college and the Offices of the Superintendents of the respective school systems. These persons, or their designees, work cooperatively with college department chairs and school principals in the implementation of this program.

Criteria to be applied for students taking courses for high school/college credit are as follows:

1. Students shall:
  - a. be classified as secondary students as approved in the College-School System Dual Credit Agreements,
  - b. have a cumulative grade point average of 3.5 or higher on all academic coursework beginning with Grade 9 through current high school grading period (or have permission of the high school principal), and
  - c. be recommended by the principal of their own high school.
2. Courses to be offered shall be standard college degree-credit courses, exclusive of activity physical education courses. Determination of offerings and arrangements for scheduling such offerings in public school facilities shall be made cooperatively with the principal and such other officials of the public school system and of the college as are pertinent. Students may also enroll for college classes offered on the Niceville campus and at any of the college centers.
3. The units creditable toward high school graduation and college credits leading toward a degree shall be simultaneously earned by students who have passing grades in the courses approved by the student's high school and shall be limited to a maximum of seven credit hours per semester.
4. Students enrolling in college credit courses under this program will be classified as "Limited Enrollment" college students, and they will be limited specifically to college credit courses offered under the Dual Credit Enrollment Program until such time as they become eligible for unconditional admission to the college.

\*NOTE: No fees are charged to students enrolled in the Dual Credit Enrollment Program, except for activity physical education course fees, which cannot be waived.

5. No fees shall be charged to students enrolled in the Dual Credit Enrollment Program. There will be no charge for textbooks and nonconsumable workbooks, which must be returned by the students at the end of each course prior to release of grades or credits.
6. Students participating in this program will be required to sign a statement that they understand that college credits earned while simultaneously enrolled in high school are not necessarily transferable to any college in Florida or elsewhere in the United States until after validation by the College Registrar.

C. **The Full-Time Dual Credit Enrollment Program\*** for superior students at Okaloosa-Walton Community College will admit a limited number of highly-qualified applicants after completion of their junior year in an accredited high school. To be considered for this program, students must rank in the top 10 percent of their class, score at the 75th percentile or higher on an accepted college entrance examination, have the unqualified consent of their parents, and present the favorable recommendation of their principal. Approval of the Admissions Office based on a personal interview is also required before a final decision can be made. All admission requirements must be met prior to the regular registration period for the semester/term in which the applicant expects to enter. Applicants who are accepted will be placed in appropriate courses for which they are qualified. A student's coursework at OWCC will be validated only upon graduation from high school, whether or not enrollment at the college is continued.

## **ENROLLMENT OF FOREIGN STUDENTS**

The first priority of the college is to provide educational services for students in the OWCC District. Upon fulfillment of this priority, eligible out-of-state and foreign students are welcome to attend OWCC. The following criteria are established for selective admission of foreign students enrolling for college credit courses at OWCC:

At Okaloosa-Walton Community College, admission of foreign students is a selective process. All required documents are to be completed and on file with the Admissions Office four (4) months before the first day of the semester in which the student hopes to enter the college. Okaloosa-Walton Community College will NOT accept transfer credit from foreign colleges or universities UNLESS THEY ARE ACCREDITED BY A REGIONAL UNITED STATES ACCREDITING AGENCY.

\*NOTE: No fees are charged to students enrolled in the Dual Credit Enrollment Program, except for activity physical education course fees, which cannot be waived.

The following required documents **MUST BE TRANSLATED INTO ENGLISH** and **COPIES MUST BE CERTIFIED BY A QUALIFIED INDIVIDUAL**.

1. High school transcripts and/or evidence of academic achievement equivalent to a U.S. high school education with at least a "C" average or graduation in upper one-third of graduation class must be presented at the time of applications for admission.
2. Test of English as a Foreign Language (TOEFL) results are required of applicants for whom English is not the primary language. The minimum required score is 525. This college DOES NOT give the TOEFL test. TOEFL scores must be sent to the college from the testing agent. Scores will not be accepted directly from the applicant.
3. A complete certification of finances form contained in the admissions package is required. Students are required to provide proof of finances that would cover the expense of two years in college (approximately \$29,866 U.S. dollars.) Fees are subject to change but the current estimated yearly costs are:

Tuition and fees .....	\$3,548
Books and supplies .....	744
Housing .....	7,274
Transportation .....	1,099
Personal and medical .....	2,268
Total cost per year .....	\$14,933

Foreign students are classified as non-Florida residents, pay out-of-state fees and may not be reclassified during their enrollment at the college while in an F-1 status. Opportunities for scholarships are very limited.

4. Prospective students must submit evidence of good health and described in the admissions package.
5. Applicants must be sponsored by a U.S. citizen residing in Okaloosa or Walton County. The sponsor must provide a letter stating the extent of responsibility he/she will assume for the applicant including arrangements for housing and health insurance. The college does not provide housing.

A non refundable application fee of \$15.00 MUST be submitted (in U.S. dollars) in order to process the application.

The United States Immigration and Naturalization Service (INS) regulations require that foreign students enroll in a full-time course of study during two of the yearly semesters. INS regulations also restrict work opportunities for such students.

## **CONDITIONAL ENROLLMENT**

A student may apply for Conditional Enrollment when the admissions forms have been completed but other documents are yet to come. This is at the discretion of the Director of Admissions.

One of the opportunities available to high school seniors about to graduate is concurrent enrollment at OWCC for the Summer Semester/Term 1. Under this specialized conditional enrollment program graduating high school seniors may enroll in courses at the college during May of the year they are to graduate.

An applicant who is permitted to attend in a "Conditional Enrollment" status will be entitled to register for a maximum of one (1) semester or term to allow for the receipt and acceptance of all required admission forms and related documents. During this time, any course credit "earned" will not be recorded or released until all outstanding forms and documents have been received and the applicant is fully admitted to the college. Registration normally will be permitted only on the last day of regular registration on a space available basis.

Conditions attached to any enrollment must be satisfied before the end of the semester in order for the conditional enrollee to become fully admitted to the college. No grades or transcripts will be released for any courses in which the applicant is enrolled. The applicant will not be permitted to register for any subsequent semesters or terms until all admission requirements are met. Should data received cause the applicant to be inadmissible, actions taken will be based on that data and not the student's performance while on conditional enrollment.

## **CONTROLLED ADMISSIONS\***

The college reserves the right to deny admission for the lack of classroom space and facilities or such other conditions as may limit enrollment. The following applicants are denied routine admission to the college:

1. With the exception of a violation of a non-criminal traffic infraction or misdemeanor, anyone who has been in violation of any federal or state law within the twelve-months preceding application must petition the Admissions Office relative to admissions to OWCC.
2. Anyone under separation from OWCC or any other educational institution for non-academic reasons.
3. Anyone who does not meet the requirements for entry into a specific program.

Such students shall be considered for admission only upon a written petition to the Admissions Committee. Applications should be submitted no later than two (2) weeks prior to the start of any given semester. Admissions Committee recommendations for favorable action on such petitions are subject to approval by the president or his designee.

\*Applicable to all enrollees (college credit, noncollege credit, full-time, part-time, new and returning).

## **FLORIDA CRIMINAL JUSTICE TRAINING CENTER NUMBER 21. OWCC**

Florida Statute 943 provides for the establishment of criminal justice training schools as approved by the Florida Criminal Standards and Training Commission. Each criminal justice training school approved by the Commission shall obtain from the Commission a Certificate of Compliance, with the rules of the Commission, signed by the Chairman of the Commission. Any training or educational courses which are taught in any criminal justice training school must first be approved in writing by the Commission and the operation and management of the criminal justice training school must be in accordance with the policies and rules of the Commission.

Okaloosa-Walton Community College reserves the right to deny admission or limit enrollment to Criminal Justice Training Center programs to any individual who does not comply with the following requirements:

1. Basic Recruit Training; Law enforcement and/or corrections basic recruit candidates: Candidates for law enforcement basic recruit programs must be sponsored by a Chief of Police or Sheriff. Candidates for corrections basic recruit must be sponsored by a County Jail Administrator or the Superintendent or other official in charge of a state correctional facility.
2. All basic recruit candidates must provide a Copy of OWCC Form 1 – Sponsorship Form, Law Enforcement/ Corrections, signed by the Agency Administrator of the sponsoring agency.
3. In-service law enforcement, correctional, and correctional probation and parole officers, to include part-time and auxiliary officers, who desire to enroll in Advanced and/or Specialized Courses offered by the Criminal Justice Training Center, must provide the Training Center with a copy of Criminal Justice Standards and Training Commission Form 15A – Training Authorization. This form must be signed by the Agency Administrator. The officer concerned must initial the appropriate block indicating his or her desire to take the course for salary incentive credit or mandatory retraining credit, but not both.

# FINANCE

## GENERAL INFORMATION

Full payment of fees is required when registering for classes at Okaloosa-Walton Community College. For your convenience, payment may also be made using either MASTERCARD or VISA credit cards. Students who have not paid their fees will not be admitted to classes. NO faculty or staff member of the college has the authority to defer fee payments. The Comptroller and the college president may grant deferments as specifically defined and limited by Florida Statutes.

## FINANCIAL ASSISTANCE

The college offers a variety of financial aid programs. Inquiries concerning financial aid should be directed to the Student Financial Aid Office.

## RESIDENCY CLASSIFICATION

To assess fees, students are classified as Florida residents or as non-Florida residents. Criteria for determining residency status are detailed in the Florida Statutes and the administrative rules of the State Board of Education. Information for Residence Classification and Residency Declaration forms are available in the Registrar's Office. Completed Florida Residency Declaration forms are required of all new students.

A student's "residency classification" is determined at the time of initial registration. A non-resident student may petition the Registrar for a change in residency status after establishing residency in Florida as defined by law. To petition, students should complete and submit a new Florida Residency Declaration form.

Active-duty military personnel (including dependent members of their immediate families) stationed in Florida are classified as Florida residents.

Providing false residency information is a violation of Florida state law and could result in disciplinary action being initiated. The college will correct the fees assessed those students who misrepresent their place of legal residence. An invoice will be issued for the increase in tuition.

## MILITARY ASSISTANCE

Active-duty military personnel who enroll in college-credit programs through base education offices may be eligible for financial assistance. The college has Military Assistance Agreements in effect with both Eglin and Hurlburt Air Force Bases. Contact the base education office for details.

## VETERAN'S BENEFITS AND ASSISTANCE

Refer to the Instructional Programs – Standards and Regulations section of this catalog.

## REFUND POLICY

Refunds resulting from course adjustments are processed at the end of the registration period. Students are responsible for completing the proper withdrawal or drop/add forms obtained from the Registrar's Office. They must also present these forms to the Business Office to complete the adjustment process. No refunds or financial credit will be granted after the last scheduled date of registration. Registration and refund dates are published each semester in the Schedule of Classes. Admission fees (except as noted below) and graduation fees are not refundable.

Refunds will be made in the form of a check and will be mailed to the student. Refund amounts will be reduced by unpaid student loans owed to the college.

Full financial credit will be granted for cancelled classes. Students can select alternate classes to which the fees can be applied. A refund will be processed automatically if replacement classes are not selected. The admission fee will also be refunded when a first semester student credit class is cancelled in its entirety and no alternate classes are selected.

Any refunds for dropping classes after the end of the last day of registration are implemented through the Vice President for Administrative Services' office. Refunds are authorized for administrative errors, for change of status from out-of-state to in-state (as confirmed by the Registrar), and for the death of a student during the term of current enrollment. Refunds may be made until mid-term for the following: serious illness or incapacity (confirmed in writing by a physician) or for transfer of military personnel and dependents (confirmed by military orders). Refunds are NOT authorized for changes in work schedules or for enrollment status changes due to illegal activities.

## **DISHONORED CHECK POLICY**

Checks returned by the bank will be processed as follows:

1. The student will be notified by certified mail that their check was dishonored by the bank. A \$20 return check charge will be applied to the student's account.
2. The student will have seven calendar days to pay for the check and the return check charge. Payment must be in the form of cash or certified funds. Failure to make the payment will result in cancellation of enrollment.
3. Reinstatement after enrollment cancellation will be considered only after full payment.
4. Students who frequently issue bad checks will be subject to disciplinary action even though their checks have been paid. The college may also suspend their check writing privileges.
5. The college will forward unpaid dishonored checks and related information about the student to a collection agency after 30 days.

## **STUDENT LOANS**

The college offers students a short-term, no-interest loan program to assist in the payment of fees. Additional details on the loan program are contained in the Financial Aid section of this catalog.

Students are required to repay loans in no more than two installments at specified intervals. Thirty-five percent of the total fees must be paid at the time of registration (subject to change as announced in the Schedule of Classes). A three percent, non-refundable, loan processing fee is assessed on all loans.

The College Student Loan program approved by the District Board of Trustees requires that EACH payment be made by the designated date. Students not meeting their scheduled payment dates will be administratively withdrawn from all their classes. Students will be considered for reinstatement within a limited time period only after paying the FULL loan amount .

Students withdrawn from their classes are not released from the obligation to repay their loans. All loans that remain unpaid after the final installment due date will be referred to a collection agency.

A student who does not comply with the terms of the loan program will lose the right to receive future loans.

## **FINES, PENALTIES, AND INDEBTEDNESS**

Students can avoid being assessed fines and penalties by becoming familiar with established policies and procedures contained in this catalog. The Student Handbook is an additional source of important information. Failure to comply with the college's regulations can result in fines being assessed. All unpaid debts with the college will result in grades, transcripts, diplomas, certificates, and other official documents to be withheld. Students will also not be allowed to re-register until all debts are paid in full.

## **PARKING FINES**

Operating a private vehicle on the OWCC campus is a privilege and not a right. Individuals who show poor judgement or lack of consideration for the rights and safety of others may have this privilege revoked. Violating the college's parking regulations can result in a \$10 parking ticket or the vehicle being towed at the owner's expense. Repeat offenders are subject to disciplinary action by the college.

Complete parking and traffic regulations are published in the Student Handbook.

## **FEE CHANGES**

All fees are subject to change without notice.



*Adult Education Instructor Doris Johnson works closely with her students at the OWCC Chautauqua Center in DeFuniak Springs.*

## FEE SCHEDULE (PER SEMESTER)\*

Admissions Processing Fee .....\$15

Required for all applicants seeking admission to OWCC college-credit courses for the first time. This is a one-time charge and is not refundable except as outlined in the section titled "Refund Policy".

Graduation Application Processing Fee .....\$15  
(Non-refundable)

Registration for Florida Resident Students per semester credit hour and/or per semester credit hour equivalent\*\*

Advanced & Professional .....	\$26.78
Postsecondary Vocational .....	\$26.78
Postsecondary Adult Vocational .....	\$13.60
Supplemental Vocational .....	\$24.72
Adult General Education:	
Adult Basic and Adult Secondary .....	\$13.60***
College Preparatory .....	\$26.78
Vocational Preparatory .....	\$13.60***

Recreational & Leisure .....At Full Cost  
of Instruction

Registration and Tuition for Non-Florida Resident Students per semester credit hour and/or per semester credit hour equivalent)\*\*

Advanced & Professional .....	\$107.12
Postsecondary Vocational .....	\$107.12
Postsecondary Adult Vocational .....	\$54.40
Supplemental Vocational .....	\$98.88

Adult General Education:

Adult Basic and Adult Secondary .....	\$54.40***
College Preparatory .....	\$107.12
Vocational Preparatory .....	\$54.40***
Recreational & Leisure .....	At Full Cost of Instruction

Student Financial Aid Fee .....5% of resident per credit hour tuition

Laboratory and Special Tuition Fees .....\*\*\*\*

Returned Check Charge .....\$20

College Student Loan Processing Fee .....3% of amount borrowed (non-refundable)

GED Test

Total Test Battery .....	\$25
Individual Test Re-Takes .....	\$5
Writing Test Re-Takes .....	\$6

Special Service Charges .....At Cost  
(Lock and locker rentals, etc.)

Comprehensive Examination Testing Fee:

100 percent of the normal Resident or Non-Resident course fee (excluding any lab fee) due and payable before the test is administered.

Directed Independent Study Course Fees:

All regular fees apply to DIS courses in addition to a special fee of \$25 per credit hour which would be assessed for each registration in specially designated sections.

\* Subject to change. Fees for each enrollment period are published in class schedules. These fees apply whenever applicable, except: (1) courses in which complimentary instructional services or equivalent program costs are provided by appropriate persons, agencies or organizations; or (2) when specifically waived by the Board of Trustees .

\*\* Registration and tuition fees do not include the student financial aid fee.

\*\*\* This fee will be assessed for students with high school diplomas who enroll in Adult General Education, Vocational Preparatory Courses, but enrollees without a high school diploma or equivalent are exempt.

\*\*\*\* Laboratory and special tuition fees are to cover unique costs related to any given course. The fee amount is determined course-by-course based on costs for each. A schedule of fees is on file in the Business Office and will be available during registration for each semester.

### COST SUMMARY

The range of basic charges for a typical full-time college-credit student, per semester, registered for 16 semester hours:

#### Florida Resident

Fees .....	\$473.40
Books and Supplies .....	\$250

#### Non-Florida Resident

Fees .....	\$1,758.84
Books and Supplies .....	\$250

Food, housing, and travel costs depend upon the student's habits and circumstances.

# STUDENT SERVICES

The office of Student Services is the "adjusting link" between the student and the college. Through its programs and services, it tries to enhance the teaching and learning process at Okaloosa-Walton Community College. Student Services also supports those extracurricular activities that add to the quality of student life. All of its programs, services, and activities are intended to support the goals outlined in the college's purpose statement. Student Services is committed to maintaining a close relationship with all other departments within the college, and the common goal is student success.

## ACADEMIC ASSISTANCE

Academic advising is available to help students make academic decisions. This service is provided by faculty, counselors, and at the centers, by educational advisors. Upon declaring a major area of study, each student is assigned a faculty advisor. This person is responsible for providing academic advice about the declared major. Students are encouraged to schedule an appointment with their advisor at the earliest opportunity.

For students who have not chosen a major, experienced college counselors and educational advisors are available to help make that choice. Counselors are located in the Student Services, "C-1" Building on the Niceville campus. Educational advisors are located at each of the centers. An appointment is advisable, but walk-ins will be served if possible. These services are intended to insure that each student has the opportunity and the information to decide what is best for them.

The **Learning Skills and Writing Laboratory** provides help to students who want to improve their abilities in writing, reading, study, and subject matter areas. Participation in this program is arranged by the student, a faculty advisor or a counselor. Use is voluntary, however, a counselor or faculty member's recommendation should be seriously considered by the student. This lab is located on the north mezzanine of the library.

The **Academic Success Center** is located in the North Mezzanine of the Learning Resources Center, Room E-148. The Center provides learning support programs consisting of tutoring in most subjects, writing assistance, CLAST (College Level Academic Skills Test) review, tutoring for learning disabled students and students with English as a Second Language (ESL) and collaborative learning sessions for several students needing assistance in the same area. A computer equipped foreign language lab is available for students needing help in learning foreign languages. Tutoring is on a one-to-one basis at no cost to the student. Assistance is available on a walk-in basis, however, students are encouraged to make an appointment. For more

information call the Academic Success Center at 729-5389.

The **Math Laboratory**, which is located in the Math-Public Safety Building, ("L"), Room L-131, is open to all students who need additional help in mathematics. The hours are posted on the lab door.

## CAREER PLANNING ASSISTANCE

Students who are undecided about their future career plans are encouraged to make an appointment with their faculty advisor, educational advisor or a counselor to begin the selection process. The next step should be to visit the Career Information Center in Student Services "C-1" building on the Niceville campus to explore the resources that are available. CHOICES is an easy-to-use computer program that will aid in career identification based upon personal answers. Other resources include career interest testing, research in the Center's career materials, or additional personal counseling. Research indicates that students who have made career decisions are more likely to be academically successful than those who have not.

## GOVERNANCE

Campus governmental processes are shared by elected and selected members of the faculty, student body, administration, and college staff.

The **College-Wide Council** provides input into the governance and decision-making processes of the college. It is responsible for advising and recommending programs, policies, and approaches to the college's president. Part of the membership is elected, and the rest are selected because of their job responsibilities or elected position. The President of the Student Government is a member and represents the student body.

The **Student Government Association** represents the student body of the college. Every student of OWCC is a member of this association. The governing body of the SGA is the Student Senate. Senators are elected to serve one year terms. They are responsible for making and implementing decisions concerning monies allotted for student activities. Projects in the past have included buying picnic tables, game room equipment, public telephone for the students, equipment for student use at the Centers, the monitor system in the Mall, and table games for check-out use. They sponsor and staff picnics, movies, dances, entertainment, food drives for the needy, blood drives, and chili suppers for the night students.



All students are encouraged to support their SGA. Any student who is interested in assisting with these activities is encouraged to run for office. The SGA Senate is housed in Room K-136 in the College Mall. The SGA President can be reached at telephone extension 786 in his/her office.

The **Inter-Club Council** promotes unity and cooperation among the recognized student organizations of the college. This council is responsible for coordinating activities and competition among the various student organizations. Members of the council are the chief officers of all student organizations. The Vice-President of SGA is the presiding officer.

The **Student Traffic Court** will adjudicate appeals of parking violations for students. If a student requests the Dean of Student Services to overturn a parking ticket and is turned down, then he/she may appeal. This appellate group will review the circumstances and recommend to the Dean that the ticket be overturned or the decision upheld. Students may pick up an appeals packet from the office of the Dean of Student Services or from the Student Activities office (K-136) on the Niceville campus.

## HEALTH SERVICES

**First aid and emergency services** are available to students by qualified college personnel during the weekdays and evenings. On weekends, the security force should be contacted at 729-5335 or ext. 335.

**AIDS information and Counseling** will be provided by a counselor, Dianne Avillion, in Student Services, Building "C"-1. The college recognizes that information is the key to prevention of this disease. Pamphlets and books are available in several locations around the campus. Every student is encouraged to make use of this information to protect themselves and others. Contact with the AIDS counselor is confidential. Students with AIDS, ARC, and HIV-positive test results are strongly encouraged to contact Dianne Avillion during the first week of classes. She can be reached at extension 372 or 729-5235.

**Alcohol and Drug Abuse information** is available to all students from a counselor located in Student Services. Call Ms. Avillion at 729-5235. The physical and emotional risks associated with substance abuse can be very severe. This counselor maintains information on local treatment programs and their locations. The college will refer for prosecution any violation of local, state, or federal laws.

**Students are warned that the use, manufacture, distribution, sale, or possession of alcoholic beverages or illicit drugs on campus or at any college-sponsored event or activity is prohibited by college policy. Violation of this policy will subject a student to disciplinary action and possible loss of financial aid.**

## JOB PLACEMENT SERVICES

Students looking for full time employment after graduation from technical programs can be helped by the faculty. Part-time off-campus job openings are kept on file in the Financial Aid office in the Student Services Center ("C-1" Building).

Prospective employers of students are required to file a written assurance of non-discrimination on the basis of age, color, creed, handicap, marital status, national origin, race, religion, or sex before their job openings are listed.

## ORIENTATION

**New student orientation** is offered to all new students during each semester's registration. During orientation, students receive valuable information about college policies, procedures, and academic programs. Students will also receive help in selecting courses.

**Freshman Seminar** is a course designed to orient entering AA program students to OWCC. This seminar will assist students in developing their study skills. The student will be aided in choosing a major based upon reasonable career choices. One goal of the course is to help students become familiar with the requirements of the CLAST (College-Level Academic Skills Test).

**Freshman Seminar** is recommended for all entering AA degree students.

## SERVICES TO STUDENTS WITH SPECIAL NEEDS

OWCC is committed to providing equal opportunities for education to all students. A counselor is available through the office of Disabled Student Services in the Student Services Office on the Niceville campus to assist students with disabilities, limited English proficiency, and with impairments or special needs. In accordance with the Florida State Board of Education Rule 6H-1.041, students with disabilities may present support documentation and request reasonable substitution for admission and/or graduation requirements.

Specialized services are available to students whose disability prevents them from participating fully in classroom activities. Students who identify themselves and provide documentation of their disability may be eligible for support services such as note-takers, scribes, untimed testing, readers, or interpreters.

Disabled students should contact the Office of Student Services on the Niceville campus or other college locations prior to the beginning of each semester for assistance in registering and for information concerning services that may be available, including maps indicating campus accessibility routes.

**All students are encouraged to make known any health problem or disability that may affect their presence at OWCC.** All information is kept confidential. Identification of a condition may be completed by filling out the proper form in the Office of Student Services, Registrar's office, or the Eglin, Ft. Walton Beach, Hurlburt or DeFuniak Springs Center.

Elevators are located in the Learning Resources Center and the Administration Building to accommodate students. The entrance to the elevator in the Learning Resources Center is on the east side. The elevator in the Administration Building may be accessed from either entrance.

The college has several **Telephone Device for the Deaf (TDD)** numbers to assist the hearing impaired. Anyone wishing to use a TDD to communicate with the college is encouraged to call 729-5236 during the day, or 729-5276 during the evening. Student Services' TDD number is 729-5236. The OWCC Business office TDD number is 729-5355. The off-campus centers' TDD numbers are: Eglin, 729-5343, Ft. Walton Beach Campus, 863-6504, Chautauqua Center, 892-8100 and Crestview Center, 689-7911.

Disabled or other students with special needs should contact the designated counselor located in the Student Services Center. Information is available by calling 729-5372.

Persons who feel that the college did not accommodate or respond to their particular disability requirements are encouraged to show the college the particulars of that complaint. Students should discuss the problem with the Disabled Student Services Coordinator located in the Student Services Building (C-1) on the Niceville campus or the center or campus administrator at other locations. Copies of the "Accessibility Grievance Procedure" are posted on bulletin boards at all centers and campuses.

## STANDARDIZED TESTING

**College Level Examination Program (CLEP)** tests are a nationally developed program for credit-by-examination. Credit may be granted for scores at or above the established criterion score on approved tests. Fees are set by the College Entrance Examination Board. Tests for this advanced placement mechanism can be arranged through the Coordinator of Testing, phone 729-5234 or ext. 676.

## STUDENT LITERACY CORPS

The **OWCC Student Literacy Corps** is a service and learning program for students which combines a three credit hour course, HUS 1400 **Peer Advising**, with hands-on experience tutoring

in literacy programs. Students have a choice of working with secondary or adult students engaged in literacy training activities. A Student Literacy Corps tutor is a special type of volunteer. The tutor who is seeking credit is an individual committed to helping fellow students enrolled in basic skill programs to reach their educational goals and to assist them in developing career plans. By becoming a member of the Student Literacy Corps, college credit students will develop teaching and tutorial skills, gain multi-cultural awareness, help others in a personal way, and build their personal resume.

Attendance requirements for the Student Literacy Corps consists of 15-hours of lecture to orient the student to literacy issues, tutoring techniques, learning styles and profile of the adult learner and the at-risk youth.

For additional information and to join the Student Literacy Corps, contact the Literacy Center located in the Continuing Education Building. Call 729-5387 or 729-5344.

## STUDENT ATHLETICS

OWCC is an active member of the National Junior College Athletic Association (NJCAA) and the Florida Community College Activities Association (FCCAA) which is composed of all public community colleges in Florida.

**Intercollegiate Sports** at OWCC operate under the rules and regulations of NJCAA and FCCAA. Varsity athletes enjoy the privilege, honor, and social distinction of representing the college in the field of athletic competition.

Representation of the college is open by competitive selection to all students provided they meet the eligibility requirements of the FCCAA. Intercollegiate sports at OWCC are basketball for men and women, baseball for men, and fast-pitch softball for women.

**Intramural and Extramural Activities** at OWCC include team sports such as flag football, volleyball, softball, tennis, racquetball, arcade games, and basketball as well as individual recreation such as chess, backgammon, pool, golf, and bowling. Classes, clubs, organizations and independent groups are encouraged to form teams and compete.

Awards are given to winning teams and players. The highest awards each year receive the President's High Point Plaques. These are presented to the woman and the man with the highest number of points. Often, the winning teams in basketball, volleyball and flag football will meet other winning teams from colleges within Region I to determine an overall winner.

Times, schedules, and places of meeting for activities are posted on the bulletin boards located in the College Mall.

## **STUDENT ORGANIZATIONS**

The college has chartered several student organizations. These include general and special interest groups, honor societies, service clubs and social groups. These organizations cover a wide variety of interests and activities. Membership is open to all students who qualify, without regard to age, color, creed, handicap, marital status, national origin, race, religion or sex, except for those particular groups which are selective on the basis of scholarship. **All groups operate under the rules printed in the "Student Organizations" portion of the "Students Rights and Responsibilities" section of this chapter.**

The following groups are recognized OWCC student organizations:

**Phi Theta Kappa** is a national honor society whose goal is to honor students who have attained a high scholastic standing, and to provide them with the opportunity to congregate and sharpen their intellects. Service projects and social activities are available to the membership.

**Student Christian Fellowship (SCF)** promotes high standards of Christian character and provides the opportunity for spiritual growth. Membership is open to all students.

**Music Theatre** produces at least one Broadway-style musical annually. Participation is open by audition to all students and members of the community.

**Outing Club** membership is open to all students, faculty, and staff members. The group organizes various outdoor activities and promotions.

**Proscenium Playhouse** is the drama group of the Fine and Performing Arts Department. Its goals are to foster an interest in and an appreciation of the theatre arts, to produce plays, and to provide an outlet for the creative abilities of the students and community members.

**Artista** is dedicated to the promotion of the visual arts on campus. Artista fosters interest and participation in student-related art activities. Membership is open to all students.

**Baptist Campus Ministry** is open to all students for the purpose of guiding them in Christian witness and fellowship.

**Black Student Union** strives to promote black awareness and to be of service to the college and the community. Membership is open to all students.

**College Republicans** provides an opportunity for OWCC students to find political expression and recognition through association with the Republican Party. It is open to all students.

**OWCC Community Chorus** is open to all students, staff, and interested members of the community. The chorus performs major choral compositions during the fall and spring semester of each year and maintains a membership of sixty or more auditioned singers.

**Delta Psi Omega** is a large, national honorary fraternity whose purpose is to stimulate interest in dramatic activities.

**Rock and Jazz Ensemble** in big band, combo and rock groups is open by audition to any student instrumentalist who wants to develop professional performance abilities. Must have some experience in high school bands, etc.

**The Northwest Florida Symphony Orchestra of OWCC** is open to all OWCC students, staff, and interested members of the community who have a demonstrable performance skill with an orchestral instrument. The Orchestra draws its membership of over sixty players from throughout the Panhandle and South Alabama.

**Phi Lambda Alpha, Alpha Chapter**, is an honorary fraternity whose primary purpose is to stimulate interest in the Arts and Humanities.

**OWCC Show Choir** is a small, by audition-only mixed choir, comprised of college students who are enrolled full-time. The group specializes in up-tempo, contemporary, entertainment oriented music ranging from jazz tunes of the 40's to the latest pop tunes, as well as show-stopping selections from Broadway and Hollywood. Choreography is incorporated into each performance.

**Students Against Driving Drunk (SADD)** is a local chapter of the national organization that works towards raising the awareness of students and the community of the problems caused by people who drive under the influence of alcohol and other drugs. Membership is open to all students.

**Circle K** is a service organization sponsored by Kiwanis International. It is dedicated to college and community service and is open to all students. The Niceville Kiwanis Club is the local sponsor.

**Reader's Theatre** is a popular form of interpretive reading for group participation. They conform to no single style and invite imaginative experimentation. Membership is open to all students.

**Phi Beta Lambda Business Education Fraternity** is designed to assist students enrolled in business programs to develop vocational competencies and a sense of civic responsibility.

**Madrigals** is a small, by audition-only, mixed choir. The group specializes in acappella music from the Renaissance to the modern.

**Environmental Club** is dedicated to creating awareness of the importance of protecting the environment.

There are other chartered organizations which are not currently active such as **Distributive Education Clubs of America, Raider Review Newspaper, Jefferson Democratic Association, Raider Sailing Club, and Veterans.** If you are interested in reactivation of one of these organizations, check with the Student Activities Office in the College Mall to learn how this may be accomplished.

Students are encouraged to participate in student activities and enjoy them as long as they do not interfere with their studies.

## STUDENT HANDBOOK

*The Student Handbook* is a small booklet containing important dates and where services can be found. Under general information are the operating times for libraries, the bookstore, and learning labs. *The Student Handbook* is usually received at New Student Orientation, and it may be obtained from any center or from Student Services. Every student is advised to obtain one.

## STATEMENT OF STUDENT RIGHTS AND RESPONSIBILITIES

Okaloosa-Walton Community College serves all persons legally out of grades K-12 without regard to age, color, creed, handicap, marital status, national origin, race, religion, or sex. However, the college reserves the right to deny admission to any program for applicants categorized in the section on "Controlled Admissions" in the current college catalog. By applying for admission to Okaloosa-Walton Community College, the student agrees upon enrollment to abide by college policies and regulations published in its policy statements, current catalog, official manuals, and publications. Students are expected to be committed to the common good of the college community and to comply with local, state and federal law.

## CLASSROOM ACTIVITY

The college recognizes that a thoughtful and reasoned search for truth can be conducted only in an atmosphere free of intimidation and coercion. Students are expected to respect the rights and welfare of all members of the college community. In their pursuit of an education, students are expected to prefer fact to opinion and to exercise common sense, good taste, and applied reason when testing their knowledge.

Students are free to take reasonable exception to data and views offered in the classroom and to reserve judgment about matters of opinion, but they are responsible for satisfying the requirements of any course for which they are enrolled. **So long as it is consistent with the goals and established policies of the college, the instructor has final authority in all matters relating to course content, grading practices, and classroom procedures.**

Because the awarding of course grades is the responsibility of the instructor, it is essential that faculty members keep students informed of their progress in each course. A student has a right to a course grade that represents the instructor's professional judgment of the student's performance in the course, without personal prejudice.

If a student believes that he/she has not been graded fairly in a course, an informal appeal may be made to the instructor. If a complaint is not resolved to the student's satisfaction, an appeal without prejudice to the student's position may be made to the department or division chairperson. The next level of appeal is to the Vice President for Instruction who may, if it is deemed advisable, refer the matter to an ad hoc hearing committee to assist in evaluating the appeal. Any further appeal may be made to the President, whose decision shall be final.

A student has a right to protection against the improper disclosure of information concerning grades, beliefs, or character which an instructor acquires in the course of the professional association with the student.

## ATTENDANCE/CLASSROOM

Students are expected to attend all of their scheduled classes. The effect of absences upon grades is determined by the instructor who may recommend to the Vice President for Instruction a withdrawal grade whenever absences become excessive. **Three consecutive day class absences, two consecutive evening class absences, or three absences in a month will be reported to the Registrars Office as excessive. Further, each time a student has been tardy three times to a class, it will count as one absence.** Arranging to make up work missed because of legitimate class absence (such as hospitalization, death in the immediate family, or other nonrecurring extenuating circumstance) is the responsibility of the student in cooperation with the instructor.

## STUDENT BEHAVIOR

Students are expected to assume full responsibility for their actions. Each member of the college community is expected to participate seriously and purposefully in college life.

## STUDENT RIGHT-TO-KNOW GRADUATION RATES

Public Law 101-542, the Student Right-to-Know and Campus Security Act as amended in 1991, requires colleges to make known to currently enrolled and potential students and employees the completion or graduation rate within 150% of the expected completion time of certificate or degree-seeking, full-time undergraduate students of OWCC. A cohort will be established each fall semester of those students, and they will be tracked for 150% of allotted time to completion. Results of the Fall term cohort (first-time in college full-time students) are published annually in percentages as indicated below.

### 1991 COHORT (Established Fall Semester 1991)

#### Degree Seeking Members

	Fall 1991	Fall 1992	Fall 1993
Number of Enrollees	490	302	167
Percentage of Enrollees	100%	61.63%	34%
Percentage Persisters	0%	61.63%	34%
Percentage Completers	0%	0%	15.51%
Percentage of Elapsed Allotted Time to Completion	0%	50%	100%

#### Certificate Seeking Members

	Fall 1991	Fall 1992	Fall 1993
Number of Enrollees	7	1	1
Percentage Enrollees	100%	14.25%	14.25%
Percentage Persisters	0%	14.25%	14.25%
Percentage Completers	0%	0%	14.25%
Percentage of Elapsed Allotted Time to Completion	0%	75%	150%

## SUMMARY OF REPORTED CAMPUS CRIMES

This information is provided to all students and employees each year beginning with this report, in compliance with The Federal Student Right-to-know and Campus Security Act. Questions about this report or Campus Security in general may be directed to the Director of Physical Plant Department or the Dean of Student Services.

#### A. On campus crimes reported to Physical Plant Department by major category:

	1990	1991	1992
1. Homicide Offenses	0	0	0
2. Sex Offenses, Forcible	0	0	0
3. Robbery	0	0	0
4. Aggravated Assault	0	0	1
5. Burglary/Breaking & Entering	3	6	3
6. Larceny/Theft Offenses	16	10	16
7. Motor Vehicle Theft	0	0	0

11/30/93

## STUDENT DISCIPLINE

Academic and personal behavior of OWCC students shall be governed by policies contained in the college catalog, the Student Handbook, such other policies as may be approved by the Board of Trustees on recommendation of the President and by pertinent provisions of Florida Statutes and FAC Rules. Any act or behavior by a student which tends to interfere with or otherwise disturb the orderly conduct, process, functions and/or interests of the college is prohibited. Such acts and behaviors include but are not limited to the following:

1. Cheating in any form, including plagiarism;
2. Gambling;
3. Theft, vandalism or destruction of college property, or property of members of the college community;
4. Falsification of personal or college records;
5. The use, manufacture, distribution, sale, or possession of alcoholic beverages or illicit drugs on campus or at any college-sponsored event or activity;
6. Violence, including but not limited to sexual assault, robbery, murder or battery against any member or guest of the college community;
7. Hazing; and Harassment.

Instances of prohibited student behavior will be referred to the Dean of Student Services for resolution.

A member of Student Services will be appointed to make inquiries into the circumstances of the matter to determine if it has been handled through the proper channels. The inquiry will be completed within seven (7) working days of the submission date. This person may recommend that the matter be dismissed, settled informally, or be the subject of formal charges.

All reports of sexual assault and/or harassment are to be treated as confidential. The member of the college staff receiving the complaint should treat the victim with respect and consideration. It is important that confidentiality be extended to the accused as well as the victim. All persons involved in this procedure are directed not to discuss the matter except with college personnel involved in the process, attorneys for the victim and/or the accused, law enforcement personnel and other authorized agencies.

Informal settlement will be at the discretion of the Dean of Student Services who may do one or more of the following: give oral or written warning and/or admonition; require restitution or counseling. The informal settlement will take place within seven (7) working days of the inquiry recommendation.

Formal charges, in writing, will be prepared by the Dean of Student Services within five (5) working days and presented to the accused student. The charges will include:

1. The accused student's name, address, and social security number.
2. A description of the alleged violation that includes dates, times, and places.
3. The names of any witnesses and a description of any physical or written evidence that was known at the time that formal charges were prepared.

At the time of notification of formal charges, the Dean of Student Services will offer the student his/her choice of hearing settings:

1. An administrative hearing which will be conducted by the Dean of Student Services who will decide guilt or innocence and the appropriate action or sanction: dismissal of the charges, placing the student on disciplinary probation, or recommending to the president suspension or dismissal.
2. A Student Conduct Committee hearing which will decide guilt or innocence. The committee will be comprised of the Dean of Student Services (Chair), two other members of Student Services, two faculty members appointed by the Vice President for Instruction, and two students appointed by the Dean of Student Services upon recommendation of the Student Government Association President. After the presentation of evidence (against and in defense of the student), if the committee decides that there is clear and convincing evidence that the student is guilty, it will recommend the action or sanction to be taken. If the committee decides that the student is not guilty, it will recommend that the charges be dismissed. The Dean of Student Services will make the final decision and recommendation, then inform the student of the decision, the procedures of review and the grounds for appeal.

The Vice President for Instruction will review the records, evidence and findings of all hearings before the recommendation for suspension or dismissal goes forward to the president. If the vice president decides that published disciplinary procedures were not followed, the matter will be returned to the Dean of Student Services for rehearing.

Students who are found guilty in either hearing setting may, within seven (7) days of notification of the findings and recommendations, appeal in writing to the Vice President for Instruction on the basis of one of the following:

1. The discovery of new evidence.

2. The recommended penalty would impose unusual and severe hardship on the student.
3. Published disciplinary procedures were not followed.

The Vice President for Instruction will hear the appeal and do one of the following:

1. Uphold the original hearing findings, and forward to the president:
  - a. the recommendation to suspend or dismiss, or
  - b. recommendation to impose a lesser sanction.
2. Based upon new evidence, dismiss the charges, or
3. Return the matter to the original hearing setting for rehearing if published disciplinary procedures were not followed.

A student may appeal the decision of the Vice President for Instruction to uphold the original findings and recommendations only on the basis of new evidence. This appeal must be submitted to the president, in writing, within seven days after notification to the student of the Vice President for Instruction's decision.

No student shall be suspended or dismissed from OWCC without approval by the president. The president shall have the authority to temporarily suspend, while awaiting the disciplinary procedures outcome, any student whose behavior is judged by him to be detrimental, or potentially detrimental, to the college community.

Upon recommendation, and after implementation of the hearing process, a student may be suspended or dismissed by the president for behavior which is prohibited or otherwise unacceptable. The Board of Trustees shall be advised of dismissal actions at its next regular meeting following such actions.

Disciplinary probation requires compliance with the following restrictions and obligations:

1. Conformance with all college policies, rules, and regulations pertaining to student behavior as specified in the current college catalog, Student Handbook, or any other official college publication .
2. Avoidance of involvement in actions or activities which could be considered disruptive to the educational process or detrimental to the health, welfare, and safety of any member of the college community.
3. Avoidance of participation in any student extracurricular organized activity.
4. Reporting on a scheduled basis for appropriate counseling sessions with an assigned college counselor.

5. Remaining in full compliance with the conditions of applicable court-imposed probation/parole.
6. Reporting on a scheduled basis to the Dean of Student Services for review of compliance with the terms of disciplinary probation.

Disciplinary suspension terminates a student's enrollment at OWCC for a specified period.

Dismissal separates a student from the college for an indefinite period with readmission subject to the recommendation of the Admissions Committee and the approval of the president.

Students who become ineligible for enrollment because of disciplinary action may not continue their education through any programs, activities, or offerings of Okaloosa-Walton Community College until such time as they may be readmitted to the college.

### **STUDENT GRIEVANCE PROCEDURES**

Okaloosa-Walton Community College student grievance procedures are designed to provide effective means for resolving legitimate issues that are subject to the grievance process. State Board Rules and College Policies are not grievable; only the application or interpretation of rules or policies may be grieved.

### **RESOLUTION OF GRIEVANCES**

Any student who believes that he/she has been done an injustice through the action of another student, a college employee, or other person acting for the college may initiate a grievance under these procedures.

OWCC's student grievance procedures apply to all complaints on the part of students which may arise in matters of instruction and general student services when they involve rights provided for under the college's Equal Access/Equal Opportunity Plan and the Florida Educational Equity Act and when they directly affect the personal interests and well-being of individual students.

Complaints which do not directly affect the personal interests and well-being of individual students and which are not otherwise covered by these procedures shall ordinarily be referred to the Dean of Student Services for resolution.

The president of the college shall be the final arbiter where a dispute exists as to whether a particular matter is subject to coverage by these procedures. In making his decision, the president will interpret the coverage of these procedures liberally, denying their application only when the matter in question clearly concerns issues of rule or policy in which the complaining party has no direct interest, where there is good reason to believe that

a grievance has been brought in bad faith for political or similarly inappropriate reasons, or for circumstances in which use of these procedures would clearly endanger their effectiveness as an instrument for the redress of grievances.

### **THE INFORMAL GRIEVANCE PROCEDURES**

The college's informal student grievance procedures shall be implemented in the following sequence:

1. The aggrieved student shall first discuss his/her complaint with the instructor or faculty advisor concerned for resolution.
2. If the grievance remains unresolved, the student should refer it to the appropriate department or organizational unit head for resolution.
3. If the circumstances of the grievance preclude the use of steps 1 and 2, or if the department or organizational unit head does not resolve the grievance within ten (10) working days, the student should discuss the grievance with the Dean of Student Services, who will bring the matter to the attention of the president of the college.

If the grievance resulted from violation of college policies, the College Equity Plan, or FAC Rules, the president shall take or cause to be taken appropriate measures to ensure compliance with the policies, statutes or rules, and resolve the grievance.

If the grievance involves a question of judgment or opinion not covered by college policies, by the College Equity Plan, or the FAC Rules, the president or his designee shall counsel with the student, the faculty advisor, or the department or organizational unit head, and the appropriate principal administrator, in an endeavor to resolve the grievance.

### **THE FORMAL GRIEVANCE PROCEDURE**

If a grievance is not resolved by the informal procedure, the aggrieved student should submit a request, in writing, to the President of the College via the Dean of Student Services for a formal student grievance hearing. It shall set forth the nature of the grievance, the person(s) involved, and the resolution desired. It shall also include the nomination of one disinterested SGA Senator who is willing and available to serve as a member of the student grievance hearing committee.

## STUDENT ORGANIZATIONS

If the request for a hearing is disapproved, the president shall state the reasons in writing. If approved, he shall appoint a student grievance hearing committee composed of the following members:

1. The SGA Senator named in the original request for the hearing or a substitute satisfactory to the grievant.
2. A college employee nominated by the Dean of Student Services.
3. An additional college employee who shall be nominated by mutual agreement of the other two members, who is a regular, full-time employee, and who, with the approval of the president, shall be designated chairperson. If the two members cannot agree on a nominee for chairperson, the chairperson will be appointed by the president.
4. The Dean of Student Services or his/her designee will serve as recording secretary to the committee but shall have no vote. If the grievance involves an equity issue, the College Equity Coordinator shall appoint a representative to serve as an advisor to the committee.

The committee shall, within seven (7) days of being constituted, meet to hear the grievance and interview such witnesses as it deems pertinent to the matter.

The committee shall report its findings and recommendations for resolution of the matter, in writing, to the president within four (4) working days of the close of the hearing.

The president shall advise all pertinent parties of his action on the grievance within three (3) working days after receipt of the committee's report.

The action by the president is final, except for cases of student expulsion, which may be appealed by the aggrieved student, in writing, to the Board of Trustees within three (3) working days of receipt of the decision. The decision of the Board in such matters is final.

## TIME LIMITS

A grievance must be filed in a timely fashion. If a student is filing a grievance, it must involve a specific event or incident occurring within thirty (30) days of filing the grievance.

## SUMMARY

Nothing in this procedure is intended to create any due process rights nor does it entitle the individual to seek redress in any court or administrative proceeding.

Students enrolled at the college are free to organize and are encouraged to join associations which promote their common interests, so long as the following apply:

1. The purposes, principles, and policies of the organization are consistent with the general philosophies and principles of the college,
2. Membership in the organization is open to all currently-enrolled college students in good standing without regard to age, color, creed, national origin, handicap, marital status, race, religion, or sex except for those particular groups which are selective on the basis of scholarship,
3. Statements of the purpose, criteria for membership, rules or procedures, and a current list of officers are filed with the Coordinator of Student Activities,
4. The policies and actions of the organization are determined only by those individuals who hold bona fide membership in the organization,
5. A faculty sponsor has been appointed by proper authority,
6. The Student Senate has recommended, and the President of the college has approved recognition of the organization, and
7. The organization is in compliance with the general and specific policies enumerated in the *Handbook for Student Organizations* and in the *Student Handbook*.



The OWCC Fine and Performing Arts Department presents several plays each year, including last year's popular performance of "Steel Magnolias."



## HAZING

Florida Statute 240.326 prohibits hazing at community colleges. "Hazing" means "any action or situation which recklessly or intentionally endangers the mental or physical health or safety of a student for the purpose of initiation or admission into or affiliation with any organization operating under the sanction of a community college, which organization is hereafter referred to as a "community college organization." Such term includes, but is not limited to, any brutality of a physical nature, such as whipping, beating, branding, forced calisthenics, exposure to the elements, forced consumption of any food, liquor, drug, or other substance, or other forced physical activity which could adversely affect the physical health or safety of the individual, and also includes any activity which would subject the individual to extreme mental stress, such as sleep deprivation, forced exclusion from social contact, forced conduct which could result in extreme embarrassment, or other forced activity which could adversely affect the mental health or dignity of the individual. For the purposes of this section, any activity as described above upon which the initiation or admission into or affiliation with a community college organization is directly or indirectly conditioned shall be presumed to be a 'forced activity,' the willingness of any individual to participate in such activity notwithstanding."

No form of hazing shall be permitted in connection with any initiations and/or activities of any college organization or group.

## HARRASSMENT

Harassment of OWCC students is prohibited.

Harassment of college employees by OWCC students is prohibited.

Harassment is considered to be any repeated or unwelcome verbal or physical abuse which causes the recipient discomfort or humiliation or which interferes with the recipient's academic performance.

**Harassment related to an individual's race, color, sex, religion, national origin, age, marital status, or physical or mental handicap is a violation of this policy.**

**Unwelcome or uninvited conduct with sexual overtones, requests for sexual favors, and other verbal or physical conduct of a sexual nature constitutes sexual harassment, including, but not limited to instances when:**

1. Submission to such conduct is made explicitly or implicitly a term or condition of a student's academic achievement, or

2. Submission to or rejection of such conduct by an individual is used as the basis for academic decisions affecting a student or college employee, or
3. Such conduct has the purpose or effect of unreasonably interfering with an individual's academic performance or creating an intimidating, hostile or offensive academic environment.

The president of the college may act directly or through a designee to investigate and report harassment claims. Due process and/or Student Grievance procedures shall be followed in connection with such claims.

## GUEST SPEAKERS

The freedoms of speech and assembly guaranteed by the first and fourteenth amendment to the Constitution shall be enjoyed by the students of the college with regard to the opportunity to hear "off-campus" speakers on the college campus. Students at the college are expected to accept fully the responsibilities that accompany the freedoms of speech and assembly which they enjoy. When inviting a guest speaker, a student organization is charged with the responsibility of making a choice that reflects the students' genuine concern for the best interests and welfare—not only of the student organization—but of the college and the community as well.

The extension of invitations to guest speakers who are not of the college community shall be governed as follows:

1. Guest speakers may be invited and sponsored only by recognized student organizations.
2. No invitation shall be extended to a guest speaker without the prior written approval of the president or his designee, the Dean of Student Services. Approval or disapproval will be based on consideration of the appropriateness and availability of times, dates, and facilities.
3. Permission to invite a guest speaker shall be requested in writing at least two weeks prior to the proposed speaking engagement by the president of the student organization sponsoring the program. This request shall contain the name of the sponsoring organization, the proposed time, date and location of the program, the expected size and nature of the anticipated audience, and the topic of the speech.

## **POSTING, CIRCULATING, AND EXHIBITING PRINTED MATTER AND FILMED MATERIAL**

Students are expected to use mature judgment and a sense of discretion in their selection, publication, display, presentation and circulation of any printed or filmed materials at any college location, and to realize that they must accept responsibility individually and collectively in the consequences of their choices on these matters. **The appearance of the college name, seal or insignia on printed matter which is not published by the college is not authorized and does not imply college approval, support, or endorsement of the contents.**

## **NOTICES**

Notices may be posted by students and recognized student organizations on appropriate bulletin boards. All such posting must be cleared in advance by the Coordinator of Student Activities to avoid congestion. This will provide the best use of available facilities. Notices and posters are not to be taped, glued, or pasted on painted surfaces or on finished wood surfaces.

The general distribution of notices is prohibited by anyone other than instructional and staff personnel in the performance of their duties or by recognized student organizations to advertise an approved event.

## **MOTION PICTURES**

Recreational motion pictures that are approved as part of a proposed student organization sponsored-event may be shown at any college location. The Director of Student Services will consider for approval, only those films rated "G" and "PG" by the Motion Picture Association of America. Any college employee may restrain the display of any unauthorized film or motion picture.

## **STUDENT PUBLICATIONS**

Student publications (which may include videotaped newscasts) are intended to foster an atmosphere of free and responsible discussion and intellectual exploration. They are a means of bringing student concerns to the attention of faculty and staff members, and of formulating student opinion on various issues at the college and in the surrounding community.

The editorial freedom of student editors entails the corollary responsibility to be governed by the canons of responsible journalism, such as the avoidance of libel, indecency, undocumented allegations, attacks on personal integrity, and the techniques of harassment and innuendo.

Student publications shall contain a statement to the effect that the opinions expressed therein are not necessarily those of the faculty, staff or student body of the college.

## **POLICY FORMULATION**

A student who wishes to suggest a change in any policy of the college should submit a written recommendation to the Student Senate for evaluation. If favorably received by the Senate, the proposal shall be submitted by the Student Senate to the College Wide Council or the appropriate standing committee/subcommittee of the college for consideration.



*OWCC faculty pride themselves in a personal approach to education and strive to give students individual attention to enhance learning and comprehension. Communications Instructor Julia Nichols assists a student during an English Composition I course held in the Communications Computer lab.*

*After studying Russian history, culture and language, OW's first foreign study course toured Russia for two weeks. One of the first stops was St. Petersburg and a visit to the Winter Palace and the statue of Peter the Great.*



*Caps are proudly pinned in place before graduation ceremonies begin. Graduation is held each spring and is the goal of all OWCC students – a milestone in their road to "Success by Degrees".*

## STUDENT FINANCIAL AID

Okaloosa-Walton Community College's mission is to serve everyone who can benefit from a college education. No one thinking of college should hesitate about applying for admission because of financial need. OWCC has a variety of financial assistance for students. The chart within this section gives a brief description of all of the programs that are available for students at OWCC and the Financial Aid Office has hand-outs available that offer more detail on the three basic types of financial aid – Grants, Loans and Work Programs. These hand-outs, along with the Application for State and Federal Financial Aid, are available either by mail, at the guidance office of any Okaloosa or Walton high school, or at any of the OWCC locations throughout the two-county area.

## PURPOSE OF OWCC'S FINANCIAL AID PROGRAM

The purpose of financial aid is to make up the difference between what you can afford to pay and the actual cost of your education. This difference is what we call a student's financial need. The amount of financial assistance a student receives is generally determined by the results of the application process and the availability of funds from federal, state, institutional and private sources. The final decision as to the types of aid received rests with the Director of Financial Aid.

Financial assistance administered by OWCC does not discriminate on the basis of race, sex, age, national origin, religion, marital status or handicap. Specific additional non-discriminatory criteria and academic standing status may be required for particular assistance or scholarships.

## COLLEGE COSTS

Okaloosa-Walton Community College's fees are designed to make college affordable for most students. Allowance should be added to these figures for room and board, personal expenses, medical insurance, transportation and supplies. Dependent students (living at home) usually have parental support, reducing direct education costs. Students should refer to the college schedule of classes each semester for offerings which involve special fees.

## PROCEDURES FOR APPLYING FOR FINANCIAL AID

Entering students seeking financial assistance should contact the Student Financial Aid Office which is located in the Student Services Center on the Niceville campus. The following procedures need to be followed when applying for financial aid at OWCC:

1. Complete the OWCC *Application for Admission* and return it to the Office of Admissions.
2. Request appropriate supporting documents for Admission (i.e. high school transcript, GED, college transcripts) as specified by the Admissions Office personnel. If you have previously attended any other postsecondary institutions, a Financial Aid Transcript must be requested and received by OWCC before the college can determine your eligibility for aid.
3. Complete the Free Application for Federal Student Aid (FASFA) packet. Packets are available in area high schools or at any OWCC location.
4. Complete the OWCC application for financial aid form.
5. After mailing the FASFA, the student will receive a *Student Aid Report (SAR)* in approximately four to eight weeks. The SAR must be reviewed by the student for accuracy, signed by the appropriate individuals, and submitted to OWCC's Financial Aid Office.
6. Additional information/forms might be requested by the Financial Aid Office (i.e. Income Tax forms) if the student is selected for a process called Verification and/or Documentation.
7. If a student's financial aid file has been considered to be "complete" then an award letter will be mailed to the student by OWCC's Financial Aid Office. The award letter must be signed and returned to OWCC's Financial Aid Office within ten (10) days from the date it is dated for the student to be eligible to receive the funds as specified in the letter.

Students needing assistance in completing application forms should contact the Financial Aid Office. Students have a right to understand how their financial aid award is determined. OWCC's Financial Aid Office is always willing to discuss financial aid decisions with students and parents to promote a better understanding of financial aid opportunities.

### **DEADLINES FOR APPLYING FOR FINANCIAL AID AT OWCC**

Applications for financial aid should be made well in advance of registration. The **PRIORITY CONSIDERATION DEADLINES** for applying for financial aid at OWCC for 1994-95 by semester are:

- Fall Semester .....April 1, 1994
- Spring Semester .....October 1, 1994
- Summer Semester .....February 1, 1995

Students not meeting the priority deadline may still qualify for financial aid but may experience lengthy delays in receiving financial aid.

The absolute deadline for determining enrollment status (i.e. part-time, three-quarter time, or full-time) is the advertised "last day to register" day within each of the three main semesters – Fall, Spring or Summer. (These dates are listed in the Schedule of Classes each semester and the calendar section of this catalog.)

All applications for the Florida Student Assistance Grant for the 1994-95 academic year must be in Tallahassee no later than the advertised deadline on the application form. All applications for the College Work Study Program and the Supplemental Education Opportunity Grant dated prior to April 1, 1994 will be given first priority in determining eligibility.

### **ENROLLMENT STATUS**

The amount of aid a student is eligible to receive at OWCC is dependent on the student's enrollment status, each semester, based on the following table:

- Full-Time  
Enrollment .....12 or more semester hours
- Three-Quarter Time  
Enrollment .....9-11 semester hours
- Half-Time  
Enrollment .....6-8 semester hours
- Less Than Half-Time  
Enrollment .....1-5 semester hours

Financial aid award status (full-time, three-quarters time, or half-time) will be based on the number of credit hours at the **END OF LATE REGISTRATION FOR EACH SEMESTER**. For award letters sent after these dates, status will be determined by the number of credit hours in which a student is enrolled at the time the award letter is sent. If not enrolled for the appropriate number of credit hours at that time, a student's award will be revised downward to reflect this change. Awards will not be revised upward if students add classes after that date.

### **STUDENT ELIGIBILITY**

#### **FEDERAL PROGRAMS**

For a student to be eligible for federal financial aid at OWCC –

- A student must be a regular student, accepted for enrollment in a **PROGRAM OF STUDY**, and
- A student must be a **U.S. CITIZEN**, or an eligible non-citizen, and
- A student must maintain a **STANDARD OF SATISFACTORY PROGRESS** and **ACADEMIC GOOD STANDING** which includes the following three factors:
  1. Satisfactory grade point average on all college work.
  2. A maximum time-frame in which the student must complete his or her educational objective, degree or certification.
  3. Progression within the time-frame towards adequate completion of coursework.
- A student must **NOT OWE A REFUND** or **REPAYMENT** on a federal grant at any institution, and
- A student must **NOT BE IN DEFAULT** on a federally-funded or insured student loan, and
- A student must have signed the following statements which are listed on the Student Aid Report and Student Award Letter:
  1. A statement of educational purpose and certification statement on refunds and defaults
  2. A statement of registration status

## STATE OF FLORIDA PROGRAMS

For a student to be eligible for State of Florida financial aid (i.e. FSAG) at OWCC –

- A student must have demonstrated a FINANCIAL NEED (Complete the FASFA application), and
- A student must have met the ADVERTISED DEADLINE, and
- A student must have been a RESIDENT OF FLORIDA for one-year, and
- A student must have a 2.0 or higher GRADE POINT AVERAGE on all previous college work, and
- A student must have earned 24 SEMESTER HOURS of college work during the terms of the academic year in which aid was received, and
- A student must have met CLAST requirements and
- A student must have signed the following STATEMENTS which are listed on the Student Aid Report and Student Award Letter:
  1. A statement of registration status
  2. A statement of educational purpose and certification statement on refunds and defaults

NOTE: An applicant who believes State financial aid has been wrongly denied has certain rights to appeal. The applicant may appeal if he believes the Department of Education has made an error in determining eligibility or in failing to transfer an award. Detailed information about filing an appeal is available from the OWCC Financial Aid Office.

## ADDITIONAL INFORMATION AND REQUIREMENTS

**Financial Aid Suspension.** Students who do not meet eligibility standards shall be suspended from federal financial aid until they have regained eligibility in accordance with the Academic Standards of Progress.

**Notification.** The Financial Aid Office will send a letter to all current financial aid recipients who are to be suspended. This letter goes to students not meeting standards of satisfactory progress or academic good standing. Suspended students will not receive financial aid for the following semester even if already enrolled. The notice will be ad-

ressed to the student's most current local address on file with the Office of the Registrar. IT SHALL BE THE RESPONSIBILITY OF THE STUDENT TO KEEP OWCC INFORMED OF A CORRECT MAILING ADDRESS AT ALL TIMES. The cost of enrollment during financial aid ineligibility must be borne by the student. Financial aid will not be available.

**Reinstatement and Appeals Process.** A student who loses eligibility has an opportunity to appeal through an appeal process. The appeal must be submitted to the Director of Financial Aid IN WRITING by the student. (Special appeals forms are available in the Financial Aid Office.) Members of the Student Financial Aid Committee will act as an appeals committee. The appellant is required to provide documentation as necessary for determination of financial aid eligibility and shall fulfill reasonable requests by the committee with reference to time of meeting, personal appearance, and supporting evidence. The committee will determine if mitigating circumstances exist. Mitigating circumstances are defined as:

1. Death of a close relative affecting the student's academic performance.
2. Illness of the student or close family member having direct effect upon the academic record.
3. Poor past record resulting from youthful carelessness, social or psychological immaturity.
4. Special circumstances of a specific and substantial nature of a unique kind as determined by the committee.

If mitigating circumstances are found to exist, the student may be restored to satisfactory academic standing for one semester after which the general standards will apply. Further restoration to satisfactory standing may occur only if progress during the intervening semester(s) clearly gives sound, documented evidence of progress. Progress must be acceptable to the appeals committee.

**Incompletes, Withdrawals.** A student who carries a recorded "Incomplete" at the time of evaluation will be given a one-semester grace period when meeting eligibility requirements and Standards of Progress. The student's record will be held in suspense, and a re-evaluation will be made at the end of the next semester for which the student is enrolled. If the "Incomplete" has not been changed to a letter grade at the time of re-evaluation and the Registrar's Office has not been notified of an extension, the student will be assigned a grade of "F." Such a grade may readily contribute to suspension of financial aid eligibility.

**Repeated Courses.** A student may use financial aid to repeat a course in which an "N", "D", or "F" has been earned. A student may not repeat a course for credit in which a grade of "C" or better was earned (unless permission of the Vice President for Instruction is obtained). The student may improve a grade in a course and the repeat credit (s) will be included in the total number of credits when determining enrollment status. The student must be making satisfactory progress.

**Remedial Courses.** Okaloosa-Walton Community College approves remedial courses for the use of financial aid and includes remedial courses where necessary when determining a student's enrollment status. Admission placement testing requirements will determine if remedial courses are needed in a student's degree program.

**Verification.** The U. S. Department of Education randomly flags a student's Student Aid Report (SAR) for verification. Students selected must provide all the necessary documents needed for this process (i.e. income tax forms, W-2 forms). Oka-

loosa-Walton Community College's Financial Aid Office retains the right to request supporting documents it deems necessary from any student to determine financial aid eligibility. For this reason, OWCC suggests that students do not file financial aid applications until the tax forms for the family are complete and correct. Inaccurate estimates of income and taxes paid may require extensive processing delays and verification of corrected data. All financial information reported **MUST BE CORRECT**. Penalties or delays may occur if the data is incorrect or incomplete .

## **VETERANS' BENEFITS**

The federal government has programs which provide some financial assistance for veterans and their dependents. These programs are described briefly on page 41. Assistance and information may be obtained from the campus Registrar's Office or from the Veterans Administration, Regional Office, P.O. Box 1437, St. Petersburg, Florida 33731.



*Of last year's graduating class, 67% received some sort of financial assistance. More than \$4,661,092 dollars was awarded to OW students in the form of grants, loans, scholarships, and other aid.*

**FINANCIAL AID ADMINISTERED BY OKALOOSA-WALTON COMMUNITY COLLEGE**

Name of Program	Funding Source	Qualifications		Min/Max Awards	Application Procedures	Application Priority Deadlines		Special Information
Federal Pell Grant	Federal	Available to students in a program of study, who are citizens or eligible non-citizens; must not have a baccalaureate degree; must follow standards of academic progress and incremental progress.		\$400-\$2300 (estimated per year)	1994-95 FASFA	Fall-4/1/94 Spring-10/1/94 Summer-2/1/95	Foundation Aid Program. Basic Component of most Student Financial Aid.	
Federal Supplemental Educational Opportunity Grant (SEOG)	Federal	Applicant must have a high need.		\$200-\$600 per year	1994-95 FASFA	4/1/94	Very limited; generally goes to those applicants with a very high need.	
Florida Student Assistance Grant	State	Applicant must be a full-time student who is a resident of Florida for at least one year and demonstrates a need.		\$200-\$700 per year	1994-95 FASFA	5/15/94	Early application is recommended since state funding may be limited.	
Federal Stafford Student Loan (formerly GSL)	Federal	Available to students in a program of study. Must be enrolled at least half-time.		\$2625 - Freshman \$3500 - Sophomore	1994-95 FASFA and Loan Application	At least 12 weeks before the end of the semester the student plans to attend.	Six month grace period after student stops attending school.	
Okaloosa-Walton Community College Short-Term Loan	OWCC	Available to students who maintain a minimum 2.0 grade point average (returning students) or incoming freshmen who have a need and an ability to repay the loan.		Partial tuition and books	OWCC Student Loan Contract	Normally completed during registration	Repayment is distributed in two equal payments during the semester on specified dates. A 3% processing fee is assessed. (See Financial Section of the Catalog for collection procedures.)	
Federal College Work Study Program (FWSP)	Federal	Applicant must be at least half-time with a financial need.		\$500-\$2000 per year	1994-95 FASFA OWCC Student Employment Contract	4/1/94	Jobs are on and off campus. Most positions are either 10, 15 or 20 hours per week. Pay is federal minimum wage.	
Florida Work Experience Program (FWEPE)	State	Program is designed for Education majors who demonstrate a financial need by completing the FASFA, enroll at least half-time and maintain a minimum of 2.0 GPA.		\$100-\$2000 per year	1994-95 FASFA OWCC Student Employment Contract	4/1/94	Students work in public schools within the College District.	
Student Assistants	OWCC	Student employment category available to all students at OWCC who have maintained a minimum 2.0 GPA.		\$100-\$2000 per year	1994-95 FASFA OWCC Student Employment Contract	Normally completed just prior to the start of each semester.	Positions are usually 10 hours per week on campus. Pay is federal minimum wage.	

**G R A N T S**

**L O A N S**

**W O R K**



# S C H O L A R S H I P S

Name of Program	Funding Source	Qualifications	Min/Max Awards	Application Procedures	Priority Deadlines	Special Information
Honors Scholarship	OWCC	Applicant must be class Valedictorian or Salutatorian from one of OWCC's nine area public high schools (scholarship passes to next ranked student in class).	Full Tuition & Fees for 64 semester hours	OWCC Scholarship Application	4/1/94	High School Principals and Senior Counselor's Recommendations. Two scholarships per each district high school.
Minority Honors Scholarship	OWCC	Applicant is top Black Student academically from each of OWCC's nine area public high schools (scholarship passes to next ranked student in class).	Full Tuition & Fees for 64 semester hours	OWCC Scholarship Application	4/1/94	High School Principals and Senior Counselor's Recommendations. One scholarship per each district high school.
Fine & Performing Arts Scholarship	OWCC	Auditions held each Spring by Fine & Performing Arts Division Director. Scholarships awarded in Show Choir, Orchestra, Theatre, Jazz Band, Visual Arts and Madrigals.	Full Tuition up to 16 semester hours	OWCC Scholarship Application	Open	High School Choir and/or Band Director's Recommendations. This scholarship can be renewed.
Athletic Scholarships	OWCC	Qualified applicants are recommended to contact OWCC'S Athletic Director for more information.	Full Tuition & Fees (may include room & board)	NJCAA Form and Letter of Intent	Deadlines Vary	Athletic Scholarships at OWCC include basketball, softball, and baseball.
Debate Team and Brain Bowl Team Scholarships	OWCC	Recipients are selected by OWCC faculty sponsors of the Debate Team and Brain Bowl Team.	Full Tuition and Fees	OWCC Scholarship Application	Open	Recipients participate on the OWCC Debate Team and Brain Bowl Team.
Leadership Award	OWCC	Each area high school receives a minimum of three and a maximum of eight per school depending on senior class size. 45 awarded annually in district.	\$200 Fall Semester Tuition Award	OWCC	4/1/94	High School Principals and Senior Counselor's Recommendations.
Directed Work Study Scholarship	OWCC	Recommendation of Department Chair/Division Director and approval of Vice President for Instruction.	No financial award. Fees paid by scholarship.	Directed Work Study Application	NLT Last day of semester registration.	One semester hour of credit per semester can be earned.
Student Government Association (SGA) President	OWCC	Student elected to the office of President of Student Government Association.	Full tuition for one year.	OWCC Scholarship Application	When Elected to Office	Contact Student Services for more information.
Regional Science and Engineering Fair/ OWCC Scholarship	OWCC	Awarded to thirteen Senior Grand Award winners and Senior Alternate selected yearly at area Science Fair.	Full tuition & fees for 64 semester hours	OWCC Scholarship application	Annual Science Fair	Must attend OWCC immediately upon high school graduation.
Designated & Undesignated Donor Scholarship	Local Community Org. & OWCC Foundation	Various selection criteria established by the donors.	Varies	Applications provided by donors and OWCC Foundation	Dates set by donors and OWCC Foundation	A large number of scholarships are available. Best source of applications is OWCC's Financial Aid Office, High School Guidance Office and local organizations.

# INSTRUCTIONAL PROGRAMS

## STANDARDS AND REGULATIONS

### FULL-TIME AND PART-TIME STATUS

Students are considered to be full-time or part-time according to the course load at the time of registration. A student enrolled for 12 or more semester hours, or 24 or more contact hours per week in noncredit courses, is considered to be a full-time student.

### AUDIT STATUS

Students registering in a college-credit course on a "not-for-credit" basis will be considered as audit students and their records will be marked accordingly. An "X" grade will be placed on the permanent record, and no hours attempted or quality points will be recorded. **Occupational courses may not be taken on an audit basis.**

Examinations for audit students are not required; however, audit students are expected to attend classes on the same basis as credit students and to meet all the requirements of the course with the exception of examinations. Excessive absences for audit students are treated the same as for credit students. The instructor may recommend to the Vice President for Instruction that the student be dropped from the class with a grade of "W."

Fees are the same for both credit and audit students.

Students may register for a class on an "Audit" basis at anytime during the regular registration period or change to "Audit" status prior to the date stated in the college calendar as the last day for dropping classes. "Audit" students must meet the same admission requirements as college-credit students.

Audit students may not change to credit status following the expiration of the Drop/Add period specified for each semester in the college calendar.

### CHANGE OF SCHEDULE

Changes in courses or sections may be made during the drop/add period specified in the college calendar and/or in the Schedule of Classes each semester. Any such changes shall be accomplished by completion and processing of required forms to the Registrar's Office on the Niceville campus and other OWCC locations.

### CLASS ATTENDANCE

Students are expected to attend all of their scheduled classes. The effect of absences upon grades is determined by the instructor who may recommend to the Vice President for Instruction a withdrawal grade whenever absences become excessive. Arranging to make up work missed because of legitimate class absence is the responsibility of the student in cooperation with the instructor(s). Instructors shall not, however, authorize major blocks of class absences (e.g., 25% or more of the total class hours) without approval of the Department Chair and the Vice President for Instruction.

**Attendance is recorded by the instructor who will report immediately to the Registrar's Office each student who has accumulated three consecutive day class absences or two (2) consecutive evening absences from class or three absences in a month. Further, each time a student has been tardy three times in a class, it will count as one absence. Each set of consecutive absences will be reported. Veterans are subject to the same attendance requirements as all other students (see page 41).**

### EXAMINATIONS AND GRADES

Final examinations are held at the end of each semester and must be taken at the scheduled time. If a student is absent from a final examination because of substantive illness or other approved reasons, a late examination will be given.

OWCC provides and maintains permanent records for all students registering for college courses, and grade reports are provided to all students within five days following the published date that grades are due in the Registrar's office each semester.

Letter grades will be assigned as follows: A-Excellent; B-Good; C-Average; D-Passing; F-Failing; I-Incomplete; V-Deferred Incomplete; S-Satisfactory; U-Unsatisfactory; N-No Grade (nonpunitive); and X-Audit.

Grade points per semester hour are as follows: A-4; B-3; C-2; D-1; and F-0. Grades of "I-Incomplete" will change to "F-Failing" at the end of the next 16-week semester following the issuance of the grade if work is not made up during that period of time. The "I" or "V" will carry "0" grade points until it is made up. "S's," "U's," "N's," and "X's" carry no grade points or credits. No grades or transcripts will be released to or for students with incomplete records or outstanding fees, loans, or fines.

## **INCOMPLETE GRADES**

A grade of "I" may be given when a student is unable to complete the required work because of clearly documented extenuating circumstances **and only** if the student has a reasonable chance of making a passing grade. The instructor files with the department chair and with the student concerned an outline of the work that must be completed with an estimate of the student's grade standing for work already completed during the semester. Work for the removal of the "I" must be completed prior to the END OF THE FINAL EXAM PERIOD in the next 16-week semester immediately following. The grade will revert to an "F" on the official transcript if not removed by that time. A grade of "I" shall not be given as a mid-term progress grade.

A deferred incomplete grade of "V" may be assigned by the teacher when approved absences preclude satisfactory course completion by the end of the next 16-week semester of enrollment.

## **NONPUNITIVE ("N") GRADES**

"N" grades may be awarded for modular-type courses only. For those courses in which college credits may be earned, the "N" will only be awarded at the end of the term in which a student could not complete the modular requirements necessary to earn a "standard" letter grade.

An "I" grade may be awarded if, by mutual agreement between student and instructor, the student understands and assumes the responsibility for completing all modules by the end of the next term (mandatory completion time for "I" grades). A grade of "V" may be awarded according to conditions stated above.

If a student has not completed a course in which the student received an "N" grade by the end of the second semester of enrollment in that course, the student will receive no more than a "C" for that course in any subsequent semester. Re-enrollment and payment of all necessary fees are required to be eligible in a following semester to earn a letter grade and the appropriate credits in a course in which an "N" has been awarded.

## **SATISFACTORY/UNSATISFACTORY ("S" AND "U") GRADES**

Noncredit courses in which in the issuance of the required grades other than S or U are to occur shall be approved in advance, individually, by the Vice President for Instruction based on appropriate written justification.

## **WITHDRAWALS**

1. A grade of "W" (with zero hours attempted) will be entered on the student's permanent record card for a properly executed withdrawal through the Registrar's Office. Withdrawals must take place before the end of the week following the due date for mid-term grades in the fall and spring semester, and the end of the fourth week for Summer Terms I and II but after the drop/add period indicated in the college calendar. Withdrawals are also authorized for eight-week and other short classes up to the third college workday beyond the class mid-point.
2. WITHDRAWALS may be permitted after the end of the tenth week for the fall and spring semesters, the seventh week for the summer semester, and the fourth week for Term I and II based on extenuating, justifiable reasons. If the student feels a grade of "W" is appropriate, the student will be responsible for validation of the specific extenuating circumstances and for filing a written request with the Registrar for referral to the Vice President for Instruction for appropriate action.

**A student withdrawing from the college or dropping any course must file an official drop/add slip in the Office of the Registrar and the Comptroller's Office to avoid receiving an automatic grade of "F" in the course(s) concerned. (See paragraphs 1 and 2, above, for withdrawal without "F" grades).**

## **ACADEMIC STANDING**

Each college program has appropriate standards ranging from recognition of excellence to discontinuance for inadequate progress toward the respective program goals. These standards apply to full-time and part-time college-credit students. (Alternative noncredit programming and adult education opportunities are available for persons who do not choose to continue in degree or credit certificate programs.) For those who enroll as part-time college-credit students (less than twelve (12) cumulative semester hours) the cumulative grade-point average will not be computed for honors or sub-standard academic performance until the student has attempted a minimum of twelve (12) cumulative semester hours. It will be computed each twelve (12) hours thereafter.

**Superior Scholastic Performance.** When the quality of a student's work is superior, the college is pleased to honor such work through recognition as follows:

**PRESIDENT'S LIST.** Full-time students (or part-time students for each cumulative twelve hours) who make a grade-point average of 3.80-4.00 in college level courses during any semester are placed on the President's list.

**DEAN'S LIST.** Full-time students (or part-time students for each cumulative twelve hours) who make a grade-point average of 3.50-3.79 in college level courses during any semester are placed on the Dean's list.

**HONORS AND HIGH HONORS.** At the time of graduation, a student's total academic record is reviewed to determine High Honors (3.80-4.00) and Honors (3.50-3.79). For students to graduate with this distinction, they must have earned 24 or more hours of credit at OWCC and must have attained these same standards on all work done at OWCC as well as any cumulative academic work from prior institutions of higher education.

**Good Standing.** A student is considered in good academic standing as long as the student maintains the appropriate cumulative grade-point average (GPA) specified in the following schedule for satisfactory academic progress and while on academic probation. Students on academic suspension are not considered to be in good standing:

Credit Hours Attempted	Minimum Required GPA
12	1.50
24	1.70
36	1.80
48	1.90
60 or over	2.00

**Substandard Academic Performance.** When the quality of a student's work is substandard, the college is obligated to initiate restrictions relative to further studies and to apprise that student of the serious nature of his/her academic status. For these reasons, the following regulations pertain with respect to academic probation and suspension.

**Academic Probation.** Any student who fails to maintain the appropriate grade-point average specified in the schedule listed above under "Good Standing" shall be placed on Academic Probation. This requirement is based on the fact that a student, to graduate from this college, must attain a cumulative grade-point average of not less than 2.0 ("C") on all college-level work attempted - including all work at Okaloosa-Walton Community College plus work which is transferred from any previously attended institutions of higher education. All work at previous institutions of higher education will be counted, not just selected courses. The college will notify students of any shortages of grade points

with respect to these standards. The record of any student who fails to meet these standards shall be stamped "Academic Probation."

**IT IS STRONGLY RECOMMENDED THAT A STUDENT ON ACADEMIC PROBATION CONTACT A FACULTY ADVISOR OR A COUNSELOR WITH REGARD TO ENROLLING IN DEVELOPMENTAL, COLLEGE PREPARATORY, COMPENSATORY, OR SPECIFIED NONCREDIT COURSES TO CORRECT AREAS OF DEFICIENCY.**

To be removed from academic probation, a student must increase the cumulative grade-point average for all work attempted to at least the level specified in the Schedule of Satisfactory Academic Progress.

**Academic Suspension.** A student who has been on academic probation two consecutive semesters shall be considered to be making unsatisfactory progress and will be suspended for a minimum of one semester. For the student whose record necessitates academic suspension, the entry "Academic Suspension for a Minimum of One Semester" shall be stamped on the permanent record.

Any full-time student (or part-time student who has accumulated 12 credits) who fails all courses in academic work shall be suspended for a minimum of one semester.

**IT IS STRONGLY RECOMMENDED THAT A STUDENT PETITION FOR ENROLLMENT IN CERTAIN AUTHORIZED DEVELOPMENTAL, COLLEGE PREPARATORY, VOCATIONAL PREPARATORY, OR SPECIFIED NON-CREDIT COURSES DURING THE SEMESTER OF SUSPENSION TO STRENGTHEN THE AREAS OF DEFICIENCY. ALSO, SUCH STUDENTS SHOULD SEEK COUNSELING ASSISTANCE REGARDING THE APPROPRIATENESS OF THEIR OBJECTIVES.**

**Readmission.** To be readmitted to Okaloosa-Walton Community College following academic suspension, a standard readmission form needs to be submitted to the Director of Admissions. (The form is available in the Admissions and Registration Office on the Niceville campus, at the OWCC Eglin and Hurlburt Centers, at the OWCC/UWF Fort Walton Beach Campus, the OWCC Chautauqua Center in DeFuniak Springs and the OWCC Robert L. F. Sikes Education Center in Crestview.) Approval of such requests is most frequently granted after one semester out of college unless the prognosis for academic success is especially poor or there are conditions other than academic status involved. Students re-entering after suspension will be placed on academic probation and will be subject to the rules pertaining to substandard academic performance.

### **Academic History Forgiveness Policy.**

Should a student whose credits are ten or more years old desire to seek relief from the effect of those grades upon his/her current record at OWCC, a written request for such relief may be made to the Vice President for Instruction through the Office of the Registrar. Should favorable action be taken, the courses and grades will continue on the face of the permanent record, but relief will be in not counting such grades and hours in grade-point computations. The action of the college upon such a petition shall be final. No credit passed or failed that is ten (10) or more years old will be counted if such relief is granted. Such courses may be a sound basis for seeking contemporary credit through comprehensive examinations.

**Repeated Courses.\*** For any course repeated, whether at OWCC or elsewhere, only credit from the last attempt will be used in the computation of the final grade-point average (GPA) and for meeting degree requirements. Students should be aware that repeating a course results in an adjusted grade-point average\*\* and that such an adjustment may not be accepted by some private colleges and universities.

**Foreign Language Requirements for Entry into Upper Level Florida Universities.** Effective August 1, 1990, according to requirements of the Florida Board of Regents, new applicants to any of the state universities must have completed two years of one foreign language in high school. Eight to ten semester credits in one foreign language at the postsecondary level will also meet the minimum entry requirement. **EXEMPTIONS:** (1) Students who receive an AA Degree prior to September 1, 1989 or (2) who enroll in a program leading to an AA degree prior to August 1, 1989 and maintain continuous enrollment are exempt from the admissions requirement and will not have to take 8-10 credits prior to graduation from the SUS. **EXCEPTIONS:** Students who are not exempt may be admitted to the university as part of the 5% exception group but must complete 8-10 hours foreign language before graduation regardless of major's graduation requirements.

Students transferring to the SUS with less than 60 transferable hours and who have not met the foreign language admissions requirement must complete 8-10 of these before going on to the upper division.

\* NOTE: Students on VA benefits should be aware that the Veterans Administration WILL NOT PAY for a repeated course in which a grade of "D" or better has been earned, except where state rules require a minimum grade of "C".

\*\* NOTE: GPA's are NOT changed for courses repeated after a student receives an AA Degree (Per Articulation Agreement).

Okaloosa-Walton Community College offers the necessary instruction in French and Spanish to meet the provisions of the SUS admission requirements. Students are encouraged to enroll for the courses which they will need to be fully admitted when ready to transfer.

## **DIRECTED INDEPENDENT STUDY**

Directed independent study provides opportunities for students to earn college credits in standard courses by working with an OWCC instructor on an independent basis. Students enrolling for courses under Directed Independent Study (DIS) are expected to accomplish the goals and objectives as specified in the course syllabus and are expected to attend such class meetings, group sessions, and working conferences as specified by the instructor. Courses are scheduled on a flexible basis as approved by the instructor, the department chair, and by the Vice President for Instruction with the understanding that final exams will be taken and grades awarded during the term in which they begin.

DIS course enrollments are authorized under the following conditions: (1) a documented need exists for the student(s) to enroll for the course immediately rather than taking an alternate course or waiting until the next semester in which the desired course would be offered; (2) the student is able to identify an instructor who is willing to teach the course as DIS; (3) the student understands the extensive burden which he or she is undertaking; (4) the student agrees to pay the DIS special fee; (5) enrollment is approved by the Department Chair and Vice President for Instruction, and (6) when it is not feasible for the course/section to be scheduled concurrently and taught at the same time and locations as another course/section.

*DIS course fees.* All regular fees apply to DIS courses in addition to a special fee of \$25 per credit hour which would be assessed for each registration in specially designated sections.

## **COMMUNICATIONS DEPARTMENT WRITING SAMPLE**

### **MANDATORY WRITING SAMPLE**

The writing sample is required of all students who wish to register for ENC 1101 English Composition I. The student will write the paragraph at the time of the placement testing. The writing sample will also be administered at each registration location for students who have previously completed the placement test. A team of instructors from the Communications Department will be available to evaluate the content and grammar of the sample paragraph. If the student scores above the recommended cutoff on the placement test, the recommendation on the writing sample will be mandatory for student placement in ENC 1101 Composition I,

or LIN 1340 Writing and Grammar, and recommended for placement in ENC 0010 or ENC 0020 College Prep English. However, if the student scores below the recommended cutoff on the placement test, the student must enroll in the appropriate level of College Prep English (ENC 0010 or ENC 0020) based on the writing sample recommendation.

## COLLEGE LEVEL ACADEMIC SKILLS TEST

Florida has developed a test of college-level communication and computation skills entitled **College Level Academic Skills Test (CLAST)**. The CLAST tests communication and computation skills judged by state university and community college faculty to be associated with successful performance in higher education. The test is administered to all students seeking an Associate of Arts degree. It is required by Florida Statutes and by Administrative Rules of the State Board of Education. A student may register for CLAST upon completion of 18 credit hours under the conditions listed below:

### **First Time Test Takers**

**Communications.** Students will be eligible to register for the Essay, Reading, and English Language Skills subtests when they have successfully completed or are currently enrolled in ENC 1102 Composition II.

**Mathematics.** Students will be eligible to register for the Mathematics subtest when they have successfully completed six hours of Gordon Rule math courses or when they are enrolled in their second Gordon Rule course.

AA Students on State Financial Aid who have not met the above requirements and are nearing their 60th semester hour should contact the Institutional Test Administrator, Dr. Sue Bridges, for an exception to the above requirements.

### **Retester**

**Communications and Mathematics.** Students who fail any CLAST subtest will be required to complete supervised preparation before retesting. The actual requirements will be determined on an individual basis by representatives from the math and communications departments. Individual prescriptions for preparation will be written for each student who wishes to prepare for retesting.

The CLAST is administered each semester to community college students who are completing Associate of Arts degree programs or who are otherwise seeking admission to upper division programs in state universities in Florida. **Only students who pass all four (4) subtests of the CLAST can be legally awarded the Associate of Arts degree.** Only students who have passed all four (4) CLAST subtests can be unconditionally admitted to the upper divisions of the State University System.

Without the CLAST, admission to state universities in Florida will be on a conditional basis. The student may take only a limited number of courses until all four subtests of the CLAST are passed. (Currently, students passing three out of four subtests may enroll for up to 36 semester hours of coursework beyond the sophomore level. They must pass the fourth subtest before being allowed to continue). The CLAST also applies to students transferring to Florida universities from private institutions in Florida and from out-of-state colleges and universities.

As required by statutes, the State Board of Education has established minimum CLAST score standards for award of the Associate of Arts degree and for admission to upper division status in state universities in Florida.

Date	Reading	Writing	Computation	Essay
August 1, 1986 - July 31, 1989	270	270	275	4
August 1, 1989 - Sept. 30, 1991	295	295	285	4
Oct. 1, 1991 - Sept. 30, 1992	295	295	290	5
Oct. 1, 1992	295	295	295	6

A student must present scores that meet minimum standards in effect at the time he or she **initially takes the test** to meet minimum state board standards for the Associate of Arts degree or to attain upper division status in a state university.

**Waiver.** Students who have taken any of the four (4) subtests of the College-Level Academic Skills Test at least four (4) times and have not earned a passing score on the subtest but has otherwise earned a minimum grade point average of 2.0 in all college credit courses in that same subject area and met the requirements defined in Rule 6A 10.030, FAC., for that area may appeal to the CLAST Waiver Committee for a waiver from that subtest.

In considering a request for a waiver from any subtest, the CLAST Waiver Committee shall determine whether the student has demonstrated sufficient effort to pass the subtest and has satisfactorily completed remediation studies related to the failed subtest.

The Dean of Student Services (telephone 729-5371) provides information on how and when to apply to take the CLAST. The Vice President for Instruction can provide a list of CLAST skills and identify where the communication and computation skills are taught in the curriculum.

**THE CLAST TEST WILL BE GIVEN ON OCTOBER 1, 1994, FEBRUARY 18, 1995, AND JUNE 3, 1995. NOTICES REGARDING CLAST APPLICATION DEADLINES ARE PUBLISHED IN THE COLLEGE CALENDAR AND IN THE OWCC CONNECTION.**

## **REQUIREMENTS FOR GRADUATION**

General requirements for graduation from Okaloosa-Walton Community College must be met by all students seeking a degree without regard to the degree to be granted. **Final responsibility for meeting the requirements for graduation rests with the student.** If the student is in doubt about course requirements, the academic advisor should be contacted before each registration. Students should check with their faculty advisor or an OWCC counselor during their next to last semester to ensure all graduation requirements will be met by the end of the next semester. Participation in graduation exercises is expected.

1. Students must have a total of 64 semester hours for graduation, including a minimum of 42 semester hours of General Education courses for the Associate of Arts degree; 26 semester hours of General Education courses for the Associate of Science degree; (16 semester hours of General Education courses for the Applied Science Options). The remaining hours in each program may be taken in any one of the prescribed programs or in a planned program approved in writing by the Vice President for Instruction.
2. Students must make formal application for graduation, and if seeking an AA degree (or planning transfer with an AS degree) apply for the College Level Academic Skills Test on the proper forms furnished by the Registrar. Students must meet the deadlines designated in the college calendar which appears in the college catalog. To receive an AA degree a student must pass all four (4) subtests of the CLAST.
3. Each graduate must be in attendance during the semester in which the degree is earned and must have earned no less than 15 semesters credit hours from OWCC. Students leaving OWCC who later apply for a degree must have met the degree requirements at the time of their last OWCC enrollment; they must also have earned 15 semester hours at OWCC. Exceptions may be granted only by special written request submitted to the Registrar and approved by the Vice President for Instruction, e.g., Servicemember's Opportunity College agreements.
4. Students who maintain continuous enrollment after entering OWCC have the option of graduating under either the catalog in place at the time they first enter OWCC or the catalog in place at the time graduation requirements are completed. If attendance is interrupted for two consecutive semesters **excluding** summer sessions, they must graduate under the catalog in place when readmitted or the one in place when degree requirements are completed.
5. A grade-point average of not less than 2.0 ("C") must be attained on the cumulative total

of all work attempted whether at OWCC or by transfer. The minimum grade-point average for all course work attempted at OWCC must be 2.0 ("C").

6. Qualification for graduation with Honors or High Honors will be computed on the total of all degree work attempted whether at OWCC or by transfer. A student shall graduate with Honors or High Honors only if the degree work done at OWCC qualifies.
7. Four (4) semester hours of activity Physical Education credit are required for graduation. All regularly enrolled students seeking an AA or AS degree should enroll in at least one PE course each semester until the four semester hour requirement is met.

**STUDENTS EXEMPT FROM PHYSICAL EDUCATION COURSES MUST MAKE UP THE FOUR SEMESTER CREDIT HOURS BY TAKING NONACTIVITY PHYSICAL EDUCATION COURSES.**

Exemptions are as follows:

- a. **Physical Disability:** A student with a restrictive physical disability must provide a written statement from a physician to the Physical Education Department Chair for approval. If approval is recommended, the medical statement and waiver are submitted to the Vice President for Instruction for final approval. These students must take four semester hours of nonactivity Physical Education courses.
- b. **Age:** Students who have reached their 30th birthday are not required to enroll in Physical Education activity courses but must take four semester hours of nonactivity Physical Education courses.
- c. **Evidence of Extreme Hardship:** Students completing requirements by attending evening classes only and/or part-time day students having difficulty in scheduling and/or meeting the requirements should work **directly with the Physical Education chair** for a solution to the problem, preferably during their first semester of enrollment.

Nonactivity courses which meet graduation requirements for persons exempt from Physical Education activity courses are as follows:

- HSC 1400 – First Aid
- PEM 1105 – Fitness Concepts
- HSC 1000 – Health Concepts
- HSC 1100 – Health Education
- PEO 1218 – Softball/Baseball Officiating
- PEO 1623 – Basketball Officiating
- PEO 2513 – Soccer Officiating
- PET 1020 – Introduction to Physical Ed.
- PET 2622 – Athletic Injuries

## **CREDIT BY ALTERNATIVE MEANS**

Students may earn a maximum of 45 college credits through a combination of nontraditional sources as listed below:

**Advanced Placement Credits:** Okaloosa-Walton Community College participates in the **Advanced Placement Program** conducted by the College Entrance Examination Board, which provides 13 college-level, advanced placement examinations. Okaloosa-Walton Community College allows a maximum of 15 semester hours credit for scores of three, four, and five, and allows advanced placement **without credit** for scores of two upon recommendation of the department concerned.

Advanced Placement Tests may be taken at participating high schools or centers. A qualified student may make a request and pay the required fees to the College Entrance Examination Board, Educational Testing Service, Princeton, New Jersey, to make arrangements to have the test or tests sent to and administered by the Coordinator of Testing at OWCC. Information bulletins are available from the Education Testing Service upon request.

**Credit is not awarded for a score of 1 or 2 on the English subtest of the Advanced Placement Test. A score of 3 or 4 allows the student credit for ENC 1102 without writing an additional 6,000 words. A score of 5 gives the student credit for both ENC 1101 and ENC 1102 without writing an additional 12,000 words.**

**CLEP General Examination:** Students may earn up to 30 semester hours of credit by passing the College-Level General Examinations at the national 50th percentile or better based upon the combined Male/Female Sophomore Norms. Students may not attempt credit by examination if they have earned six or more semester credits with a grade of "C" or better in courses whose content includes materials similar to the materials to be covered in the test. This rule also applied to courses taken at the upper level in a senior university as well as the junior college level courses. If a student has earned fewer than six semester credits in such courses, they will be awarded the difference between the numbers of semester hours earned and the six semester hours. Students must take the 90-minute examinations. In addition, the English portion requires the written essay be taken for credit to be awarded.

**CLEP credits for mathematics and English:** CLEP credits awarded fall semester 1982 or later and based on general and subject examinations in

English and humanities will be accepted as elective credit. This elective credit can be used toward fulfillment of the English and humanities requirements at OWCC when the student satisfies the 6,000 word writing requirement mandated for English and humanities courses by State Board Rule 6A-10.030. The student can satisfy this rule by enrolling in ENG 1001 Research Papers, one semester hour (one enrollment for each three semester hours awarded in English and/or HUM 1905 for humanities); a grade of "C" or higher must be earned in each enrollment in the Research Papers or Independent Study Humanities courses to satisfy the general education writing requirement. These courses may be repeated as needed to fulfill the total writing requirement.

In mathematics, students will be able to receive credit for Finite Math through the general examination. For college algebra or higher, credits are awarded on the basis of the subject examination only.

**CLEP Subject Examinations:** Students may earn college credits in the Subject Examinations listed as follows provided they have not completed a college level degree-credit course with a "C" or better which is higher than or equivalent to the subject matter examination they plan to take.

American Government, American History I, American History II, American Literature, Analysis & Interpretation of Literature, Calculus w/Elementary Functions, College Algebra, College Algebra/Trigonometry, \*College Composition w/Essay, College French, College German, College Spanish, English Literature, \*Freshman English w/Essay, \*General Biology, General Chemistry, Human Growth & Development, Information Systems & Computer Applications, Introduction to Educational Psychology, Introduction to Management, Introductory Accounting, Introductory Business Law, Introductory Macroeconomics, Introductory Microeconomics, Introductory Psychology, Introductory Sociology, Principles of Marketing, Trigonometry, Western Civilization I, Western Civilization II.

Students attempting to earn credit by examination should contact the Registrar first to determine their eligibility for credit in accordance with FAC Rule 6A-10.024. All credit awarded will be posted on the student record.

Some institutions do not award credit for CLEP Examinations. It is the student's responsibility to contact any institution to which the student expects to transfer to determine if that institution will accept CLEP transfer credits.

**Comprehensive Examination for Credit in Designated Courses:** Students who are admitted to the college may be granted credit in designated

\* Students may not receive credits for Biology or English Composition on the Subject Examination and also receive credit in the same areas in the General Examination.



courses based on knowledge or ability as measured by an examination in the area in which credit is being sought. Designated courses that may be completed through a Comprehensive Examination are on file in the Vice President for Instruction's office.

To be eligible for credit by Comprehensive Course Examination the student must:

1. Be admitted to OWCC.
2. Complete necessary application form for Comprehensive Course Examination, securing the signature of the appropriate department chair (setting date for examination) and the Vice President for Instruction.
3. After Item 2, present form to Comptroller's office and pay the Comprehensive Examination Testing Fee (100 percent of registration/ tuition fee for course, excluding lab fee), returning form after payment of fee to the Vice President for Instruction. The Comprehensive Examination Testing Fee may be paid anytime after the end of late registration, or as approved by the Vice President for Instruction upon written request from the student and department chair.
4. Complete the examination on date as scheduled. Examination date must precede final exams for the term in which it is scheduled.
5. Credits will be awarded for passing grades earned on comprehensive examinations. (See footnotes on the AA degree General Education page for certain minimum grade restrictions.)

Comprehensive Course Examinations will be administered by the Department Chair. A Comprehensive Course Examination in a particular course may not be taken more than one time for a designated course.

Credit awarded by Comprehensive Course Examination will become part of a student's permanent record and will be posted to the student's transcript with the appropriate grade if all fees are paid within deadlines stated.

No more than 45 semester hours of nontraditional credit may be earned through this means or any combination of sources (i.e., CLEP, military experience, etc.).

**Correspondence Course Credits:** Up to nine semester hours of credit for correspondence and/or extension courses may be transferred from a college or university accredited by the appropriate regional accrediting association. These hours may include, but not be in addition to, the credits available through the Servicemember's Opportunity College Program.

**Competency Testing:** The AS degree at OWCC requires 38 semester hours in a specialization. The 30 semester hours that may be received

through testing may not apply toward the last 8 hours for the AS or the last 18 hours for the Applied Science Options normally taken by students enrolling for all courses in their program at OWCC. Students requesting credit through competency testing will prepare a program planning form in cooperation with the appropriate department chair or program advisor to select the general education courses and the final occupational credits required for the degree (64 semester hours, total).

**1. Departmental Competency Testing:** Students who have completed a diploma or certificate from an accredited vocational or technical school at less than the college level may receive up to 12 semester hours of credit in a related vocational program at OWCC. Credit is awarded based on the student's performance on departmental competency tests and the recommendation of the department chair to the Vice President for Instruction. There is no charge for the competency tests.

**2. Credit for Earned Vocational Certificates.** Students who complete a vocational school certificate program which is contained in an approved agreement with the college will receive up to a maximum of 36 semester credits applicable toward an AS Applied Science Option degree. Such programs must be included in a formal written activities agreement between the college and the vocational school. OWCC currently has an agreement with the School Board of Okaloosa County/ Bay Area Vocational School to award credit as follows:

**OWCC AS/AAS Programs**

AC/Heating/Refrigeration	36
Automotive Mechanics	36
Commercial Food Service	24
Electronics Technology	15
Welding Technology	36
Child Development & Education Services	12

**Bay Area**

<b>Certificate Program</b>	<b>Max Credit</b>
AC/Heating/Refrigeration	36
Automotive Mechanics	36
Food Production	24
Industrial Electronics	15
Welding	15

**3. Occupational Competency Testing:** Students with extensive on-the-job work experience and/or other noncertified training may receive 30 semester hours credit at OWCC upon successful completion of occupational competency examinations as administered by the Occupational Testing Center at the University of South Florida, Tampa. Such credits

will be awarded in all curricula where OWCC offers AS degrees, contingent upon the person completing the remaining credits at OKALOOSA-WALTON COMMUNITY COLLEGE which are required for program completion.

#### **Who may apply:**

Persons who are currently employed as industrial-technical instructors, students who are pursuing fulfillment of their first 64 semester hours of college level studies leading toward an industrial-technical teacher education degree in the state university system, and persons who desire state certification as an instructor in industrial-technical education.

#### **How to apply:**

Applications should be submitted directly to the Occupational Testing Center, University of South Florida, FAO 226, Tampa, FL 33620. Forms, test dates, location, fees and other information should be requested from USF at the above address or call long distance (813/974-2100.)

#### **How to receive credit:**

Request the USF Testing Center to send a report of the competency exams directly to the Registrar at OWCC if not already enrolled; request an advisor to complete the program planning form which will specify the advanced courses required for completing the AS degree; enroll for and complete the specified courses with a "C" or higher grade average (minimum 2.0 GPA); and apply for graduation. NOTE: Competency credits will not be fulfilled until the application for graduation has been submitted and approved.

### **SERVICEMEMBER'S OPPORTUNITY COLLEGE**

Okaloosa-Walton Community College subscribes to the principles of the Servicemember's Opportunity College and has established flexible policies including credits and/or course waivers based on CLEP, DANTES/USAFI, CASE Guide, and "challenge" examinations geared to the needs of active-duty service persons (maximum 45 credit hours). Active-duty personnel stationed at Eglin Air Force Base and Hurlburt Field who have earned a minimum of 15 approved degree credits from OWCC may transfer other approved credits back to OWCC from any accredited college or university to be applied toward the associate degree. Interested personnel should consult with Okaloosa-Walton Community College's educational advisor in the college's on-base office or with their Education Services Officer for complete details regarding the SOC.

**Transfer Credits:** Course work with a grade of "C" or above from a college or university accredited by the appropriate regional accrediting association will be accepted. A grade of "D" from properly accredited institutions of higher education will be accepted on a provisional basis, except for selected courses where OWCC students are required to earn a grade of "C" or above. The student must bring the GPA up to a 2.0 while at OWCC. The acceptability of college courses for transfer credit at OWCC shall be at the discretion of the Registrar in conjunction with the chair of the department involved.

### **CREDITS FOR ARMED SERVICES SCHOOLS AND MILITARY TRAINING**

Credits resulting from classroom-type instruction (i.e., excluding on-the-job training and correspondence-type courses) at U.S. Air Force Schools will be evaluated as stated on the official transcripts issued by the Community College of the Air Force. Credits for occupational and vocational-technical courses will apply only toward an AS degree or Occupational Certificate. Credits for classroom instruction from military schools other than the established academies of the U.S. Air Force, U.S. Army, U.S. Coast Guard, U.S. Marine Corps, and U.S. Navy will be evaluated by the OWCC Registrar according to the ACE Guide. DANTES/USAFI credits will be evaluated by the OWCC Registrar in keeping with the state of Florida Articulation Agreement between community colleges and universities.

### **TRANSFERRING TO A SENIOR INSTITUTION**

Those students who expect to transfer to a senior institution may obtain programming assistance by consulting a faculty advisor or counselor. Faculty advisors and counselors will gladly assist in planning and coordinating college programs to facilitate smooth transfers to senior institutions. Liaison representatives from the respective public senior universities in Florida are eager to assist OWCC students. Their names are available from the Office of the Dean of Student Services or college counselors.

It is desirable that students transferring to a senior institution plan their program so that the transfer may occur at the beginning of the school year (normally in the fall). Curricula are generally offered in sequence. It is best for the student to complete the entire two-year program before transferring. Students majoring in highly specialized programs should seek programming assistance well in advance of actual transfer.

STUDENTS PLANNING ON RECEIVING AN AA DEGREE OR ON TRANSFERRING TO THE UPPER DIVISION OF A STATE UNIVERSITY IN FLORIDA MUST HAVE TAKEN AND PASSED THE COLLEGE-LEVEL ACADEMIC SKILLS TEST (CLAST).

## **VETERANS' EDUCATIONAL BENEFITS**

The college is certified for training by the State Approving Agency under the various veterans' training laws. Veterans planning to enroll at OWCC should consult with the Veterans Affairs Office well in advance of registering. The veteran must complete a special form (available in the Veterans Affairs Office) which is required by the Veterans Administration for initial certification and, there upon, assume responsibility for all fees from his/her own resources or out of monies paid to the individual by the Veterans Administration.

Veterans are normally expected to pay all fees at registration. Because the "advanced payment" first check is sometimes delayed, it is advisable that the veteran be prepared to meet all expenses until that check is received. Veterans attending the college under Public Law 894 (disabled veterans) who have approval from the Veterans Administration will have registration fees paid directly to the college by the federal government.

For VA purposes, training time is usually computed as follows:

12 or more semester hours .....	Full-time
9-11 semester hours .....	3/4-time
6-8 semester hours .....	1/2-time

For the summer semester and Terms I and II, training time is computed differently: The VA determines credits for summer course work each year and notifies the college accordingly. Veterans are advised to contact the Veterans Affairs Office before registering for summer semester and summer term classes to determine training status.

Any student-veteran who is absent three consecutive class sessions or school days without pre-notifying the Veterans Affairs office (and confirming that notice in writing) will be interrupted from training for pay purposes, and the Veterans Administration will be notified. The veteran who has been interrupted from training for pay purposes will have to request enrollment recertification through the Veterans Affairs office to request the VA payments be resumed.

A veteran who wishes to receive VA benefits should notify the OWCC Veterans Affairs Office prior to registration to expedite the request for subsistence allowance. Veterans, widows of veterans, and war orphans desiring information about benefits, requirements, and registration procedures should contact the Veterans Affairs Office.

## **VETERANS' FEE DEFERMENT POLICY**

Any eligible veteran or other person who wishes to pursue an approved program of education or training at Okaloosa-Walton Community College (within the meaning of Chapter 32, 34, or 35, Title

38, United States Code) and who meets the conditions stated in 240.345(2)(b)1 shall, in the first term of enrollment in any fiscal year, be granted upon request a sixty (60) day deferment for full payment of fees from the last date to pay fees, provided the period of deferment shall not extend beyond 10 days before the end of the term.

Deferment of fee payment for eligible persons after the first enrollment period in any fiscal year is not authorized. An eligible person who can document a substantial, unique financial hardship may petition the Financial Aid Office to seek special consideration for a 60-day deferment. This must have the approval of the Director of Financial Aid, the Veteran's Affairs Counselor, and the Comptroller before being committed or granted.

Under no circumstances shall any person be allowed to enroll or re-enroll at OWCC who has failed to pay any prior fee deferment.

## **ACADEMIC ADVISING**

Faculty advisors are assigned to students to assist them with the proper courses to fulfill their program objectives. Anyone desiring to establish or to change advisors should contact the Registrar's Office in the Student Services building on the Niceville campus or any of the off-campus center directors. Students may find out who their advisors are and how to contact them by checking the following locations where advisor listings are maintained.

Registrar's Office (Student Services Building)  
OWCC Eglin Center, Bldg. 251  
Library Circulation Desk (Learning Resources Center)  
OWCC Ft. Walton Beach Campus  
Martin Luther King, Jr. Boulevard  
Evening Office (College Mall)  
Counseling Office (Student Services Building)  
OWCC Chautauqua Center, DeFuniak Springs  
Vice President for Instruction (Administration Building)  
OWCC Robert L.F. Sikes Education Center, Crestview

Faculty advisors are assigned based upon the student's declared program objective. These advisors, other faculty members, or any counselor have advising materials and will assist students prepare a program plan which may be used as a guide in the selection of courses each semester. Students who have not selected a program objective are assigned among the various departments.

## SPECIAL COMMENTS CONCERNING ENGLISH AND READING

1. Students who score below acceptable minimums on Writing and Reading placement tests must take the appropriate college preparatory course — ENC 0010 or ENC 0020 and/or REA 0001 .
2. Students scoring below the cutoff level in one or more categories of a state required placement test are required to enroll in at least one college prep course each semester until all deficiencies are removed with a minimum grade of "C." Only three attempts are allowed in each college prep course according to State Department of Education rules. Withdrawals prior to the mid-point of a college prep course do not count as one of the three attempts (per state board rules).
3. Students who score at or above the minimum cutoff levels **may** take the college prep course; however, it is recommended that students scoring above the cutoff in writing but

who still need assistance with the basics, may either elect or be required (on the basis of the writing sample evaluation) to take LIN1670 Writing/Grammar, a 3-credit course which reviews basic rules of grammar with emphasis on paragraph development. This course may be used as a general education elective for the AA Degree and to meet part of the English requirements for the AS and AS/AAS Option Degrees.

4. REA 2105 Advanced Reading, is recommended for students scoring above the placement cutoff level but who need to increase their reading speed and level of comprehension.
5. Students scoring below the cutoff level in reading are advised to limit the number of courses they schedule each term that require extensive reading until completing REA 0001 College Prep Reading.

The following diagram indicates certain required and recommended tracks to satisfy requirements for English communications and reading:

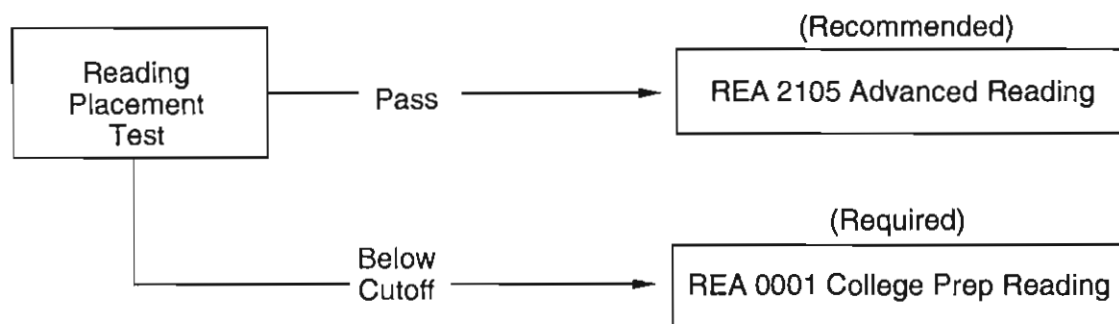
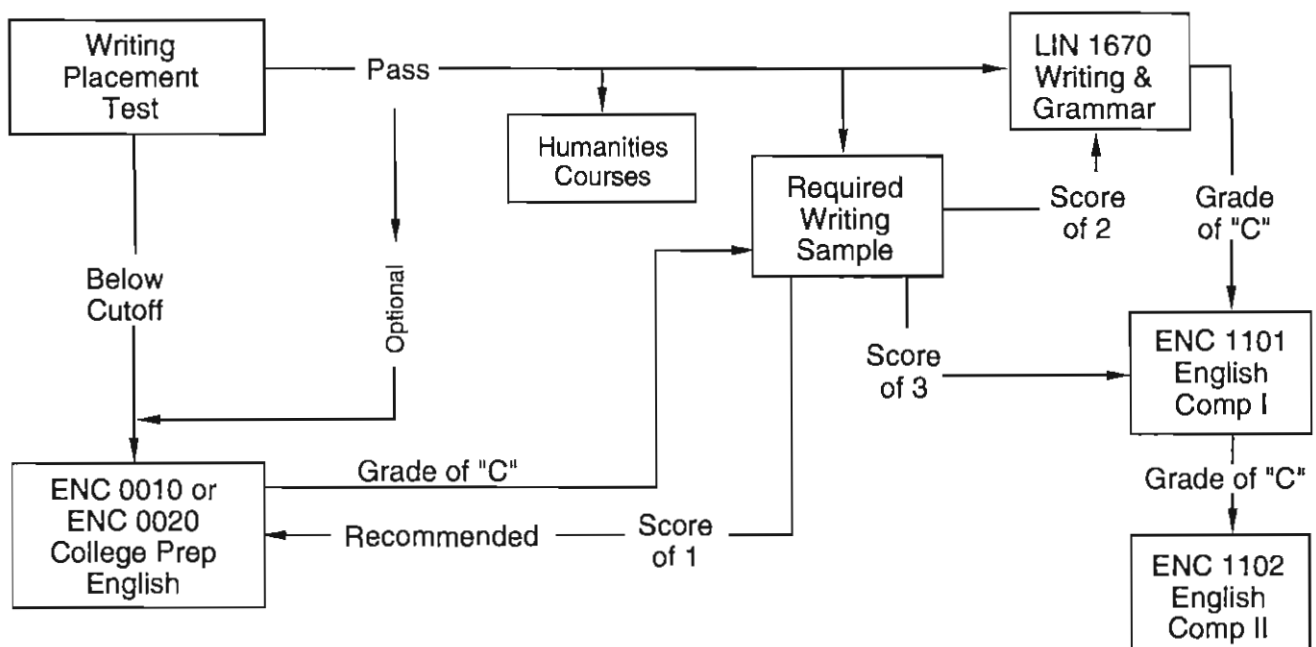

## SPECIAL COMMENTS CONCERNING MATHEMATICS

The following diagram indicates possible tracks to satisfy mathematic requirements depending upon background and program needs:

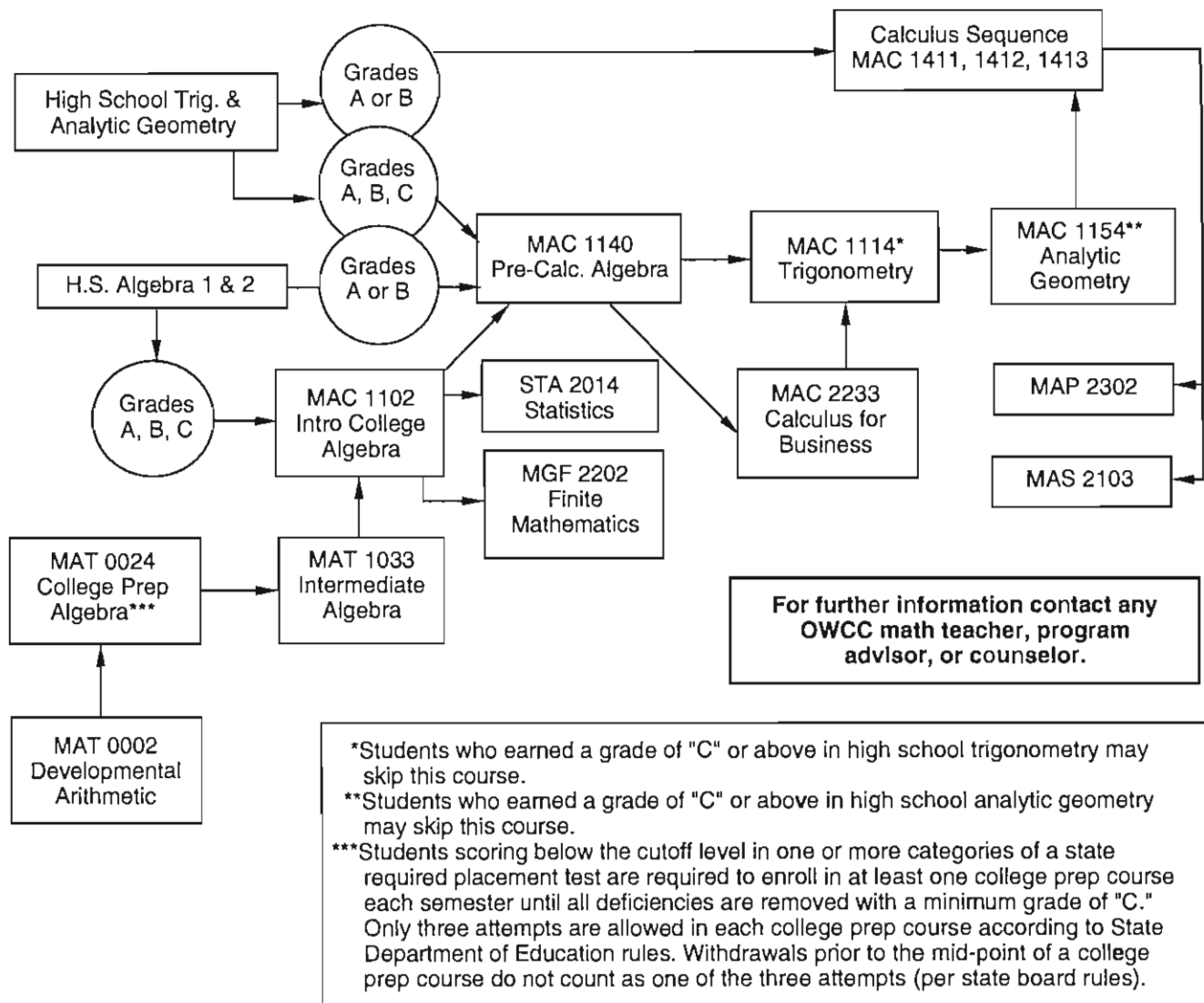

## SPECIAL COMMENTS CONCERNING NURSING

In addition to the Pre-Nursing AA degree program described under the Department of Science, a **career mobility program in nursing** is offered for Licensed Practical Nurses to facilitate earning an Associate of Science degree in Nursing and becoming an RN (also coordinated by the Department of Science). This program is offered through an agreement between Okaloosa-Walton Community College and Pensacola Junior College, and all nursing courses are offered at the OWCC/UWF Campus in Fort Walton Beach with lab assign-

ments in local hospitals. General education courses are provided by OWCC on the Niceville campus and at its various off-campus centers. Persons interested in nursing who do not possess the LPN certificate would be expected to attend selected courses on the PJC Warrington campus.

For further information contact the PJC nursing advisor at the Fort Walton Beach Campus or the OWCC Center Director, telephone 863-6500. Interested persons may also call the PJC Department of Nursing in Pensacola at 484-2278.

## PROGRAMS

Okaloosa-Walton Community College offers two basic degrees which students may pursue for the purpose of completing specific goals: the Associate of Arts degree and the Associate of Science degree, including Applied Science Options. In addition, the college offers occupational certificates and other educational and community services to provide total educational opportunities for the community.

The **Associate of Arts degree** provides full credit for transfer to other institutions for the purpose of satisfying the requirements for a baccalaureate degree.

The **Associate of Science degree** provides the student with college-credit curricula not specifically designed for transfer but designed to prepare persons for semi-professional, technical or managerial employment for advancement in a specific occupational area. Certain public senior institutions in Florida and in other states do accept Associate of Science degree students with full credit for transfer.

Within the Associate of Science degree, the **Applied Science Degree Options** provide the student with college-credit curricula not designed for transfer but designed to provide occupational skills

required for employment and for mid-management and advancements.

Students may earn multiple Associate of Science and AS/Applied Science Option degrees with the specific programs reflected on their diploma and college transcript.

Students may also earn certificates (**local technical awards**) upon completion of one year of skill training (30 to 36 semester hours) in the applied science program areas.

**Continuing Education** courses provide an opportunity to increase occupational efficiency or to become more effective in the use of leisure time. Continuing Education Units (CEU's)\* are earned by completing these experiences. These CEU's allow individuals to accumulate, update, and transfer their records of continuing education evidence of progress made in fulfilling personal improvement goals.

\* One Continuing Education Unit (C.E.U) is ten (10) contact hours of participation in an organized continuing education experience under responsible sponsorship, capable direction, and qualified instruction.

## ASSOCIATE OF ARTS DEGREE PROGRAM REQUIREMENTS

**Associate of Arts** curricula are offered for those students planning to transfer to a four-year institution for the last two years of a bachelor's degree program. SIXTY-FOUR (64) HOURS ARE REQUIRED FOR GRADUATION.

**Courses in Residence.** The minimum is normally 15-semester hours preceding graduation.

**General Education.** The general education program for the Associate of Arts degree at Okaloosa-Walton Community College embraces a minimum of 42-semester hours of academic credit in communications, humanities, social sciences, mathematics, sciences, and physical education as follows on page 46.

**Area of Emphasis:** In addition to the required 42-semester hours of General Education, each student must complete an additional 22-hours in a specialization as listed in this section. Other areas of emphasis may be developed under the guidance of a faculty advisor or counselor and approved by the Vice President for Instruction. NOTE: some areas of emphasis specify more than 22-semester hours. **Students should consult their designated faculty advisor to select the appropriate courses in the specialized field that will fulfill the 64-hour requirement for graduation.**

## **STUDENT BILL OF RIGHTS**

Florida Community College Associate in Arts graduates are guaranteed the following rights under the Statewide Articulation Agreement (State Board of Education Rule 6A-10.024):

1. Admission to one of the state universities, except to limited access\* programs.
2. Acceptance of at least 60 credit hours by the state university toward the baccalaureate degree.
3. Adherence to university requirements and policies based on the catalog in effect at the time the student first entered a community college, provided the student maintains continuous enrollment.
4. Transfer of equivalent courses under the Statewide Course Numbering System.
5. Acceptance by the state universities of credit earned in accelerated programs (e.g., CLEP, AP, PEP, Dual Enrollment, Early Admission and International Baccalaureate).
6. No additional General Education Core requirements.
7. Advance knowledge of selection criteria for limited access programs.
8. Equal opportunity with native university students to enter limited access programs.

Should any guarantee be denied, students have the right of appeal. Each state university and community college shall make available established appeal procedures through the respective articulation officers. At OWCC, students may contact the Vice President for Instruction or the Dean of Student Services.

\*Limited Access is the designation given to programs that require additional admission requirements which are more selective than general admission requirements. These may include the following: increased total GPA and test scores; additional courses and prerequisites; and auditions and portfolios.

## **NOTE — NOTE — NOTE — NOTE — NOTE — NOTE — NOTE — NOTE**

Florida Administrative Code Rules mandate completion of the following actions by all Associate of Arts students prior to receipt of an Associate of Arts degree:

1. **TAKING OF THE COLLEGE LEVEL ACADEMIC SKILLS TEST (CLAST).** Students graduating with an Associate of Arts degree are required to take the CLAST according to the schedules as listed in the Calendar of Instructional Activities in this catalog. The minimum passing scores in effect from August 1, 1986, through July 31, 1989, were as follows: Reading 270, Writing 270, Computation 275, and Essay 4. From August 1, 1989 through September 30, 1991: Reading 295, Writing 295, Computation 285, and Essay 4. From October 1, 1991 through September 30, 1992: Reading 295, Writing 295, Computation 290, and Essay 5. After October 1, 1992, Reading 295, Writing 295, Computation 295 and Essay 6.
2. **TWELVE (12) SEMESTER HOURS WITHIN SPECIFIED COURSES** which require at least six thousand (6,000) words of written work per course. This requirement is met by passing with a "C" twelve (12) hours of English and humanities selected from the courses listed under General Requirements for the Associate of Arts degree.
3. **SIX (6) SEMESTER HOURS OF MATHEMATICS** courses of college algebra or higher. This requirement is met by passing with a "C" six (6) hours of mathematics listed under General Requirements for the Associate of Arts degree.
4. **SLS 1101 (FRESHMAN SEMINAR)** is a recommended course for all entering, full-time (12 credits), AA students. Part-time AA students should take this course in the semester they are enrolled in their 12th credit.

# GENERAL EDUCATION REQUIREMENTS ASSOCIATE OF ARTS DEGREE\*

(42 Semester Hour Minimum)

<u>Sem. Hrs.</u>	<u>Course Selections</u>
Communications Skills .....6	ENC 1101/1102
Humanities .....6	HUM 1020, ARH 1000, MUH 1011, ARH 2050, ARH 2051, PHI 2010, PHI 2600, REL 2300, LIT 2100, LIT 2090, THE 2000, AML 2000, AML 2022, ENL 2011, ENL 2012, THE 2071
Mathematics .....6*	MAC 1102, MAC 1140, MAC 1114, MAC 1154 MAC 1411, MAC 1412, MAC 1413, MAC 2233, MAP 2302, MAS 2103, MGF 2202, STA 2014
Physical Education .....4	No more than four semester hours in PE courses may be used toward meeting general education requirements. HLP 1081 Wellness: Practice and Theory may be used toward satisfying this activity requirement. Any waiver of PE requirements must be made up in general education courses.
Electives .....6	SPC 1600, CGS 1060, foreign language, or others as listed on the following page
Sciences	
Biological .....4-8	BSC 1005 or BOT 1010C or ZOO 1010C or PCB 2011C or BSC 1085C-1086C. Also BSC 1005L when a lab is needed for transfer.
Physical .....4-8	CHM 1020, GLY 1001, 1010C, 1100C, PHY 1020, MET 1010, OCE 1005, AST 1002, CHM 1045C-1046C, PHY 2048C-2049C, PHY 1053C-1054C. Also, GLY 1001L or MET 1010L or OCE 1005L when a lab is needed to complete the minimum 4 credits or for transfer.
Social Science .....6	AMH 2010, 2020, AMH 1041, WOH 1012, 1022, WOH 2040, POT 1002, POS 1041, INR 2002, PSY 2012, SYG 2000, SYG 2010, GEO 1000, ANT 2000, ANT 2100

\* Mathematics courses listed on this page meet the mathematics requirements for FAC Rule 6A-10.030, and credits earned in the fall semester of 1982 or later at OWCC or by transfer shall be based on a minimum grade of "C."

*Oceanography students enjoy a field trip to the Florida State University Marine Lab and a ride on the Gulf of Mexico to trawl for specimens.*





**General Education Electives.** Students who complete the minimum General Education sequence with less than 42-semester hours will have to complete sufficient additional hours from the general education courses previously listed or from the following list of general education electives to reach the 42-semester hours required. In some specializations, specific general education courses are designated and shall be chosen as specifically indicated (exclusive of College Preparatory courses).

CGS 1060 Computer Literacy  
 ECO 2013 Economics I

ECO 2023 Economics II  
 LIN 1670 Writing/Grammar  
 SPC 1600 Speech  
 HUN 2001 Nutrition

**FOREIGN LANGUAGE** – Any college-credit foreign language course.\*

**MATH** – Any degree-credit Math Department courses except:

MAT 0024 College Prep Mathematics  
 MAT 2905 Tutorial  
 MAT 2949 Directed Work Study  
 MGF 2118 Quantitative Skills Seminar

**SCIENCE** – Any college-credit Biological or Physical Science course except the following:

BSC 2946 Directed Work Study – Biology  
 BSC 2905 Tutorial  
 PSC 2906 Directed Work Study – Physical Science

\*The RAISE BILL enacted by the Florida Legislature states that beginning fall, 1987, FOREIGN LANGUAGE CREDITS will be required prior to being admitted to a STATE UNIVERSITY (two years of foreign language in high school or two semesters of foreign language at a community college).



*In Botany lab, hands-on experimentation helps two students learn about plant proteins and how they relate to healthy diets.*

**CUSTOM DESIGNED  
 ASSOCIATE OF ARTS  
 DEGREE PROGRAM**

Specialized, custom-designed programs may be developed to permit individualized planning of curricula to satisfy the first two-year requirements of specialized four-year degree programs. The area of emphasis for these programs would be General Arts & Sciences.

Students seeking a specialized, custom-designed program may request approval by the Vice President for Instruction or the Dean of Technical Education, and Department Chair of any of the following disciplines of a specially designed sequence which, with the OWCC General Education sequence, will meet degree requirements: Business; Consumer Education; Communications; Fine and Performing Arts; Mathematics; Physical Education; Sciences; Social Science; Criminal Justice; and Paralegal.



*OWCC's Manufacturing and Technology programs, including Drafting and Design Technology, Electronics Engineering Technology, and Computer Aided Drafting and Design, maintain successful job placement rates of nearly 100% for students who complete the programs.*

## ATHLETICS & PHYSICAL EDUCATION

Area of Emphasis:

### HEALTH, PHYSICAL EDUCATION AND DANCE

General Education courses selected from those listed for the AA degree on page 46, plus a minimum of 22 semester hours of electives and specialization courses selected with the approval of a faculty advisor from those specified below.

Specific General Education Courses		Sem. Hrs.
EDF 1005	Introduction to Education	3
SPC 1600	Speech	3
PSY 2012	Psychology	3

#### Specialization Courses

HSC 1400	First Aid	3
HSC 1100	Health Education	
PEO 1218	Soft/Baseball Officiating	
PEO 1623	Basketball Officiating	
PET 1020	Introduction to Physical Education	
PET 2622	Athletic Injuries	
HLP 1081	Wellness: Practice and Theory	3

In addition to completing the four (4) hours in activity physical education required for graduation, majors are encouraged to enroll in as many other activity courses deemed pertinent to their specific programs as their academic schedule permits.

## BUSINESS

Area of Emphasis:

### ACCOUNTING

General Education courses selected from those listed for the AA degree on page 46, plus a minimum of 22 semester hours of electives and specialization courses selected with the approval of a faculty advisor from those specified below.

Specialization Courses		Sem. Hrs.
CGS 1060*	Computer Literacy	3
	or	
CIS 1000	DP Concepts	3
STA 2014*	Statistics	3
MTB 1103	Business Math	3
ECO 2013*	Economics I	3
ECO 2023*	Economics II	3
ACG 2001	Accounting I	3
ACG 2011	Accounting II	3
ACG 2071	Managerial Accounting	3
BUL 2241	Business Law I	3
MAC 1140*	Calculus for Business	3
MAN 2021	Management	3
GEB 1011	Introduction to Business	3
CGS 2560	MS-DOS	1
CGS 2510	Introduction to Spreadsheets	2
CGS 2450	Microcomputing for Business	3
CGS 2570	Introduction to Windows	3

Area of Emphasis:

### BANKING

General Education courses selected from those listed for the AA degree on page 46, plus a minimum of 22 semester hours of electives and specialization courses selected with the approval of a faculty advisor from those specified below.

Specialization Courses		Sem. Hrs.
ECO 2013*	Economics I	3
ECO 2023*	Economics II	3
BAN 1004	Principles of Bank Operations	3
ACG 2001	Accounting I	3
ACG 2011	Accounting II	3
BUL 2241	Business Law I	3
BUL 2242	Business Law II	3
BAN 2501	Money and Banking	3
CGS 1060*	Computer Literacy	3
GEB 1011	Introduction to Business	3
ACG 2071	Managerial Accounting	3
CGS 2450	Microcomputing for Business	3
CGS 2570	Introduction to Windows	3

Area of Emphasis:

### BUSINESS ADMINISTRATION AND MANAGEMENT

General Education courses selected from those listed for the AA degree on page 46, plus a minimum of 22 semester hours of electives and specialization courses selected with the approval of a faculty advisor from those specified below.

Specialization Courses		Sem. Hrs.
ECO 2013*	Economics I	3
ECO 2023*	Economics II	3
MAC 1140*	Pre-Calculus Algebra	3
MAC 2233*	Calculus for Business	3
CGS 1060*	Computer Literacy	3
ACG 2001	Accounting I	3
ACG 2011	Accounting II	3
STA 2014*	Statistics	3
BUL 2241	Business Law I	3
BUL 2242	Business Law II	3
MAN 2021	Management	3
MNA 2100	Human Relations	3
MKA 2041	Retail Management	3
OST 2335	Business Communication	3
GEB 1011	Introduction to Business	3
MKA 2021	Salesmanship	3
MKA 2511	Introduction to Advertising	3
MAR 2011	Introduction to Marketing	3
CIS 1000	Data Processing Concepts	3
ACG 2071	Managerial Accounting	3
CGS 2450	Microcomputing for Business	3
CGS 2570	Introduction to Windows	3

\*May be used as General Education courses.

NOTE: Many upper-level university programs recommend that students complete lower division courses in oral communications, college algebra, statistics, accounting, economics, psychology and sociology prior to transfer. Students are urged to check with the institution to which they plan to transfer. Guidance may be received from the business faculty advisor.

Area of Emphasis:

### COMPUTER SCIENCE COMPUTER INFORMATION SYSTEMS OPTION

General Education courses selected from those listed for the AA degree on page 46, plus a minimum of 22 semester hours of electives and specialization courses selected with the approval of a faculty advisor from those specified below.

Specialization Courses	Sem. Hrs.
ECO 2013* Economics I	3
ECO 2023* Economics II	3
MAC 1140* Pre-Calculus Algebra	3
MAC 2233* Calculus for Business	3
STA 2014* Statistics	3
ACG 2001 Accounting I	3
ACG 2011 Accounting II	3
CIS 1000 Data Processing Concepts	3
COP 2120 COBOL Programming	3
COP 2200 FORTRAN Programming	3
COP 2000 Programming I	3
COP 2001 Programming II	3
CGS 2560 Intro. to Microcomputers/MS-DOS	1
MTB 1103 Business Mathematics	3
CGS 1060 Computer Literacy	3
ACG 2071 Managerial Accounting	3
CGS 2450 Microcomputing for Business	3
CGS 2570 Introduction to Windows	3

Area of Emphasis:

### COMPUTER SCIENCE SYSTEMS AND CONTROL ENGINEERING OPTION

General Education courses selected from those listed for the AA degree on page 46, plus a minimum of 22 semester hours of electives and specialization courses selected with the approval of a faculty advisor from those specified below.

Specialization Courses	Sem. Hrs.
MAC 1411* Calculus I	4
MAC 1412* Calculus II	4
MAC 1413* Calculus III	4
PHY 2048C* College Physics I	4
PHY 2049C* College Physics II	4
CIS 1000 Data Processing Concepts	3
COP 2000 Programming I	3
COP 2200 FORTRAN Programming	3
MAP 2302* Differential Equations	3
MAS 2103* Linear Algebra	3
CSG 2560 Intro. to Microcomputers/MS-DOS	1
COP 2001 Programming II	3
CGS 2450 Microcomputing for Business	3
CGS 2570 Introduction to Windows	3

Area of Emphasis:

### HUMAN RESOURCES MANAGEMENT

General Education courses selected from those listed for the AA degree on page 46, plus a minimum of 22 semester hours of electives and specialization courses selected with the approval of a faculty advisor from those specified below.

Specialization Courses	Sem. Hrs.
CGS 1060* Computer Literacy	3
MTB 1103 Business Math	3
MAN 2300 Personnel Management	3
ECO 2013* Economics I	3
ECO 2023* Economics II	3
ACG 2001 Accounting I	3
ACG 2011 Accounting II	3
STA 2014* Statistics	3
BUL 2241 Business Law I	3
BUL 2242 Business Law II	3
MNA 2100 Human Relations	3
OST 2335 Business Communications	3
MAN 2021 Management	3
MNA 1345 Supervision I	3
ACG 2071 Managerial Accounting	3
CGS 2450 Microcomputing for Business	3
CGS 2570 Introduction to Windows	3

Area of Emphasis:

### MARKETING

General Education courses selected from those listed for the AA degree on page 46, plus a minimum of 22 semester hours of electives and specialization courses selected with the approval of a faculty advisor from those specified below.

Specialization Courses	Sem. Hrs.
MAR 2011 Introduction to Marketing	3
MKA 2021 Salesmanship	3
MKA 2511 Introduction to Advertising	3
ECO 2013* Economics I	3
ECO 2023* Economics II	3
ACG 2001 Accounting I	3
ACG 2011 Accounting II	3
STA 2014* Statistics	3
CGS 1060* Computer Literacy	3
MNA 2100 Human Relations	3
MAN 2021 Management	3
MKA 2041 Retail Management	3
CGS 2540 Microcomputing for Business	3
CGS 2570 Introduction to Windows	3

\*May be used as General Education courses.

**Area of Emphasis:**

**REAL ESTATE MANAGEMENT**

General Education courses selected from those listed for the AA degree on page 46, plus a minimum of 22 semester hours of electives and specialization courses selected with the approval of a faculty advisor from those specified below.

Specialization Courses		Sem. Hrs.
MTB 1103	Business Math .....	3
ECO 2013*	Economics I .....	3
ECO 2023*	Economics II .....	3
GEB 1011	Introduction to Business .....	3
REE 1040A	Introduction to Real Estate .....	4
ACG 2001	Accounting I .....	3
ACG 2011	Accounting II .....	3
BUL 2241	Business Law I .....	3
BUL 2242	Business Law II .....	3
STA 2014*	Statistics .....	3
CGS 1060*	Computer Literacy .....	3
OST 2335	Business Communications .....	3
MKA 2021	Salesmanship .....	3
MAR 2021	Marketing .....	3
MAN 2021	Management .....	3
ACG 2071	Managerial Accounting .....	3
CGS 2540	Microcomputing for Business .....	3
CGS 2570	Introduction to Windows .....	3

\*May be used as General Education courses.

**COMMUNICATIONS**

**Area of Emphasis:**

**FOREIGN LANGUAGE**

General Education courses selected from those listed for the AA degree on page 46, plus a minimum of 22 semester hours of electives and specialization courses selected with the approval of a faculty advisor from those specified below.

Specialization Courses (Select courses in one language to fulfill the 64 semester hours graduation requirements. Special programs in multiple languages may be developed in cooperation with a foreign language advisor.)

Specific General Education Courses		Sem. Hrs.
<b>French</b>		
FRE 1120	French I .....	4
FRE 1121	French II .....	4
FRE 2200	French III .....	4
FRE 2201	French IV .....	4
FRE 2100	Introduction to French Literature I .....	3
FRE 2101	Introduction to French Literature II .....	3

\*Some universities will allow a combination of the following three courses to waive a Psychological Foundations class. The courses are PSY 2012, EDP 2002, and either DEP 2004 or CHD 1230. Please check with your advisor.

**Spanish**

SPN 1120	Spanish I .....	4
SPN 1121	Spanish II .....	4
SPN 2200	Spanish III .....	4
SPN 2201	Spanish IV .....	4
SPN 2300	Advanced Spanish Grammar and Composition I .....	3
SPN 2301	Advanced Spanish Grammar and Composition II .....	3
SPW 2100	Introduction to Spanish Literature I .....	3
SPW 2101	Introduction to Spanish Literature II .....	3

**Area of Emphasis:**

**TEACHER EDUCATION – ELEMENTARY\***

General Education courses selected from those listed for the AA degree on page 46, plus a minimum of 22 semester hours of electives and specialization courses selected with the approval of a faculty advisor from those specified below.

Specific General Education Courses		Sem. Hrs.
SPC 1600	Speech .....	3
PSY 2012	Psychology .....	3

**Specialization Courses**

EDF 1005	Introduction to Education .....	3
EDP 2002	Educational Psychology .....	3
DEP 2004	Human Growth and Development .....	3
	or	
CHD 1230	Child Growth and Development II .....	3
	Foreign Languages .....	8

**Recommended Electives – Elementary**

Courses that will enhance the students art and music background such as MUT 1001 – Fundamentals of Music.

Courses from Early Childhood Education area of emphasis (see page 51.)

Courses selected from the general education program of the Humanities, Communications, Math, Science, or Social Science.

**Area of Emphasis:**

**TEACHER EDUCATION – SECONDARY\***

General Education courses selected from those listed for the AA degree on page 46, plus a minimum of 22 semester hours of electives and specialization courses selected with the approval of a faculty advisor from those specified below.

Specific General Education Courses		Sem. Hrs.
SPC 1600	Speech .....	3
PSY 2012	Psychology .....	3

**Specialization Courses**

EDF 1005	Introduction to Education .....	3
	Foreign Languages .....	8
HUS 1400A	Peer Advising .....	3

**Recommended Electives – Secondary**

Courses that will enhance the student's area of concentration.



**Area of Emphasis:**

**EARLY CHILDHOOD EDUCATION**

General Education courses selected from those listed for the AA degree on page 46, plus a minimum of 22 semester hours of electives and specialization courses selected with the approval of a faculty advisor from those specified below.

Specialization Courses	Sem. Hrs.
CHD1220 Child Growth and Development I	.....3
CHD 1230 Child Growth and Development II	.....3
CHD 1430 Observing and Recording Child Behavior	.....3
CHD 1800 Early Childhood Program Administration	.....3
CHD 2322 Programming for Young Children	.....3
CHD 2432A Curriculum for Young Children	.....3
HOE 1010 Introduction to Home Economics	.....3
HUN 2410A Child Nutrition and Health	.....3
or	
HUN 2001 Nutrition	.....3
EDF 1005 Introduction to Education	.....3

**Area of Emphasis:**

**FASHION MERCHANDISING**

General Education courses selected from those listed for the AA degree on page 46, plus a minimum of 22 semester hours of electives and specialization courses selected with the approval of a faculty advisor from those specified below.

Specialization Courses	Sem. Hrs.
CTE 1401 Textiles	.....3
COA 2100 Consumer Education	.....3
MAR 2011 Introduction to Marketing	.....3
MKA 2041 Retail Management	.....3
MKA 2511 Advertising	.....3
MKA 2021 Salesmanship	.....3
CTE 1204 Wardrobe Imaging	.....3



**Area of Emphasis:**

**HOME ECONOMICS EDUCATION**

General Education courses selected from those listed for the AA degree on page 46, plus a minimum of 22 semester hours of electives and specialization courses selected with the approval of a faculty advisor from those specified below.

Specialization Courses	Sem. Hrs.
HOE 1010 Introduction to Home Economics	.....3
COA 2100 Consumer Education	.....3
HUN 2001 Nutrition	.....3
CHD 1220 Child Growth and Development I	.....3
HHD 2110 Home Planning and Furnishings	.....3
FSS 1210C Family Meal Planning	.....3
CTE 1401 Textiles	.....3
CTE 1204 Wardrobe Imaging	.....3

**Area of Emphasis:**

**HOUSING AND INTERIOR DESIGN**

General Education courses selected from those listed for the AA degree on page 46, plus a minimum of 22 semester hours of electives and specialization courses selected with the approval of a faculty advisor from those specified below.

Specialization Courses	Sem. Hrs.
HOE 1010 Introduction to Home Economics	.....3
COA 2100 Consumer Education	.....3
HHD 2110 Home Planning and Furnishings	.....3
CTE 1401 Textiles	.....3
ART 1201C Design I	.....3
TAR 2121C Architectural Drafting	.....3
EGS 1110C Engineering Graphics	.....3

**Area of Emphasis:**

**NUTRITION AND DIETETICS**

General Education courses selected from those listed for the AA degree on page 46, plus a minimum of 22 semester hours of electives and specialization courses selected with the approval of a faculty advisor from those specified below.

Specialization Courses	Sem. Hrs.
HUN 2001 Nutrition	.....3
BSC 1805C Human Anatomy and Physiology	.....4
COA 2100 Consumer Education	.....3
MAN 2021 Management	.....3
HOE 1010 Introduction to Home Economics	.....3
HUN 2410A Child Nutrition and Health	.....3
FSS 1210C Family Meal Planning	.....3

*Free tutoring, tutorial software, and videotapes covering individual course objectives are available for students in the Math Lab. Tutoring in a variety of subjects is also available at the Academic Success Center.*



## HUMANITIES, FINE & PERFORMING ARTS

**Area of Emphasis:**

### ART

General Education courses selected from those listed for the AA degree on page 46, plus a minimum of 22 semester hours of electives and specialization courses selected with the approval of a faculty advisor from those specified below.

Specific General Education Courses	Sem. Hrs.
ARH 2050 Art History: Prehistory Renaissance .....	3
ARH 2051 Art History: Renaissance — 20th Century .....	3

**Specialization Courses**

ART 1300C Drawing I .....	3
ART 1301C Drawing II .....	3
ART 1201C Design I (2 Dimensional) .....	3
ART 1203C Design II (3 Dimensional) .....	3

**Art Electives (Any four of the following courses):**

ART 1110C Pottery I .....	3
ART 1111C Pottery II .....	3
ART 1701C Sculpture I .....	3
ART 1702C Sculpture II .....	3
ART 2510C Painting I .....	3
ART 2520C Painting II .....	3
ART 2560C Watercolor I .....	3
ART 2561C Watercolor II .....	3
ART 1430C Screen Printing I .....	3
ART 1431C Screen Printing II .....	3

**Area of Emphasis:**

### HUMANITIES

General Education courses selected from those listed for the AA degree on page 46, plus a minimum of 22 semester hours of electives and specialization courses selected with the approval of a faculty advisor from those specified below.

Specific General Education Courses	Sem. Hrs.
HUM 1020 Humanities – Introduction .....	3
PHI 2010 Humanities – Philosophy .....	3
REL 2300 Humanities – Comparative Religion .....	3
ARH 2050 Art History Survey I .....	3
ARH 2051 Art History Survey II .....	3
ARH 1000 Humanities Art .....	3
MUH 1011 Humanities Music .....	3
THE 2000 Theatre .....	3
LIT 2100 World Literature .....	3

**Other Specialization Courses**

Electives as needed in specific arts and humanities courses from area(s) of weakness and special interests:

**Art Labs**

ART 1300C, ART 1301C, ART 1110C, ART 1111C, ART 1201C, ART 1203C, ART 1701C, ART 2510C, ART 2520C.

**Area of Emphasis:**

### MINISTRY

General Education courses selected from those listed for the AA degree on page 46, plus a minimum of 22 semester hours of electives and specialization courses selected with the approval of a faculty advisor from those specified below.

Specific General Education Courses	Sem. Hrs.
PHI 2010 Humanities – Philosophy .....	3
REL 2300 Humanities – Comparative Religion .....	3
SPC 1600 Speech .....	3
LIT 2100 World Literature .....	3
PSY 2012 Psychology .....	3
SYG 2000 Sociology .....	3

NOTE: Ministry electives should be selected according to goals of the student's individual program. Electives may vary due to area (e.g., evangelical, pastorate, music ministry, religious education, etc.) and denominational emphasis or needs.

**Area of Emphasis:**

### MUSIC

General Education courses selected from those listed for the AA degree on page 46, plus a minimum of 22 semester hours of electives and specialization courses selected with the approval of a faculty advisor from those specified below.

Specialization Courses	Sem. Hrs.
MUT 1001 Music Fundamentals (if needed) .....	3
MUH 1011 Humanities – Music .....	3
MUT 1121 Music Theory I .....	3
MUT 1122 Music Theory II .....	3
MUT 2126 Music Theory III .....	3
MUT 2127 Music Theory IV .....	3
MVK 1211 Applied Piano I .....	1-4
MVK 2221 Applied Piano II .....	1-4
MVV 1211 Applied Voice I .....	1-4
MVV 2221 Applied Voice II .....	1-4
Applied instrument courses as needed	
Applied ensemble courses as needed	



## MATHEMATICS

Area of Emphasis:

### ENGINEERING

General Education courses selected from those listed for the AA degree on page 46, plus a minimum of 22 semester hours of electives and specialization courses selected with the approval of a faculty advisor from those specified below.

Specific General Education Courses	Sem. Hrs.
MAC 1411* Calculus I	4
MAC 1412 Calculus II	4
CHM 1045C College Chemistry I	4
CHM 1046C College Chemistry II	4
PHY 2048C College Physics I	4
PHY 2049C College Physics II	4

#### Specialization Courses

MAP 2302 Differential Equations	3
MAS 2103 Linear Algebra	3
EGS 1110C Engineering Graphics	3
EGS 1130C Descriptive Geometry	3
MAC 1413 Calculus III	4

NOTE: The courses CIS 1000, COP 2000, and COP 2200 should be taken if time permits. Students will need to identify the college or university to which they plan to transfer plus the branch of engineering to permit proper course selection.

Area of Emphasis:

### MATHEMATICS (METEOROLOGY)

General Education courses selected from those listed for the AA degree on page 46, plus a minimum of 22 semester hours of electives and specialization courses selected with the approval of a faculty advisor from those specified below.

Specific General Education Courses	Sem. Hrs.
MAC 1411* Calculus I	4
MAC 1412 Calculus II	4
CHM 1045C College Chemistry I	4
CHM 1046C College Chemistry II	4
PHY 2048C College Physics I	4
PHY 2049C College Physics II	4

#### Specialization Courses

MAP 2302 Differential Equations	3
MAC 1413 Calculus III	4
MAS 2103 Linear Algebra	3
MET 1010 Introduction to Meteorology	3

NOTE: The courses CIS 1000, COP 2000, and COP 2200 should be taken if time permits.

Area of Emphasis:

### MATHEMATICS EDUCATION (Secondary Certification)

General Education courses selected from those listed for the AA degree on page 46, plus a minimum of 22 semester hours of electives and specialization courses selected with the approval of a faculty advisor from those specified below.

Specific General Education Courses	Sem. Hrs.
MAC 1411* Calculus I	4
MAC 1412 Calculus II	4
PHY 1053C Physics I	4
PHY 1054C Physics II	4

#### Specialization Courses

MAC 1413 Calculus III	4
Foreign Language	8



## SCIENCES

### Biological and Physical

Area of Emphasis:

### BIOLOGY (MARINE, FORESTRY, TEACHER EDUCATION)

General Education courses selected from those listed for the AA degree on page 46, plus a minimum of 22 semester hours of electives and specialization courses selected with the approval of a faculty advisor from those specified below.

Specific General Education Courses	Sem. Hrs.
CHM 1045C College Chemistry I	4
CHM 1046C College Chemistry II	4
BOT 1010C Botany	4
ZOO 1010C Zoology	4
MAC 1411 Calculus I	4

#### Specialization Courses

Foreign Language Recommended	
CHM 2210C Organic Chemistry I	4
CHM 2211C Organic Chemistry II	4
PCB 2011C Cell Biology	4

#### Select one course from the following:

MCB 2013C Microbiology	4
ECO 2013 Economics I (Forestry only)	3

\* Other mathematics courses may be needed to prepare for MAC 1411.

**Area of Emphasis:**

**CHEMISTRY**

General Education courses selected from those listed for the AA degree on page 46, plus a minimum of 22 semester hours of electives and specialization courses selected with the approval of a faculty advisor from those specified below.

Specific General Education Courses		Sem. Hrs.
CHM 1045C	College Chemistry I .....	4
CHM 1046C	College Chemistry II .....	4
BOT 1010C	Botany .....	4
ZOO 1010C	Zoology .....	4
MAC 1411*	Calculus I .....	4

Specialization Courses		Sem. Hrs.
MAC 1412	Calculus II .....	4
MAC 1413	Calculus III .....	4
CHM 2210C	Organic Chemistry I .....	4
CHM 2211C	Organic Chemistry II .....	4
PHY 2048C	College Physics I .....	4
PHY 2049C	College Physics II .....	4
MAP 2302	Differential Equations .....	3

**Area of Emphasis:**

**GEOLOGY (HYDROLOGY)**

General Education courses selected from those listed for the AA degree on page 46, plus a minimum of 22 semester hours of electives and specialization courses selected with the approval of a faculty advisor from those specified below.

Specific General Education Courses		Sem. Hrs.
GLY 1010C	Physical Geology .....	4
GLY 1100C	Historical Geology .....	4
MAC 1411*	Calculus I .....	4
MAC 1412	Calculus II .....	4

Specialization Courses		Sem. Hrs.
CHM 1045C	College Chemistry I .....	4
CHM 1046C	College Chemistry II .....	4
PHY 2048C	College Physics I .....	4
PHY 2049C	College Physics II .....	4
MAC 1413	Calculus II .....	4

\*Other mathematics courses may be needed to prepare for MAC 1411.

NOTE: Not all university programs have the same requirements. See your advisor for the specific requirements for a given school.

**Area of Emphasis:**

**MEDICAL TECHNOLOGY\***

General Education courses selected from those listed for the AA degree on page 46, plus a minimum of 22 semester hours of electives and specialization courses selected with the approval of a faculty advisor from those specified below.

Specific General Education Courses		Sem. Hrs.
CHM 1045C	College Chemistry I .....	4
CHM 1046C	College Chemistry II .....	4
PCB 2011C	Cell Biology .....	4
ZOO 1010C	Zoology .....	4

Specialization Course		Sem. Hrs.
	Foreign Language .....	8
BSC 1085C	Anatomy and Physiology I .....	4
BSC 1086C	Anatomy and Physiology II .....	4
MCB 2013C	Microbiology .....	4
CHM 2210C	Organic Chemistry I .....	4
CHM 2211C	Organic Chemistry II .....	4

\*The proper selection of courses in this program is very important. Any student planning to major in this program at a senior institution should get a catalog from the institution to develop an appropriate program at OWCC.

**Area of Emphasis:**

**PREPHYSICAL THERAPY\***

General Education courses selected from those listed for the AA degree on page 46, plus a minimum of 22 semester hours of electives and specialization courses selected with the approval of a faculty advisor from those specified below.

Specific General Education Courses		Sem. Hrs.
CHM 1045C	College Chemistry I .....	4
CHM 1046C	College Chemistry II .....	4
ZOO 1010C	Zoology .....	4
PCB 2011C	Cell Biology .....	4
PSY 2012	Psychology .....	3
MAC 1411	Calculus I .....	4
SYG 2000	Sociology .....	3

Specialization Courses		Sem. Hrs.
PHY 2048C**	College Physics I .....	4
PHY 2049C**	College Physics II .....	4
or		
PHY 1053C**	Physics I .....	4
PHY 1054C**	Physics II .....	4

**Select one course from the following:**

CLP 2140	Abnormal Psychology .....	3
DEP 2004	Human Growth and Development .....	3

\*The proper selection of courses in this program is critical since this is a limited access program at most universities. Obtain a catalog from the senior institution and select the appropriate courses in cooperation with an OWCC faculty advisor.

\*\*Depending upon university requirements.



**Area of Emphasis:****PHYSICS \***

General Education courses selected from those listed for the AA degree on page 46, plus a minimum of 22 semester hours of electives and specialization courses selected with the approval of a faculty advisor from those specified below.

Specific General Education Courses		Sem. Hrs.
MAC 1411**	Calculus I .....	4
CHM 1045C	College Chemistry I .....	4
Specialization Courses		
MAC 1412	Calculus II .....	4
MAC 1413	Calculus III .....	4
MAS 2103	Linear Algebra .....	3
MAP 2302	Differential Equations .....	3
CHM 1046C	College Chemistry II .....	4
PHY 2048C	College Physics I .....	4
PHY 2049C	College Physics II .....	4

\* See departmental advisor for options and substitutions.

\*\* Other mathematics courses may be needed to prepare for MAC 1411.

NOTE: Introduction to Computer Programming, COP 2000, and other computer courses are recommended if time permits.

**Area of Emphasis:****PRENURSING\***

General Education courses selected from those listed for the AA degree on page 46, plus a minimum of 22 semester hours of electives and specialization courses selected with the approval of a faculty advisor from those specified below.

Specific General Education Courses		Sem. Hrs.
CHM 1045C	College Chemistry I .....	4
CHM 1046C	College Chemistry II .....	4
PSY 2012	Psychology .....	3
SYG 2000	Sociology .....	3
ZOO 1010C	Zoology .....	4
PCB 2011C	Cell Biology .....	4

**Specialization Courses**

HUN 2001	Nutrition .....	3
DEP 2004	Human Growth Development .....	3
MCB 1000C	Microbiology/Allied Health .....	4
BSC 1085C	Anatomy & Physiology I .....	4
BSC 1086C	Anatomy & Physiology II .....	4

\* The proper selection of courses in this program is critical since this is a limited access program at most universities. Obtain a catalog from the senior institution and select the appropriate courses in cooperation with an OWCC faculty advisor.

**Area of Emphasis:****PREPHARMACY**

General Education courses selected from those listed for the AA degree on page 46, plus a minimum of 22 semester hours of electives and specialization courses selected with the approval of a faculty advisor from those specified below.

Specific General Education Courses		Sem. Hrs.
CHM 1045C	College Chemistry I .....	4
CHM 1046C	College Chemistry II .....	4
BOT 1010C	Botany .....	4
ZOO 1010C	Zoology .....	4
MAC 1411	Calculus I .....	4

**Specialization Courses**

	Foreign Language .....	8
CHM 2210C	Organic Chemistry I .....	4
CHM 2211C	Organic Chemistry II .....	4
PCB 2011C	Cell Biology .....	4
ECO 2013	Economics I .....	3
PHY 2048C**	College Physics I .....	4
PHY 2049C**	College Physics II .....	4
	or	
PHY 1053C**	Physics I .....	4
PHY 1054C**	Physics II .....	4

**Area of Emphasis:****PREPROFESSIONAL  
(MEDICINE, VETERINARY,  
DENTISTRY)**

General Education courses selected from those listed for the AA degree on page 46, plus a minimum of 22 semester hours of electives and specialization courses selected with the approval of a faculty advisor from those specified below.

Specific General Education Courses		Sem. Hrs.
CHM 1045C	College Chemistry I .....	4
CHM 1046C	College Chemistry II .....	4
PCB 2011C	Cell Biology .....	4

**Specialization Courses**

	Foreign Language .....	8
CHM 2210C	Organic Chemistry I .....	4
CHM 2211C	Organic Chemistry II .....	4
BOT 1010C	Botany .....	4
MAC 1411*	Calculus .....	4
MCB 2013C	Microbiology .....	4
PHY 2048C**	College Physics I .....	4
PHY 2049C**	College Physics II .....	4
	or	
PHY 1053C**	Physics I .....	4
PHY 1054C**	Physics II .....	4

\* Other mathematics courses may be needed to prepare for MAC 1411.

\*\* Depending upon university/medical school requirements.

## PUBLIC SAFETY

## Area of Emphasis:

**CRIMINAL JUSTICE**

General Education courses selected from those listed for the AA degree on page 46, plus a minimum of 22 semester hours of electives and specialization courses selected with the approval of a faculty advisor from those specified below.

Required Core Courses: 18 Hours		Sem. Hrs.
CCJ 1000	Introduction to Criminology .....	3
CCJ 1020	Introduction to Criminal Justice .....	3
CCJ 1210	Criminal Law .....	3
CJD 1930	Human Diversity .....	3
CCJ 1500	Juvenile Delinquency .....	3
CCJ 1935	Criminal Justice Seminar .....	3
Electives		
CCJ 1400	Police Organization and Administration .....	3
CCJ 2070	Computer Applications in Criminal Justice .....	3
CCJ 2300	Introduction to Corrections .....	3
CCJ 2330	Introduction to Probation & Parole .....	3
CCJ 2905	Independent Study – Criminal Justice .....	1
CJD 1420	Correctional Law .....	3
CCJ 1230	Criminal Procedures .....	3
CJD 2605	Traffic Homicide .....	3
PLA 2263	Rules of Evidence .....	3
PLA 1105	Legal Research .....	3

NOTE: Students must see a Criminal Justice advisor to select the proper elective courses and to develop a plan for completing the degree total of 64 semester hours. Students interested in Prelaw should also see a Criminal Justice advisor.

## Area of Emphasis:

**PARALEGAL/LEGAL ASSISTANT**

General Education courses selected from those listed for the AA degree on page 46, plus a minimum of 22 semester hours of electives and specialization courses selected with the approval of a faculty advisor from those specified below.

Required Core Courses: 18 hours		Sem. Hrs.
PLA 1003	Introduction to Paralegalism .....	3
PLA 1105	Legal Research .....	3
PLA 2263	Rules of Evidence .....	3
CCJ 1210	Criminal Law .....	3
CCJ 1230	Criminal Procedures .....	3
PLA 1203	Introduction to Civil Law .....	3
Electives		
PLA 1803	Family Law .....	3
PLA 2273	TORTS: Injury .....	3
PLA 1051	Legal Terminology .....	3
PLA 1460	Bankruptcy Law .....	3
BUL 2241	Business Law I .....	3
BUL 2242	Business Law II .....	3

NOTE: Students should see an advisor to select the proper elective courses and to develop a plan for completing the degree total of 64 semester hours. Students interested in prelaw should also see an advisor.

## SOCIAL SCIENCE

## Area of Emphasis:

**SOCIAL SERVICES**

General Education courses selected from those listed for the AA degree on page 46, plus a minimum of 22 semester hours of electives and specialization courses selected with the approval of a faculty advisor from those specified below.

Select two of the following courses:		Sem. Hrs.
PHI 2010	Humanities – Philosophy .....	3
REL 2300	Humanities – Comparative Religion .....	3
LIT 2100	Approach to Literature .....	3

**Specialization Courses**

	Foreign Language .....	12
CLP 1002	Personal Adjustment .....	3
CCJ 1000	Intro. to Criminology .....	3
CCJ 1020	Introduction to Criminal Justice .....	3
SYG 2430	Family and Society .....	3
POT 1002	History and Ideas of Political Science .....	3
CCJ 2300	Intro. to Corrections .....	3
PSY 2012	Psychology .....	3
CCJ 1210	Criminal Law .....	3
SYG 2000	Sociology .....	3
CCJ 1230	Criminal Procedures .....	3
CCJ 1500	Juvenile Delinquency .....	3

## Area of Emphasis:

**SOCIAL SCIENCES**

General Education courses selected from those listed for the AA degree on page 46, plus a minimum of 22 semester hours of electives and specialization courses selected with the approval of a faculty advisor from those specified below.

Specific General Education Courses		Sem. Hrs.
BSC 1005	General Biology .....	4

Select two of the following courses:		
PHI 2010	Humanities – Philosophy .....	3
REL 2300	Humanities – Comparative Religion .....	3
LIT 2100	Approach to Literature .....	3

**Specialization Courses**

CLP 1002	Personal Adjustment .....	3
CCJ 1000	Intro. to Criminology .....	3
SYG 2430	Family and Society .....	3
DEP 2004	Human Growth and Development .....	3
CCJ 2300	Intro. to Corrections .....	3
INR 2002	Current World Problems .....	3
POT 1002	History and Ideas of Political Science .....	3
PSY 2012	Psychology .....	3
SYG 2000	Sociology .....	3
CCJ 1230	Criminal Procedures .....	3
CCJ 1500	Juvenile Delinquency .....	3



# ASSOCIATE OF SCIENCE DEGREE PROGRAM REQUIREMENTS

Associate of Science Degree programs provide specialization in technical, business, semi-professional, and supervisory education. Okaloosa-Walton Community College has developed programs for such studies. Programs include study and practical applications, and students may earn AS degrees in multiple OWCC programs. SIXTY-FOUR (64) HOURS ARE REQUIRED FOR GRADUATION.

**Courses in Residence.** Minimum requirement of courses taken in residence for an Associate of Science Degree is normally 15 semester hours of credit immediately preceding graduation.

**General Education.** The general education program for the Associate of Science Degree embraces a minimum of 26 semester hours of academic credit in the areas of communications, humanities, social science, mathematics, science, and physical education, as follows (see page 58):

**Area of Emphasis.** In addition to the required 26 semester hours of General Education, each student must complete an additional 38 to 46 semester hours in a specialization as listed in this section. Students should consult their designated faculty advisor to select the appropriate courses in the specialized field that will fulfill the degree requirements.

**NOTE — NOTE — NOTE — NOTE — NOTE — NOTE — NOTE — NOTE — NOTE**

Florida Administrative Code Rules require that all students receiving an Associate of Science Degree and planning to transfer to a state university shall take and pass the College Level Academic Skills Test according to the schedule as listed in the Calendar of Instructional Activities in this catalog.

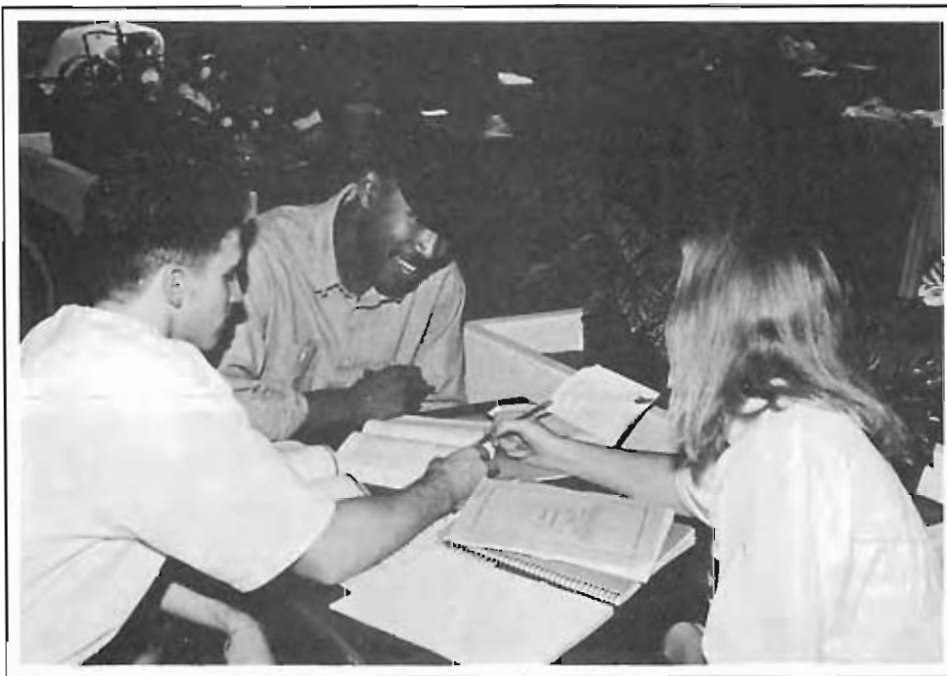

*The College Mall on the Niceville Campus has a cafeteria, bookstore, game room, art gallery, and performance stage and is a great place for informal discussions and visiting with friends.*

# GENERAL EDUCATION REQUIREMENTS ASSOCIATE OF SCIENCE DEGREE (26 Semester Hour Minimum)

	Sem. Hrs.	
Communication Skills .....	6	ENC 1101, 1102, LIN 1670
Humanities .....	3	HUM 1020, ARH 1000, MUH 1011, ARH 2050, 2051, PHI 2010, PHI 2600, REL 2300, LIT 2090, 2100, THE 2000, AML 2000, AML 2022, ENL 2011, ENL 2012, THE 2071
Mathematics .....	3	MAC 1102, 1140, 1114, 1154, 1411, 1412, 1413, 2233, MAT 1033, MAP 2302, MAS 2103, MTB 1103, MGF 2202, STA 2014, MTB 1321, 1322
Physical Education .....	4*	Any designated activity sport courses as specified under graduation requirements on page 36 unless exempted.
Science (Biological and Physical) .....	4-8	CHM 1020, PHY 1020, GLY 1001, PHY 1053C, 1054C, BSC 1005, MET 1010/OCE 1005, CHM 1045C/1046C
Social Science .....	3	AMH 2010, 2020, AMH 1041, WOH 1012, 1022, WOH 2040, POT 1002, POS 1041, INR 2002, PSY 2012, SYG 2000, SYG 2010, GEO 1000, ANT 2000, ANT 2100
Approved Electives .....	3	CGS 1060, SPC 1600, or other courses meeting A.A. General Elective requirements.

**Specialization.** To complete requirements for graduation, each student must have earned at least 64 semester hours of credit with a minimum of 26 in the general education sequence and an approximate total of 38 in a specialization. Other general education courses listed for the AA degree may be taken to satisfy the above requirements.

Self-contained curricula are offered by the departments for students seeking to prepare for entry-level positions in a career field upon complete of the Associate of Science Degree.

Students desiring to complete an Associate of Science Degree may in consultation with a faculty advisor select one of the following specializations:

\*Maximum to be included in the 64 hours required for the degree.

*Technical Education at OWCC includes an occupational certificate program in Business. Students may study marketing, management, accounting technology, real estate management, or other business fields. These students work on word processing skills in the Business department's open computer lab.*



Area of Emphasis:

**ACCOUNTING TECHNOLOGY**

(CIP 0507.010100)

General Education courses selected from those listed for the AS degree on page 58, plus from 38 to 46 semester hours of electives and specialization courses selected with the approval of a faculty advisor from those specified below.

Specialization Courses	Sem. Hrs.
CGS 1060 Computer Literacy .....	3
or	
CIS 1000 DP Concepts .....	3
MTB 1103 Business Math .....	3
ECO 2013 Economics I .....	3
ACG 2001 Accounting I .....	3
ACG 2011 Accounting II .....	3
ACG 2071 Managerial Accounting .....	3
BUL 2241 Business Law I .....	3
GEB 1011 Intro. to Business .....	3
CGS 2560 MS-DOS .....	1
OST 2335 Business Communications .....	3
MAC 2233 Calculus for Business .....	3
MAN 2021 Management .....	3
TAX 2000 Federal Income Tax: Ind. ....	3
CGS 2450 Microcomputing for Business .....	3
CGS 2570 Introduction to Windows .....	3

Area of Emphasis:

**BUSINESS ADMINISTRATION AND MANAGEMENT**

(CIP 0506.049901)

General Education courses selected from those listed for the AS degree on page 58, plus from 38 to 46 semester hours of electives and specialization courses selected with the approval of a faculty advisor from those specified below.

Specialization Courses	Sem. Hrs.
GEB 1011 Introduction to Business .....	3
BUL 2241 Business Law I .....	3
MNA 2100 Human Relations .....	3
CGS 1060 Computer Literacy .....	3
MAR 2011 Introduction to Marketing .....	3
ACG 2001 Accounting I .....	3
ACG 2011 Accounting II .....	3
BUL 2242 Business Law II .....	3
OST 2335 Business Communications .....	3
MAN 2021 Management .....	3
ECO 2013 Economics I .....	3
MTB 1103 Business Math .....	3
MAN 2300 Personnel Management .....	3
ACG 2071 Managerial Accounting .....	3
CGS 2450 Microcomputing for Business .....	3
CGS 2570 Introduction to Windows .....	3
Business Elective .....	3
MKA 2041 Retail Management .....	3
MAR 2011 Introduction to Marketing .....	3
MKA 2511 Introduction to Advertising .....	3
MKA 2021 Salesmanship .....	3

Area of Emphasis:

**BUSINESS ADMINISTRATION AND MANAGEMENT (BANKING OPTION)**

(CIP 0506.049901)

General Education courses selected from those listed for the AS degree on page 58, plus from 38 to 46 semester hours of electives and specialization courses selected with the approval of a faculty advisor from those specified below.

Required Specialization Courses

OWCC Course	AIB Course	Title	Sem. Hrs.
ACG 2001	1000	Accounting I .....	3
BAN 2500	2310	Economics for Bankers .....	3
BAN 2800	3660	Law and Banking .....	3
BAN 2511	7740	Marketing for Bankers .....	3
BAN 2501	1350	Money and Banking .....	3
BAN 1004	1370	Principles of Banking .....	3
CGS 2450		Microcomputing for Business .....	3
CGS 2570		Introduction to Windows .....	3
BAN 2531	4265	Introduction to Supervision ..	1

**ELECTIVE SPECIALIZATION COURSES**

Remaining specialization courses are selected from the approved list .....13

Area of Emphasis:

**COMPUTER PROGRAMMING AND ANALYSIS**

(CIP 0507.030500)

General Education courses selected from those listed for the AS degree on page 58, plus from 38 to 46 semester hours of electives and specialization courses selected with the approval of a faculty advisor from those specified below.

Specialization Courses	Sem. Hrs.
GEB 1011 Introduction to Business .....	3
STA 2014 Statistics .....	3
ACG 2001 Accounting I .....	3
ACG 2011 Accounting II .....	3
CIS 1000 Data Processing Concepts .....	3
COP 2000 Programming I .....	3
COP 2001 Programming II .....	3
COP 2120 COBOL Programming .....	3
COP 2200 FORTRAN Programming .....	3
ECO 2013 Economics I .....	3
ECO 2023 Economics II .....	3
CGS 2510 Electronic Spreadsheets .....	2
CGS 2540 dBase III .....	2
CGS 2560 Intro. to Microcomputers/MS-DOS .....	1
MTB 1103 Business Mathematics .....	3
CGS 2450 Microcomputing for Business .....	3
CGS 2570 Introduction to Windows .....	3

Area of Emphasis:

## HUMAN RESOURCES MANAGEMENT

(CIP 0506.049901)

General Education courses selected from those listed for the AS degree on page 58, plus from 38 to 46 semester hours of electives and specialization courses selected with the approval of a faculty advisor from those specified below.

Specialization Courses	Sem. Hrs.
CGS 1060	Computer Literacy .....3
MTB 1103	Business Math .....3
MAN 2300	Personnel Management .....3
ECO 2013	Economics I .....3
ACG 2001	Accounting I .....3
ACG 2011	Accounting II .....3
BUL 2241	Business Law I .....3
BUL 2242	Business Law II .....3
MNA 2100	Human Relations .....3
OST 2335	Business Communications .....3
GEB 1011	Introduction to Business .....3
MAN 2021	Management .....3
ACG 2071	Managerial Accounting .....3
CGS 2450	Microcomputing for Business .....3
CGS 2570	Introduction to Windows .....3
	Business Elective .....3

Area of Emphasis:

## INDUSTRIAL MANAGEMENT TECHNOLOGY

(CIP 0606.200101)

General Education courses selected from those listed for the AS degree on page 58, plus from 38 to 46 semester hours of electives and specialization courses selected with the approval of a faculty advisor from those specified below.

Specialization Courses	Sem. Hrs.
MNA 1015	Industrial Management I .....3
MNA 2301	Industrial Management II .....3
MNA 1345	Supervision I .....3
MNA 1346	Supervision II .....3
ACG 2001	Accounting I .....3
MAR 2011	Marketing .....3
OST 2335	Business Communications .....3
MNA 2100	Human Relations .....3
MTB 1103	Business Math .....3
CGS 1060	Computer Literacy .....3
MAN 2300	Personnel Management .....3
CGS 2450	Microcomputing for Business .....3
CGS 2570	Introduction to Windows .....3
	Approved Technical Electives .....5

\*Students will be admitted to the levels of typewriting and shorthand for which they are qualified; OST 2120 and OST 2213 must be included in this degree program.

Area of Emphasis:

## LEGAL SECRETARY

(CIP 0507.060400)

General Education courses selected from those listed for the AS degree on page 58, plus from 38 to 46 semester hours of electives and specialization courses selected with the approval of a faculty advisor from those specified below.

Specialization Courses	Sem. Hrs.
OST 1355	Records Management .....3
OST 1601	Machine Transcription .....3
BUL 2241	Business Law I .....3
OST 2120	Advanced Typewriting .....2
PLA 1105	Legal Research .....3
OST 1212	Intermediate Shorthand .....3
OST 2213	Advanced Shorthand .....3
PLA 1104	Case Analysis and Legal Writing .....3
PLA 1763	Law Office Management .....3
MTB 1103	Business Math .....3
OST 1131	Legal Typewriting .....3
CGS 2571	Word Perfect I .....3
CGS 2572	Word Perfect II .....3
OST 1110*	Intermediate Typewriting .....2
CGS 2450	Microcomputing for Business .....3
CGS 2570	Introduction to Windows .....3
OST 1107	Document Processing I .....3
OST 2117	Document Processing II .....3
OST 2127	Document Processing III .....3
	Approved Technical Electives .....2

NOTE: (OST 1110, CGS 2571, and CGS 2572) OR (OST 1107, OST 2117, and OST 2127).

Area of Emphasis:

## MARKETING MANAGEMENT

(CIP 0206.140100)

General Education courses selected from those listed for the AS degree on page 58, plus from 38 to 46 semester hours of electives and specialization courses selected with the approval of a faculty advisor from those specified below.

Specialization Courses	Sem. Hrs.
MAR 2011	Marketing .....3
MKA 2021	Salesmanship .....3
MKA 2511	Advertising .....3
GEB 1011	Introduction to Business .....3
ACG 2001	Accounting I .....3
BUL 2241	Business Law I .....3
ACG 2011	Accounting II .....3
	or
BUL 2242	Business Law II .....3
MNA 2100	Human Relations .....3
MAN 2021	Management .....3
ECO 2013	Economics I .....3
CGS 1060	Computer Literacy .....3
MTB 1103	Business Math .....3
MKA 2041	Retail Management .....3
GEB 1940	Internship .....3
CGS 2450	Microcomputing for Business .....3
CGS 2570	Introduction to Windows .....3
	Business Elective .....3

**Area of Emphasis:**

**OFFICE MANAGEMENT TECHNOLOGY\***

(CIP 0507.040100)

General Education courses selected from those listed for the AS degree on page 58, plus from 38 to 46 semester hours of electives and specialization courses selected with the approval of a faculty advisor from those specified below.

Specialization Courses		Sem. Hrs.
OST 1211	Shorthand .....	3
OST 1212	Intermediate Shorthand .....	3
OST 2213	Advanced Shorthand .....	3
CGS 2571	WordPerfect I .....	3
CGS 2572	WordPerfect II .....	3
OST 2402	Secretarial Office Management .....	3
OST 1355	Records Management .....	3
OST 1110	Intermediate Typewriting .....	3
OST 2120	Advanced Typewriting .....	3
ACG 2001	Accounting I .....	3
OST 1601	Machine Transcription .....	3
BUL 2241	Business Law I .....	3
MAN 2021	Management .....	3
OST 2335	Business Communications .....	3
CGS 1060	Computer Literacy .....	3
MTB 1103	Business Math .....	3
GEB 1011	Introduction to Business .....	3
MAR 2011	Marketing .....	3
GRA 1541C	Introduction to Copy Preparation .....	4
GRA 1820C	Desktop Publishing I .....	3
GRA 1821C	Desktop Publishing II .....	3
GRA 2800C	Computer Graphics I .....	4
CGS 2450	Microcomputing for Business .....	3
CGS 2570	Introduction to Windows .....	3
OST 1107	Document Processing I .....	3
OST 2117	Document Processing II .....	3
OST 2127	Document Processing III .....	3

**NOTE:** (OST 1110, CGS 2571, and CGS 2572) OR (OST 1107, OST 2117, and OST 2127).

\*Students will be admitted to the levels of typewriting and shorthand for which they are qualified; OST 2120 and OST 2213 must be included in this degree program.

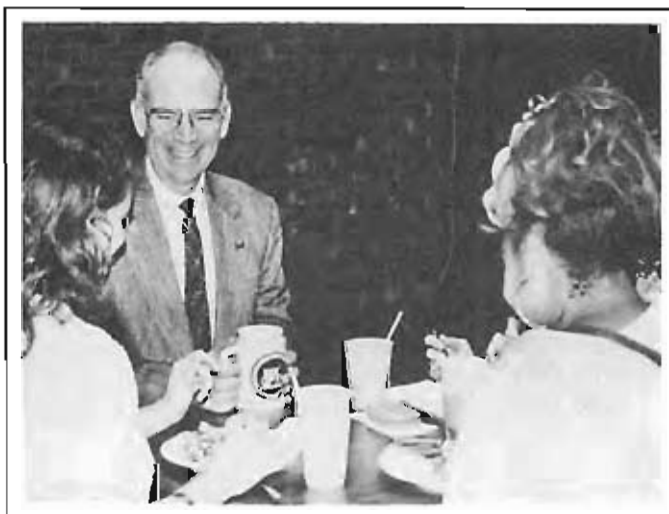

**Area of Emphasis:**

**REAL ESTATE MANAGEMENT**

(CIP 0206.179900)

General Education courses selected from those listed for the AS degree on page 58, plus from 38 to 46 semester hours of electives and specialization courses selected with the approval of a faculty advisor from those specified below.

Specialization Courses		Sem. Hrs.
MTB 1103	Business Math .....	3
ECO 2013	Economics I .....	3
ECO 2023	Economics II .....	3
GEB 1011	Introduction to Business .....	3
REE 1040A	Introduction to Real Estate .....	3
ACG 2001	Accounting I .....	3
ACG 2011	Accounting II .....	3
BUL 2241	Business Law I .....	3
BUL 2242	Business Law II .....	3
CGS 1060	Computer Literacy .....	3
OST 2335	Business Communications .....	3
MKA 2021	Salesmanship .....	3
MAR 2011	Marketing .....	3
MAN 2021	Management .....	3
CGS 2450	Microcomputing for Business .....	3
CGS 2570	Introduction to Windows .....	3

**Area of Emphasis:**

**RESTAURANT MANAGEMENT**

(CIP 0206.0970400)

General Education courses selected from those listed for the AS degree on page 58, plus from 38 to 46 semester hours of electives and specialization courses selected with the approval of a faculty advisor from those specified below.

Specialization Courses		Sem. Hrs.
FSS 1202C	Beginning Food Preparation I .....	6
FSS 1203C	Beginning Food Preparation II .....	6
FSS 1221	Quantity Food Preparation I .....	6
FSS 1222	Quantity Food Preparation II .....	6
HFT 2261	Restaurant Management I .....	6
HFT 2262	Restaurant Management II .....	6

**Electives**

FSS 1246C	Commercial Baking .....	6
CGS 1060	Computer Literacy .....	3

*OWCC President, Dr. James R. Richburg, visits with students in the College Mall.*



OWCC operates one of the few programs in Florida for issuing the Child Development Credential which certifies child care workers.

## HUMAN DEVELOPMENT

Area of Emphasis:

### CHILD DEVELOPMENT AND EDUCATION SERVICES

(CIP 0420.020502)

General Education courses selected from those listed for the AS degree on page 58, plus from 38 to 46 semester hours of electives and specialization courses selected with the approval of a faculty advisor from those specified below.

Specialization Courses	Sem. Hrs.
CHD 1220 Child Growth and Development I .....	3
CHD 1430 Observing and Recording Child Behavior .....	3
CHD 2322 Programs for Young Children .....	3
CHD 2432A Curriculum for Young Children I .....	3
HUN 2410A Child Nutrition and Health .....	3
or	
HUN 2001 Nutrition .....	3
CHD 1800 Early Childhood Program Administration .....	3
CHD 2433 Child Development Seminar .....	3
CHD 1941 Internship — Child Development .....	12
(May be repeated 4 times for 12 hours credit)	

**Recommended Electives:**

CHD1230 Child Growth and Development II .....	3
COA 2100 Consumer Education .....	3
FAD 1123 Adults in a Changing Society .....	3
HUS 1400 Peer Advising .....	3
HSC 1400 First Aid .....	3

## MANUFACTURING & TECHNOLOGY

Area of Emphasis:

### AIR CONDITIONING, HEATING, AND REFRIGERATION SYSTEMS TECHNOLOGY

(CIP 0615.050 100)

General Education courses selected from those listed for the AS degree on page 58, plus from 38 to 46 semester hours of electives and specialization courses selected with the approval of a faculty advisor from those specified below.

Specialization Courses (Min. 30 hrs.)	Sem. Hrs.
✓ ACR 1000 Principles of Air Conditioning, Heating and Refrigeration .....	6
ACR 2060 Air Conditioning, Heating and Refrigeration .....	6
✓ ACR 1100 Electrical Theory .....	6
ACR 2600 Principles of Gas, Electrical, and Solar Heating .....	6
✓ ACR 2303 Electrical Controls for Air Conditioning and Refrigeration .....	6
ACR 2745 Commercial Air Conditioning/ Refrigeration .....	6
<b>Electives</b>	
ETD 1111 Drafting I (HVAC) .....	6
STA 2014 Statistics .....	3
BCN 2610 Construction Estimating .....	3
ENC 2210 Technical Report Writing .....	3
EGS 1110C Engineering Graphics .....	3
ACR 2810 Environmental Control Systems .....	3

Area of Emphasis:

### AVIATION MAINTENANCE MANAGEMENT

(CIP 0649.010401)

General Education courses selected from those listed for the AS degree on page 58, plus from 38 to 46 semester hours of electives and specialization courses selected with the approval of a faculty advisor from those specified below.

Specialization Courses	Sem. Hrs.
AMT 1000 Aviation General .....	4
AMT 1140 Aircraft Welding .....	3
AMT 1811 Airframe Mechanics I .....	4
AMT 1812 Airframe Mechanics II .....	4
AMT 1821 Air Powerplant I .....	4
AMT 1822 Air Powerplant II .....	4
EET 1015C Basic Electricity/Electronics I .....	5
EET 1025C Basic Electricity/Electronics II .....	5
ETG 1941 Internship Technical Education .....	3
EGS 1110C Engineering Graphics .....	3



Area of Emphasis:

## BUILDING CONSTRUCTION TECHNOLOGY

(CIP 0615.100101)

General Education courses selected from those listed for the AS degree on page 58, plus from 38 to 46 semester hours of electives and specialization courses selected with the approval of a faculty advisor from those specified below.

Specialization Courses	Sem. Hrs.
BCN 1230 Building Construction: Materials and Processes .....	3
BCN 2610 Construction Estimating .....	3
BCN 1708 Construction Documentation .....	3
BCN 1520 Electrical Systems in Construction .....	3
BCN 1567 Plumbing and Gas Construction Practices .....	3
BCN 2475 Structural Systems in Construction .....	3
BCN 2560 Mechanical Systems in Construction .....	3
BCN 2721 Construction Management/Planning .....	3
EGS 1110C Engineering Graphics .....	3
TAR 2121C Architectural Drafting .....	3
REE 1040A Introduction to Real Estate .....	3

### Recommended Electives

BUL 2241 Business Law I .....	3
ETD 2542 Structural Drafting .....	3
CGS 1000 Introduction to Computer Programming .....	3
ETD 1311 Computer/Systems Drafting .....	3
BCN 1272 Blueprint Reading for Commercial Construction .....	3
SUR 2100C Surveying I .....	3
ETD 1310 Introduction to Computer Drafting .....	3

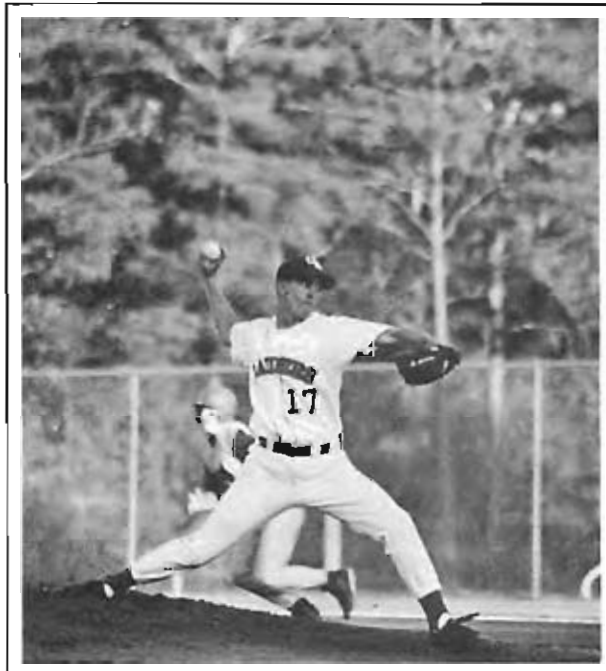

OWCC offers a range of both intercollegiate and intramural sports programs.

Area of Emphasis:

## DRAFTING AND DESIGN TECHNOLOGY (CAD/CAM)

(CIP 0615.020200)

General Education courses selected from those listed for the AS degree on page 58, plus from 38 to 46 semester hours of electives and specialization courses selected with the approval of a faculty advisor from those specified below.

Specialization Courses (38 hours required)  
Required Core Courses: 30 hours

Mechanical Track	Sem. Hrs.
ETD 1100 Introduction to Technical Drawing .....	3
ETD 1111 Drafting I .....	6
ETD 1221 Drafting II .....	6
ETD 1700 Drafting III .....	6
ETD 1310 Introduction to Computer Drafting .....	3
ETD 1311 Computer/Systems Drafting .....	3
ETD 2351 Advanced Computer System Drafting .....	3
ETD 1710 Basic Machine Drafting .....	3
ETD 2218 Geometric Dimensioning and Tolerancing .....	3
ETI 2110 Quality Control I .....	3

Electro/Mechanical Track	Sem. Hrs.
ETD 1100 Introduction to Technical Drawing .....	3
ETD 1111 Drafting I .....	6
ETD 1221 Drafting II .....	6
ETD 1700 Drafting III .....	6
ETD 1310 Introduction to Computer Drafting .....	3
ETD 1311 Computer/Systems Drafting .....	3
ETD 1710 Basic Machine Drafting .....	3
ETD 1654 Intermediate PCB Drafting .....	3
ETD 1614 Electromechanical Drafting .....	3
ETD 1653 Printed Circuit Board Drafting .....	3
ETD 2655 Adv. Printed Circuit Board Drafting .....	3
ETD 2218 Geometric Dimensioning and Tolerancing .....	3

Architectural Track	Sem. Hrs.
ETD 1100 Introduction to Technical Drawing .....	3
EGS 1110C Engineering Graphics .....	3
EGS 1130C Descriptive Geometry .....	3
ETD 1310 Introduction to Computer Drafting .....	3
ETD 1311 Computer/Systems Drafting .....	3
ETD 2351 Advanced Computer System Drafting .....	3
TAR 2121C Architectural Drafting .....	3
ETD 2542 Structural Drafting I .....	3
ETD 2543C Structural Drafting II .....	3
BCN 1272 Blueprint Reading for Commercial Construction .....	3
SUR 2100C Surveying I .....	3
BCN 2610 Construction Estimating .....	3
BCN 1230 Building Construction: Materials and Processes .....	3

(Continued on next page)

**DRAFTING AND DESIGN TECHNOLOGY (CAD/CAM)**  
(continued from page 63)

<b>Recommended Elective Courses:</b>		<b>Sem. Hrs.</b>
ETD 1801	Technical Illustration .....	3
ETD 1320	Introduction to 3D Modeling .....	3
ETD 2355	3D Modeling .....	3
ETD 2705	Advanced Mechanical Drafting .....	3
ETG 1941	Technical Internship .....	3
SUR 2140C	Surveying II .....	3
CGS 2560	MS/DOS/Micro Computers .....	1
CET 1251	Basic Computer Operations and Maintenance for Technology .....	3
ETI 2110	Quality Control I .....	3
ETD 2351	Advanced Computer Systems Drafting .....	3
ETD 1614	Electromechanical Drafting .....	3

**CAD/Computer Aided Manufacturing**

<b>Required Courses</b>		<b>Sem. Hrs.</b>
EGS 1110C	Engineering Graphics .....	3
EGS 1130C	Descriptive Geometry .....	3
ETD 1310	Introduction to Computer Drafting .....	3
ETD 1311	Computer/Systems Drafting .....	3
ETD 1320	Introduction to 3D Modeling .....	3
ETD 1710	Basic Machine Drafting .....	3
ETD 2218	Geometric Dimensioning and Tolerancing .....	3
ETI 2110	Quality Control I .....	3

**CAD/Computer-Aided Manufacturing**

<b>Electives</b>		<b>Sem. Hrs.</b>
ETD 2355	3D Modeling .....	3
ETD 2219	Advanced Geometric Dimensioning and Tolerancing .....	3
ETD 1653	Printed Circuit Board .....	3
ETD 1654	Intermediate Printed Circuit Board .....	3
ETD 2655	Advanced Printed Circuit Board .....	3
PMT 2405	Production Technology .....	3
ETI 1411	Advanced Manufacturing Processes .....	3
ETI 2111	Quality Control II .....	3
EET 1015C	Basic Electricity/Electronics I .....	5
EET 1025C	Electricity/Electronics II .....	5
EET 1141C	Devices and Circuits I .....	5
CET 2114C	Digital Fundamentals .....	5
EET 1606C	Soldering/PC Board Techniques .....	2

**Area of Emphasis:**

**ELECTRONICS DESIGN TECHNOLOGY\***

(CIP 0615.030301)

General Education courses selected from those listed for the AS degree on page 58, plus from 38 to 46 semester hours of electives and specialization courses selected with the approval of a faculty advisor from those specified below.

<b>Specialization Courses</b>		<b>Sem. Hrs.</b>
EET 1015C	Electricity/Electronics I .....	5
EET 1025C	Electricity/Electronics II .....	5
EET 1141C	Devices and Circuits I .....	5
EET 1142C	Devices and Circuits II .....	5
CET 2114C	Digital Fundamentals .....	5
CET 2123C	Microprocessor Fundamentals .....	5
ETD 1100	Introduction to Technical Drawing .....	3
ETD 1310	Introduction to Computer Drafting .....	3
ETD 1653	PCB Drafting .....	3
ETD 1654	Intermediate PCB Drafting .....	3

**Required General Education Elective:**

CGS 1060	Computer Literacy .....	3
----------	-------------------------	---

**Area of Emphasis:**

**ELECTRONICS ENGINEERING TECHNOLOGY\***

(CIP 0615.030301)

General Education courses selected from those listed for the AS degree on page 58, plus from 38 to 46 semester hours of electives and specialization courses selected with the approval of a faculty advisor from those specified below.

<b>Specialization Courses</b>		<b>Sem. Hrs.</b>
EET 1015C	Electricity/Electronics I .....	5
EET 1025C	Electricity/Electronics II .....	5
EET 1141C	Devices and Circuits I .....	5
EET 1142C	Devices and Circuits II .....	5
CET 1251	Basic Computer Operation and Maintenance for Technology .....	3
CET 2114C	Digital Fundamentals .....	5
CET 2123C	Microprocessor Fundamentals .....	5
EET 1606C	Soldering/PC Board Techniques .....	2

**Specialization: (Options)**

CET 2311C	Computer Assisted Circuit Analysis .....	4
CET 2152	Computer Analysis and Troubleshooting .....	5
EET 2322C	Electronic Communication .....	5
EET 2215C	Electronic Instrumentation .....	5

\*Student must select a total of 40 semester hours.

**Area of Emphasis:**

**GRAPHIC COMMUNICATIONS**

General Education courses selected from those listed for the AS degree on page 58, plus from 38 to 46 semester hours of electives and specialization courses selected with the approval of a faculty advisor from those specified below.

**Graphic Design Technology  
(CIP 0605.040200)**

<b>Specialization Courses</b>		<b>Sem. Hrs.</b>
ART 1300C	Drawing I .....	3
ART 1201C	Two Dimensional Design .....	3
ART 1480C	Computer Art .....	3
GRA 1541C	Introduction to Copy Preparation .....	4
GRA 1571C	Process Camera I .....	4
GRA 1573C	Process Camera II .....	4
GRA 1543C	Graphic/Commercial Design I .....	3
GRA 2544C	Graphic/Commercial Design II .....	3
GRA 2547C	Projects in Graphic Design .....	3
GRA 1530C	Typography .....	3
	Graphic Communications Electives .....	5
		38

**Graphic Arts Technology  
(CIP 0650.040201)**

GRA 1541C	Introduction to Copy Preparation .....	4
GRA 1571C	Process Camera I .....	4
GRA 1573C	Process Camera II .....	4
GRA 1601C	Fake Color Film Assembly .....	3
GRA 1636C	Small Offset Press Operations .....	4
GRA 1821C	Desktop Publishing II .....	3
GRA 2635C	Offset Presswork I .....	4
ART 1430C	Screen Printing I .....	3
GRA 1820C	Desktop Publishing I .....	3
	Graphic Communications Electives .....	6
		38

**Computer Graphic Technology  
(CIP 0650.040201)**

GRA 1541C	Introduction to Copy Preparation .....	4
GRA 1820C	Desktop Publishing I .....	3
GRA 1821C	Desktop Publishing II .....	3
GRA 2800C	Computer Graphics I .....	4
ART 1482C	Computer Art .....	3
ART 1201C	Design I .....	3
GRA 1571C	Process Camera I .....	4
GRA 1573C	Process Camera II .....	4
ART 1300C	Drawing I .....	3
GRA 1543C	Graphic/Comm. Design I .....	3
	Graphic Communications Electives .....	4
		38

**Graphic Communications Electives:**

CGS 1060	Computer Literacy .....	3
GRA 1530C	Typography .....	3
GRA 2905	Independent Study – Graphics .....	1
GRA 2949	Directed Work Study – Graphics .....	1
PGY 1101C	Photography .....	2
EGS 1110C	Engineering Graphics .....	3
ART 1430C	Screen Printing I .....	3
ART 1431C	Screen Printing II .....	3
MKA 2511	Introduction to Advertising .....	3
GRA 1820C	Desktop Publishing I .....	3
GRA 1821C	Desktop Publishing II .....	3
ART 1480C	Computer Art .....	3
ART 2955	Portfolio Development .....	3
GRA 2800C	Computer Graphics .....	4
ART 1301C	Drawing II .....	3
ART 1481C	Computer Graphics Design I .....	4

**Area of Emphasis:**

**MANUFACTURING TECHNOLOGY**

(CIP 0615.060302)

General Education courses selected from those listed for the AS degree on page 58, plus from 38 to 46 semester hours of electives and specialization courses selected with the approval of a faculty advisor from those specified below.

<b>Specialization Courses</b>		<b>Sem. Hrs.</b>
ETI 2110	Quality Control I .....	3
ETI 2111	Quality Control II .....	3
PMT 2405	Production Technology .....	3
ETI 1411	Advanced Manufacturing Processes .....	3
EGS 1110C	Engineering Graphics .....	3
ETD 1653	Printed Circuit Board Drafting .....	3
ETD 1654	Intermediate PCB Drafting .....	3
ETD 2655	Advanced Printed Circuit Board Drafting .....	3
EET 1015C	Basic Electricity/Electronics I .....	5
EET 1141C	Devices and Circuits I .....	5
ETD 2218	Geometric Dimensioning and Tolerancing .....	3
ETD 2219	Advanced Geometric Dimensioning and Tolerancing .....	3
ETD 1310	Introduction to Computer Drafting .....	3
	Approved Technical Electives .....	4



Area of Emphasis:

**CRIMINAL JUSTICE**

(CIP 0743.010300)

General Education courses selected from those listed for the AS degree on page 58, plus from 38 to 46 semester hours of electives and specialization courses selected with the approval of a faculty advisor from those specified below.

Required Core Courses: 18 Hours		Sem. Hrs.
CCJ 1020	Introduction to Criminal Justice .....	3
CCJ 1000	Introduction to Criminology .....	3
CCJ 1500	Juvenile Delinquency .....	3
CCJ 1935	Criminal Justice Seminar .....	3
CJD 1930	Human Diversity .....	3
CCJ 2300	Introduction to Corrections .....	3

Electives:		Sem. Hrs.
CJT 2140	Introduction to Criminalistics .....	3
CCJ 1121	Crime Prevention .....	3
CCJ 1192	Crisis Intervention .....	3
CCJ 1310	Discipline and Special Confinement .....	3
CCJ 1400	Police Organization & Administration .....	3
CCJ 1611	Child Abuse .....	3
CCJ 1650	Introduction to Narcotics Investigation .....	3
CCJ 1941	Internship – Criminal Justice .....	3
CCJ 2070	Computer Applications in Criminal Justice .....	3
CCJ 2330	Introduction to Probation & Parole .....	3
CJD 2310	Criminal Justice Supervision .....	5
CJD 2320	Criminal Justice Management .....	5
CJD 2470	Emergency Preparedness .....	3
CJD 2605	Traffic Homicide .....	3

**NOTE:** Other Public Safety Courses will apply. Students should see an advisor to select the proper elective courses and to develop a plan for completing the degree total of 64 semester hours.

Area of Emphasis:

**PARALEGAL/LEGAL ASSISTANT**

(CIP 0722.010300)

General Education courses selected from those listed for the AS degree on page 58, plus from 38 to 46 semester hours of electives and specialization courses selected with the approval of a faculty advisor from those specified below.

Required Core Courses: 18 Hours		Sem. Hrs.
PLA 1003	Introduction to Paralegalism .....	3
PLA 1105	Legal Research .....	3
PLA 2263	Rules of Evidence .....	3
PLA 1763	Law Office Management .....	3
PLA 1203	Introduction to Civil Law .....	3
PLA 1013	Introduction to Legal System .....	3
PLA 1104	Case Analysis & Legal Writing .....	3

Electives:

CCJ 1210	Criminal Law .....	3
CCJ 1230	Criminal Procedures .....	3
PLA 1051	Legal Terminology .....	3
PLA 1460	Bankruptcy Law .....	3
PLA 1603	Wills, Trusts, Probate .....	3
PLA 1804	Introduction to Family Law .....	3
PLA 1803	Family Law II .....	3
PLA 2273	Torts: Injury .....	3
PLA 2483	Administrative Law .....	3
PLA 2930	Insurance Law .....	3
PLA 2949	Paralegal Internship .....	3

Area of Emphasis:

**PUBLIC SERVICE TECHNOLOGY**

(CIP 0743.020100)

General Education courses selected from those listed for the AS degree on page 58, plus from 38 to 46 semester hours of electives and specialization courses selected with the approval of a faculty advisor from those specified below.

Students pursuing a degree in Public Service cannot matriculate in any one specific area of study for more than eighteen (18) semester hours without counselor approval.

Specialization Courses		Sem. Hrs.
FFP 1000	Introduction to Fire Science .....	3
FFP 1100	Fire Protection, Organization and Administration .....	3
FFP 2300	Fire Codes and Building Construction .....	3
FFP 2200	Fundamentals of Fire Prevention .....	3
FFP 2410	Fire Fighting Tactics and Strategy I .....	3
FFP 2420	Fire Fighting Tactics and Strategy II .....	3
FFP 2620	Automatic Alarm and Extinguishing Systems .....	3
FFP 2600	Fire Apparatus .....	3
FFP 2240	Arson Detection and Investigation .....	3
FFP 2500	Explosives and Hazardous Material .....	3
EMT 2159C	Emergency Medical Technology I .....	8
CCJ 1020	Introduction to Criminal Justice .....	3
CJT 2340	Police Operations .....	3
CJD 1460	Correctional Operations .....	3
CCJ 2300	Introduction to Corrections .....	3

Other courses as authorized by the public safety division may apply.

# ASSOCIATE OF SCIENCE DEGREE APPLIED SCIENCE OPTIONS PROGRAM REQUIREMENTS

Associate of Science Degree, Applied Science Options, are provided for skill training in industrial technical, business, and child care. Additional training is provided each student in mid-management areas to better prepare for advancement or a supervisory position

**Course in Residence.** (Credit hours taken at Okaloosa-Walton Community College). Minimum requirement of courses taken in residence for Applied Science Options at Okaloosa-Walton Community College is normally 15-semester hours of credit. SIXTY-FOUR (64) HOURS ARE REQUIRED FOR GRADUATION, and students may earn AS/ASO degrees in multiple programs at OWCC.

**General Education.** The general education requirements for students selecting Applied Science Options with the Associate of Science degree at Okaloosa-Walton Community College may be reduced to a minimum of 16-semester hours of required general education credit to be selected from four of the five following areas, subject to approval of the department chairman.

**Area of Emphasis.** In addition to the required 16 semester hours of General Education, each student must complete an additional 48 to 56 semester hours in a specialization as listed in this section. Students should consult their designated faculty advisor to select the appropriate courses in the specialized field that will fulfill the degree requirements.

**Occupational Certificates.** Students may earn a certificate (local technical award) upon completion of 30 to 36 semester hours of skill training in the AS/ASO program areas. See the section on Occupational Certificates for specific course requirements.

## NOTE — NOTE — NOTE — NOTE — NOTE — NOTE — NOTE — NOTE

Florida Administrative Code Rules require that all students receiving an Associate of Science Degree who plan to transfer to a state university shall take and pass the College Level Academic Skills Test according to the schedule as listed in the calendar of instructional activities in this catalog.

## GENERAL EDUCATION REQUIREMENTS (16 Semester Hour Minimum)

Sem. Hrs.	Course Selections
Communications Skills .....3	ENC 1101, 1102, LIN 1670
Mathematics .....3	MAT 1033, MAC 1102, STA 2014, MTB 1103, MGF 2202, MTB 1321, 1322
Science .....4	CHM 1020, PHY 1020, GLY 1001, PHY 1053C, 1054C, BSC 1005, GLY 1010C
Social Science .....3	AMH 2010, 2020, AMH 1041, WOH 1012, 1022, WOH 2040, POT 1002, POS 1041, INR 2002, PSY 2012, SYG 2000, SYG 2010, GEO 1000, ANT 2000, ANT 2100
Humanities .....3	HUM 1020, ARH 1000, MUH 1011, AML 2000, AML 2022, ENL 2011, ENL 2012, ARH 2050, 2051, PHI 2010, PHI 2600, REL 2300, LIT 2090, LIT 2100, THE 2000, THE 2071

**Specialization.** To complete requirements for graduation, each student must have earned at least 64 semester hours of credit with a minimum of 16 in the general education sequence and an approximate total of 48 in a specialization. Other general education courses listed for the AA degree may be taken to satisfy the above requirements.

The student is to plan a specialized program in consultation with a departmental advisor.

Self-contained curricula are offered by the departments for students seeking to prepare themselves for entry-level positions in a career field upon completion of the degree.

Students desiring to complete an Applied Science Option may, in consultation with a faculty advisor, select one of the following specializations:

## OCCUPATIONAL ELECTIVES ASSOCIATE OF SCIENCE DEGREE and APPLIED SCIENCE OPTIONS PROGRAMS IN MANUFACTURING/TECHNOLOGY AND PUBLIC SAFETY DEPARTMENTS

**Occupational Electives.** The courses listed below would be common to any of the AS Applied Science Options Programs as occupational electives:

ACG 2001	Accounting I	HSC 1400	First Aid
BUL 2241	Business Law I	MKA 2021	Salesmanship
COA 2100	Consumer Education	MKA 2511	Introduction to Advertising
EGS 1110C	Engineering Graphics	MTB 1103	Business Math
ENC 2210	Technical Report Writing	GEB 1011	Introduction to Business
OST 1100	Typewriting I	MAN 2021	Management
OST 2335	Business Communications	MNA 2100	Human Relations
FAD 1123	Adults in a Changing Society	STA 2014	Statistics

Other courses by programs which might serve as occupational electives for the following are:

**Air Conditioning:** Beginning course(s) in Drafting, Welding, and Electronics Technology.

**Restaurant Management:** MAN 2021-Management, GEB 1011-Introduction to Business, FSS 1246C-Commercial Banking, and HSC 1400-First Aid.

**Drafting and Design:** COP 2200-FORTRAN Programming, EGS 1130C-Descriptive Geometry, EET 1015C-Electronics I, EET 1025C-Electronics 2, and ETI 2110-Quality Control I.

**Electronics:** COP 2200-FORTRAN Programming, ETI 2110-Quality Control and ETD 1111-Drafting I.

Other courses may be approved upon written recommendation to the Vice President for Instruction by the department advisor.

---

*New inductees to the Sigma Mu chapter of Phi Theta Kappa, the national honor society for community college students. Phi Theta Kappa members must maintain a 3.5 grade point average on 12 or more credit hours while working toward an Associate of Arts degree.*



Area of Emphasis:

**ACCOUNTING TECHNOLOGY**

(CIP 0507.010100)

General Education courses selected from those listed for the AS/ASO degree on page 67, plus from 48 to 56 semester hours of electives and specialization courses selected with the approval of a faculty advisor from those specified below.

Specialization Courses		Sem. Hrs.
CGS 1060	Computer Literacy .....	3
	or	
CIS 1000	DP Concepts .....	3
MTB 1103	Business Math .....	3
ECO 2013	Economics I .....	3
ECO 2023	Economics II .....	3
ACG 2001	Accounting I .....	3
ACG 2011	Accounting II .....	3
ACG 2071	Managerial Accounting .....	3
BUL 2241	Business Law I .....	3
BUL 2242	Business Law II .....	3
GEB 1011	Intro. to Business .....	3
CGS 2560	MS-DOS .....	1
CGS 2510	Intro. to Spreadsheets .....	2
OST 2335	Business Communications .....	3
MAN 2021	Management .....	3
TAX 2000	Federal Income Tax: Ind. ....	3
MAC 2233	Calculus for Business .....	3
CGS 2450	Microcomputing for Business .....	3
CGS 2570	Introduction to Windows .....	3
	Approved Electives .....	6

Area of Emphasis:

**BUSINESS ADMINISTRATION AND MANAGEMENT**

(CIP 0506.049901)

General Education courses selected from those listed for the AS/ASO degree on page 67, plus from 48 to 56 semester hours of electives and specialization courses selected with the approval of a faculty advisor from those specified below.

Specialization Courses		Sem. Hrs.
GEB 1011	Introduction to Business .....	3
BUL 2241	Business Law I .....	3
MNA 2100	Human Relations .....	3
CGS 1060	Computer Literacy .....	3
MAR 2011	Introduction to Marketing .....	3
ACG 2001	Accounting I .....	3
ACG 2011	Accounting II .....	3
BUL 2242	Business Law II .....	3
OST 2335	Business Communications .....	3
MAN 2021	Management .....	3
ECO 2013	Economics I .....	3
MTB 1103	Business Math .....	3
MAN 2300	Personnel Management .....	3
CGS 2450	Microcomputing for Business .....	3
CGS 2570	Introduction to Windows .....	3
	Business Electives .....	9

Area of Emphasis:

**BUSINESS ADMINISTRATION AND MANAGEMENT (BANKING OPTION)**

(CIP 0506.049901)

General Education courses selected from those listed for the AS/ASO degree on page 67, plus from 48 to 56 semester hours of electives and specialization courses selected with the approval of a faculty advisor from those specified below.

OWCC Course	AIB Course	Title	Sem. Hrs.
ACG 2001	1000	Accounting I .....	3
BAN 2500	2310	Economics for Bankers .....	3
BAN 2800	3660	Law and Banking .....	3
BAN 2511	7740	Marketing for Bankers .....	3
BAN 2501	1350	Money and Banking .....	3
BAN 1004	1370	Principles of Banking .....	3
BAN 1231	6350	Commercial Lending .....	3
BAN 2210	6920	Analyzing Financial Statements .....	3
BAN 1240	7008	Consumer Lending .....	3
CGS 2450		Microcomputing for Business .....	3
CGS 2570		Introduction to Windows .....	3
BAN 2531	4265	Introduction to Supervision .....	1

**ELECTIVE SPECIALIZATION COURSES**

Remaining specialization courses are selected from the approved list .....14

Area of Emphasis:

**COMPUTER PROGRAMMING AND ANALYSIS**

(CIP 0507.030500)

General Education courses selected from those listed for the AS/ASO degree on page 67, plus from 48 to 56 semester hours of electives and specialization courses selected with the approval of a faculty advisor from those specified below.

Specialization Courses		Sem. Hrs.
GEB 1011	Introduction to Business .....	3
ACG 2001	Accounting I .....	3
ACG 2011	Accounting II .....	3
CIS 1000	Data Processing Concepts .....	3
COP 2120	COBOL Programming .....	3
COP 2200	FORTRAN Programming .....	3
BUL 2241	Business Law I .....	3
MNA 2100	Human Relations .....	3
MAN 2021	Management .....	3
ECO 2013	Economics I .....	3
MAC 1140	Pre-Calculus Algebra .....	3
COP 2000	Programming I .....	3
COP 2001	Programming II .....	3
MTB 1103	Business Math .....	3
CGS 2450	Microcomputing for Business .....	3
CGS 2750	Introduction to Windows .....	3
	Approved Electives .....	6

Area of Emphasis:

## HUMAN RESOURCES MANAGEMENT

(CIP 0506.049901)

General Education courses selected from those listed for the AS/ASO degree on page 67, plus from 48 to 56 semester hours of electives and specialization courses selected with the approval of a faculty advisor from those specified below.

Specialization Courses	Sem. Hrs.
ACG 2022	Managerial Accounting .....3
CGS 1060	Computer Literacy .....3
MTB 1103	Business Math .....3
MAN 2300	Personnel Management .....3
ECO 2013	Economics I .....3
ECO 2023	Economics II .....3
ACG 2001	Accounting I .....3
ACG 2011	Accounting II .....3
BUL 2241	Business Law I .....3
BUL 2242	Business Law II .....3
MNA 2100	Human Relations .....3
OST 2335	Business Communications .....3
GEB 1011	Intro. to Business .....3
MAN 2021	Management .....3
GEB 1940	Internship .....3
CGS 2450	Microcomputing for Business .....3
CGS 2570	Introduction to Windows .....3
	Business Electives .....9

Area of Emphasis:

## INDUSTRIAL MANAGEMENT TECHNOLOGY

(CIP 0606.200101)

General Education courses selected from those listed for the AS/ASO degree on page 67, plus from 48 to 56 semester hours of electives and specialization courses selected with the approval of a faculty advisor from those specified below.

Specialization Courses	Sem. Hrs.
MNA 1015	Industrial Management I .....3
MNA 2301	Industrial Management II .....3
MAN 1345	Supervision I .....3
MNA 1346	Supervision II .....3
MTB 1103	Business Math .....3
MAR 2011	Marketing .....3
OST 2335	Business Communications .....3
MNA 2100	Human Relations .....3
MAN 2300	Personnel Management .....3
CGS 1060	Computer Literacy .....3
ACG 2001	Accounting I .....3
GEB 1940	Internship .....3
CGS 2450	Microcomputing for Business .....3
CGS 2570	Introduction to Windows .....3

Area of Emphasis:

## LEGAL SECRETARY

(CIP 0507.060401)

General Education courses selected from those listed for the AS/ASO degree on page 67, plus from 48 to 56 semester hours of electives and specialization courses selected with the approval of a faculty advisor from those specified below.

Specialization Courses	Sem. Hrs.
OST 1110	Intermediate Typewriting .....2
OST 2120	Advanced Typewriting .....2
OST 1355	Records Management .....3
ACG 2001	Accounting I .....3
OST 1601	Machine Transcription .....3
BUL 2241	Business Law I .....3
PLA 1105	Legal Research .....3
MNA 2100	Human Relations .....3
OST 1212	Intermediate Shorthand .....3
OST 2213	Advanced Shorthand .....3
PLA 1104	Case Analysis and Legal Writing .....3
PLA 1763	Law Office Management .....3
MTB 1103	Business Math .....3
OST 1131	Legal Typewriting .....3
CGS 2571	Word Perfect I .....3
CGS 2572	Word Perfect II .....3
	Business Electives .....2
CGS 2450	Microcomputing for Business .....3
CGS 2570	Introduction to Windows .....3
OST 1107	Document Processing I .....3
OST 2117	Document Processing II .....3
OST 2127	Document Processing III .....3

**NOTE:** (OST 1110, CGS 2571, and CGS 2572) OR (OST 1107, OST 2117, and OST 2127)

Area of Emphasis:

## MARKETING MANAGEMENT

(CIP 0206.140100)

General Education courses selected from those listed for the AS/ASO degree on page 67, plus from 48 to 56 semester hours of electives and specialization courses selected with the approval of a faculty advisor from those specified below.

Specialization Courses	Sem. Hrs.
GEB 1011	Introduction to Business .....3
ACG 2001	Accounting I .....3
BUL 2241	Business Law I .....3
MKA 2021	Salesmanship .....3
MKA 2511	Advertising .....3
ACG 2011	Accounting II .....3
BUL 2242	Business Law II .....3
MAR 2011	Introduction to Marketing .....3
MNA 2100	Human Relations .....3
MAN 2021	Management .....3
ECO 2013	Economics I .....3
CGS 1060	Computer Literacy .....3
MTB 1103	Business Math .....3
MAN 2300	Personnel Management .....3
CGS 2450	Microcomputing for Business .....3
CGS 2570	Introduction to Windows .....3
	Business Electives .....9



**Area of Emphasis:**

**OFFICE SYSTEMS TECHNOLOGY**

(CIP 0507.060300)

General Education courses selected from those listed for the AS/ASO degree on page 67, plus from 48 to 56 semester hours of electives and specialization courses selected with the approval of a faculty advisor from those specified below.

Specialization Courses	Sem. Hrs.
OST 1211	Shorthand .....3
MTB 1103	Business Math .....3
GEB 1011	Introduction to Business .....3
OST 1601	Machine Transcription .....3
BUL 2241	Business Law I .....3
OST 2335	Business Communications .....3
MNA 2100	Human Relations .....3
CGS 1060	Computer Literacy .....3
OST 2402	Secretarial Office Management .....3
OST 1110	Intermediate Typewriting .....2
OST 2120	Advanced Typewriting .....2
OST 1355	Records Management .....3
OST 1212	Intermediate Shorthand .....3
OST 2213	Advanced Shorthand .....3
ACG 2001	Accounting I .....3
CGS 2571	Word Perfect I .....3
CGS 2572	Word Perfect II .....3
MAR 2011	Marketing .....3
GRA 1541C	Introduction to Copy Preparation .....4
GRA 1820C	Desktop Publishing I .....3
GRA 1821C	Desktop Publishing II .....3
GRA 2800C	Computer Graphics .....4
CGS 2450	Microcomputing for Business .....3
CGS 2570	Introduction to Windows .....3
OST 1107	Document Processing I .....3
OST 2117	Document Processing II .....3
OST 2127	Document Processing III .....3

**NOTE:** (OST 1110, CGS 2571, and CGS 2572) OR (OST 1107, OST 2117, and OST 2127)

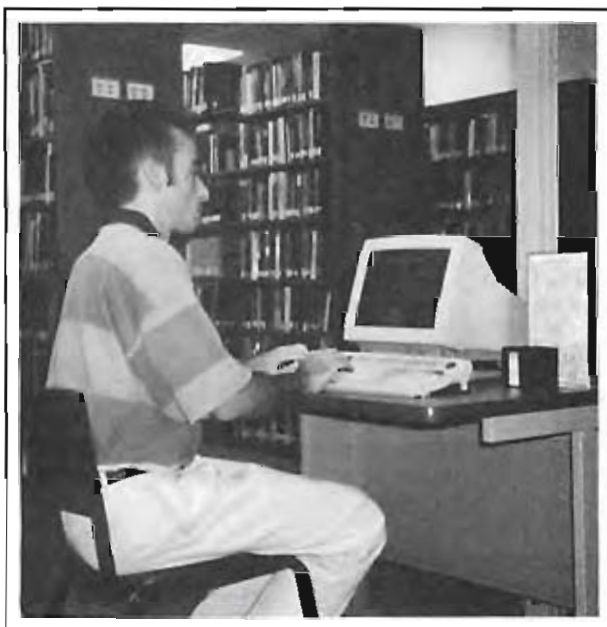

**Area of Emphasis:**

**REAL ESTATE MANAGEMENT**

(CIP 0206.179900)

General Education courses selected from those listed for the AS/ASO degree on page 67, plus from 48 to 56 semester hours of electives and specialization courses selected with the approval of a faculty advisor from those specified below.

Specialization Courses (select 48 hours)	Sem. Hrs.
MTB 1103	Business Math .....3
GEB 1011	Introduction to Business .....3
REE 1040A	Intro. to Real Estate Course I .....4
ACG 2001	Accounting I .....3
ACG 2011	Accounting II .....3
BUL 2241	Business Law I .....3
BUL 2242	Business Law II .....3
OST 2335	Business Communications .....3
MKA 2021	Salesmanship .....3
MNA 2100	Human Relations .....3
ECO 2013	Economics I .....3
ECO 2023	Economics II .....3
CGS 1060	Computer Literacy .....3
MAR 2011	Intro. to Marketing .....3
MKA 2511	Intro. to Advertising .....3
MAN 2021	Management .....3
CGS 2450	Microcomputing for Computers .....3
CGS 2570	Introduction to Windows .....3

**Area of Emphasis:**

**RESTAURANT MANAGEMENT**

(CIP 0206.070400)

General Education courses selected from those listed for the AS/ASO degree on page 67, plus from 48 to 56 semester hours of electives and specialization courses selected with the approval of a faculty advisor from those specified below.

Specialization Courses	Sem. Hrs.
FSS 1202C	Beginning Food Preparation I .....6
FSS 1203C	Beginning Food Preparation II .....6
FSS 1221	Quantity Food Preparation I .....6
FSS 1222	Quantity Food Preparation II .....6
HFT 2261	Restaurant Management I .....6
HFT 2262	Restaurant Management II .....6
	Approved Occupational Electives .....12

*The Learning Resources Center on the Niceville campus boasts one of the most sophisticated library computer networks in the state. The system gives students access to the library holdings of all 9 state universities and 28 community colleges, plus access to numerous CD-ROM databases and worldwide information sources through Internet.*

Area of Emphasis:

## WORD PROCESSING TECHNOLOGY

(CIP 0507.060801)

General Education courses selected from those listed for the AS/ASO degree on page 67, plus from 48 to 56 semester hours of electives and specialization courses selected with the approval of a faculty advisor from those specified below.

Specialization Courses		Sem. Hrs.
OST 1110	Intermediate Typing	2
OST 1351	Filing	3
MTB 1103	Business Mathematics	3
GEB 1011	Introduction to Business	3
ACG 2001	Accounting I	3
OST 2120	Advanced Typing	2
BUL 2241	Business Law I	3
BUL 2242	Business Law II	3
OST 2335	Business Communications	3
OST 2401	General Office Practice	3
MAN 2100	Human Relations	3
MAN 2021	Management	3
OST 1601	Machine Transcription	3
CGS 1060	Computer Literacy	3
CGS 2571	Word Perfect I	3
CGS 2572	Word Perfect II	3
	Business Elective	6
CGS 2450	Microcomputing for Business	3
CGS 2570	Introduction to Windows	3
OST 1107	Document Processing I	3
OST 2117	Document Processing II	3
OST 2127	Document Processing III	3

**NOTE:** (OST 1110, CGS 2571, and CGS 2572) OR (OST 1107, OST 2117, and OST 2127)

## HUMAN DEVELOPMENT

Area of Emphasis:

### CHILD DEVELOPMENT AND EDUCATION SERVICES

(CIP 0420.020502)

General Education courses selected from those listed for the AS/ASO degree on page 67, plus from 48 to 56 semester hours of electives and specialization courses selected with the approval of a faculty advisor from those specified below.

Specialization Courses		Sem. Hrs.
CHD 1220	Child Growth and Development	3
CHD 1430	Observing and Recording Child Behavior	3
HUN 2410A	Child Nutrition and Health	3
	or	
HUN 2001	Nutrition	3
CHD 2322	Programs for Young Children	3
CHD 2432A	Curriculum for Young Children I	3

CHD 1800	Early Childhood Program Administration	3
CHD 2433	Child Development Seminar	3
CHD 1941	Internship — Child Development (May be repeated 4 times for 12 hours credit)	12

#### Recommended Electives

HSC 1400	First Aid	3
CHD 1230	Child Growth and Development II	3
HUS 1400	Peer Advising	3
MUH 1011	Music for General Education	3
FAD 1123	Adults in a Changing Society	3
CHD 2130	Orientation to CDA Credential	3
EMS 1065C	Cardiopulmonary Resuscitation	1

## MANUFACTURING & TECHNOLOGY

Area of Emphasis:

### AIR CONDITIONING, HEATING, AND REFRIGERATION SYSTEMS TECHNOLOGY

(CIP 0615.080100)

General Education courses selected from those listed for the AS/ASO degree on page 67, plus from 48 to 56 semester hours of electives and specialization courses selected with the approval of a faculty advisor from those specified below.

Specialization Courses		Sem. Hrs.
ACR 1300	Electrical Theory	6
ACR 1000	Principles of Air Conditioning, Heating and Refrigeration	6
ACR 2600	Principles of Gas, Electrical, and Solar Heating	6
ACR 2060	Air Conditioning, Heating, and Refrigeration	6
ACR 2303	Electrical Controls for Air Conditioning and Refrigeration	6
ACR 2745	Commercial Air Conditioning and Refrigeration	6
	Approved Occupational Electives	12

Area of Emphasis:

### AUTOMOTIVE SERVICE TECHNOLOGY\*

(CIP 0615.080300)

General Education courses selected from those listed for the AS/ASO degree on page 67, plus from 48 to 56 semester hours of electives and specialization courses selected with the approval of a faculty advisor from those specified below.

\*This program is offered in cooperation with Okaloosa Public Schools.

**Area of Emphasis:**

**AVIATION MAINTENANCE MANAGEMENT**

(CIP 0647.060203)

General Education courses selected from those listed for the AS/ASO degree on page 67, plus from 48 to 56 semester hours of electives and specialization courses selected with the approval of a faculty advisor from those specified below.

Specialization Courses		Sem. Hrs.
AMT 1000	Aviation General .....	4
AMT 1140	Aircraft Welding .....	3
AMT 1811	Airframe Mechanics I .....	4
AMT 1812	Airframe Mechanics II .....	4
AMT 1821	Air Powerplant I .....	4
AMT 1822	Air Powerplant II .....	4
EET 1015C	Basic Electricity/Electronics I .....	5
EET 1025C	Basic Electricity/Electronics II .....	5
EET 1141C	Devices and Circuits I .....	5

**Occupational Electives**

MNA 1345	Industrial Supervision I .....	3
MNA 1346	Industrial Supervision II .....	3
MNA 1015	Industrial Management I .....	3
MNA 2301	Industrial Management II .....	3
EGS 1110C	Engineering Graphics .....	3

**Area of Emphasis:**

**DRAFTING AND DESIGN TECHNOLOGY (CAD/CAM)**

(CIP 0615.020200)

General Education courses selected from those listed for the AS/ASO degree on page 67, plus from 48 to 56 semester hours of electives and specialization courses selected with the approval of a faculty advisor from those specified below.

**Specialization Courses (48 hours required)**

**Required Core Courses: 38 hours**

Mechanical Track		Sem. Hrs.
ETD 1100	Introduction to Technical Drawing .....	3
ETD 1111	Drafting I .....	6
ETD 1221	Drafting II .....	6
ETD 1700	Drafting III .....	6
ETD 1310	Introduction to Computer Drafting .....	3
ETD 1311	Computer/Systems Drafting .....	3
ETD 1710	Basic Machine Drafting .....	3
ETD 2218	Geometric Dimensioning and Tolerancing .....	3
ETD 2219	Advanced Geometric Dimensioning and Tolerancing .....	3

Electro/Mechanical Track		Sem. Hrs.
ETD 1100	Introduction to Technical Drawing .....	3
ETD 1111	Drafting I .....	6
ETD 1221	Drafting II .....	6
ETD 1700	Drafting III .....	6
ETD 1310	Introduction to Computer Drafting .....	3
ETD 1311	Computer/Systems Drafting .....	3
ETD 1710	Basic Machine Drafting .....	3
ETD 1654	Intermediate PCB Drafting .....	3
ETD 1614	Electromechanical Drafting .....	3
ETD 1653	Printed Circuit Board Drafting .....	3
ETD 2655	Adv. Printed Circuit Board Drafting .....	3
ETD 2218	Geometric Dimensioning and Tolerancing .....	3

Architectural Track		Sem. Hrs.
ETD 1100	Introduction to Technical Drawing .....	3
EGS 1110C	Engineering Graphics .....	3
EGS 1130C	Descriptive Geometry .....	3
ETD 1310	Introduction to Computer Drafting .....	3
ETD 1311	Computer/Systems Drafting .....	3
ETD 2351	Advanced Computer System Drafting .....	3
TAR 2121C	Architectural Drafting .....	3
ETD 2542	Structural Drafting I .....	3
ETD 2543C	Structural Drafting II .....	3
BCN 1272	Blueprint Reading for Commercial Construction .....	3
SUR 2100C	Surveying I .....	3
BCN 2610	Construction Estimating .....	3
BCN 1230	Building Construction: Materials and Processes .....	3

Recommended Elective Courses:		Sem. Hrs.
ETD 1801	Technical Illustration .....	3
ETD 1320	Introduction to 3D Modeling .....	3
ETD 2355	3D Modeling .....	3
ETD 2705	Advanced Mechanical Drafting .....	3
ETG 1941	Technical Internship .....	3
SUR 2140C	Surveying II .....	3
CGS 2560	MS/DOS/Micro Computers .....	1
CET 1251	Basic Computer Operations and Maintenance for Technology .....	3
ETD 2351	Advanced Computer Systems Drafting .....	3
ETI 2110	Quality Control I .....	3
ETD 1614	Electromechanical Drafting .....	3

CAD/Computer Aided Manufacturing Required Courses		Sem. Hrs.
EGS 1110C	Engineering Graphics .....	3
EGS 1130C	Descriptive Geometry .....	3
ETD 1310	Introduction to Computer Drafting .....	3
ETD 1311	Computer/Systems Drafting .....	3
ETD 1320	Introduction to 3D Modeling .....	3
ETD 1710	Basic Machine Drafting .....	3
ETD 2218	Geometric Dimensioning and Tolerancing .....	3
ETI 2110	Quality Control I .....	3

(Continued on next page)

**DRAFTING AND DESIGN TECHNOLOGY (CAD/CAM)**  
(continued from page 73)

**CAD/Computer-Aided Manufacturing**

Electives		Sem. Hrs.
ETD 2355	3D Modeling .....	3
ETD 2219	Advanced Geometric Dimensioning and Tolerancing .....	3
ETD 1653	Printed Circuit Board .....	3
ETD 1654	Intermediate Printed Circuit Board .....	3
ETD 2655	Advanced Printed Circuit Board .....	3
PMT 2405	Production Technology .....	3
ETI 1411	Advanced Manufacturing Processes .....	3
ETI 2111	Quality Control II .....	3
EET 1015C	Basic Electricity/Electronics I .....	5
EET 1025C	Electricity/Electronics II .....	5
EET 1141C	Devices and Circuits I .....	5
CET 2114C	Digital Fundamentals .....	5
EET 1606C	Soldering/PC Board Techniques .....	2

**Area of Emphasis:**

**ELECTRONICS DESIGN TECHNOLOGY**

(CIP 0618.010400)

General Education courses selected from those listed for the AS/ASO degree on page 67, plus from 48 to 56 semester hours of electives and specialization courses selected with the approval of a faculty advisor from those specified below.

Specialization Courses		Sem. Hrs.
EET 1015C	Electricity/Electronics I .....	5
EET 1025C	Electricity/Electronics II .....	5
EET 1141C	Devices and Circuits I .....	5
EET 1142C	Devices and Circuits II .....	5
CET 2114C	Digital Fundamentals .....	5
CET 2123C	Microprocessors Fundamentals .....	5
ETD 1100	Introduction to Technical Drawing .....	3
ETD 1310	Introduction to Computer Drafting .....	3
ETD 1654	PCF Drafting .....	3
ETD 1654	Intermediate PCB Drafting .....	3
EET 2322C	Electronic Communication .....	5
CET 2152C	Computer Analysis & Troubleshooting .....	5

**Required General Education Elective:**

CGS 1060	Computer Literacy .....	3
----------	-------------------------	---

**Area of Emphasis:**

**ELECTRONICS ENGINEERING TECHNOLOGY**

(CIP 0615.030301)

General Education courses selected from those listed for the AS/ASO degree on page 67, plus from 48 to 56 semester hours of electives and specialization courses selected with the approval of a faculty advisor from those specified below.

Specialization: Core		Sem. Hrs.
EET 1015C	Electricity/Electronics I .....	5
EET 1025C	Electricity/Electronics II .....	5
EET 1141C	Devices and Circuits I .....	5
EET 1142C	Devices and Circuits II .....	5
CET 2114C	Digital Fundamentals .....	5
CET 2123C	Microprocessor Fundamentals .....	5
EET 1606C	Soldering/PC Board Techniques .....	2
CET 1251	Basic Computer Operation and Maintenance for Technology .....	3

**Specialization: Options (Students chooses three)**

EET 2322C	Electronics Communications .....	5
CET 2152C	Computer Analysis and Troubleshooting .....	5
CET 2311C	Computer Assisted Circuit Analysis .....	4
EET 2215C	Electronics Instrumentation .....	5

**Area of Emphasis:**

**GRAPHIC COMMUNICATIONS**

General Education courses selected from those listed for the AS/ASO degree on page 67, plus from 48 to 56 semester hours of electives and specialization courses selected with the approval of a faculty advisor from those specified below.

**Graphic Design Technology**  
(CIP 0605.040200)

Specialization Courses		Sem. Hrs.
ART 1300C	Drawing I .....	3
ART 1201C	Two Dimensional Design .....	3
ART 1480C	Computer Art .....	3
GRA 1541C	Introduction to Copy Preparation .....	4
GRA 1571C	Process Camera I .....	4
GRA 1573C	Process Camera II .....	4
GRA 1543C	Graphic/Commercial Design I .....	3
GRA 2544C	Graphic/Commercial Design II .....	3
GRA 2547C	Projects In Graphic Design .....	3
PGY 1101C	Photography .....	3
GRA 1530C	Typography .....	3
Graphic Communications Electives .....		12

**Graphic Arts Technology**  
(CIP 0650.080100)

GRA 1820C	Desktop Publishing .....	3
GRA 1541C	Introduction to Copy Preparation .....	4
GRA 1821C	Desktop Publishing II .....	3
GRA 1571C	Process Camera I .....	4
GRA 1573C	Process Camera II .....	4
GRA 1601C	Fake Color Film Assembly .....	3
GRA 1636C	Small Offset Press .....	4
GRA 2635C	Offset Presswork I .....	4
ART 1430C	Screen Printing I .....	3
ART 1431C	Screen Printing II .....	3
PGY 1101C	Photography .....	2
	Graphic Communications Electives .....	11

**Computer Graphics Technology**  
(CIP 0650.080100)

GRA 1541C	Introduction to Copy Preparation .....	4
GRA 1820C	Desktop Publishing I .....	3
GRA 1821C	Desktop Publishing II .....	3
GRA 2800C	Computer Graphics I .....	4
ART 1480C	Computer Art .....	3
ART 1201C	Two Dimensional Design .....	3
GRA 1571C	Process Camera I .....	4
GRA 1573C	Process Camera II .....	4
ART 1300C	Drawing I .....	3
GRA 1543C	Graphic/Commercial Design I .....	3
ART 1430C	Screen Printing I .....	3
GRA 1636C	Small Offset Press .....	4
GRA 1601C	Fake Color Assembly .....	3
	Graphic Communications Electives .....	4
		48

**Graphic Communications Electives:**

CGS 1060	Computer Literacy .....	3
GRA 1530C	Typography .....	3
GRA 2905	Independent Study – Graphics .....	1
GRA 2949	Directed Work Study – Graphics .....	1
PGY 1101C	Photography .....	2
EGS 1110C	Engineering Graphics .....	3
ART 1430C	Screen Printing I .....	3
ART 1431C	Screen Printing II .....	3
MKA 2511	Introduction to Advertising .....	3
GRA 1820C	Desktop Publishing I .....	3
GRA 1821C	Desktop Publishing II .....	3
ART 1480C	Computer Art .....	3
ART 2955	Portfolio Development .....	3

**Area of Emphasis:**

**MANUFACTURING TECHNOLOGY**  
(CIP 0615.060400)

General Education courses selected from those listed for the AS/ASO degree on page 67, plus from 48 to 56 semester hours of electives and specialization courses selected with the approval of a faculty advisor from those specified below.

Specialization Courses		Sem. Hrs.
ETI 2110	Quality Control I .....	3
ETI 2111	Quality Control II .....	3
PMT 2405	Production Technology .....	3
ETI 1411	Advanced Manufacturing Processes .....	3
EGS 1110C	Engineering Graphics .....	3
ETD 1653	Printed Circuit Board Drafting .....	3
ETD 2655	Advanced Printed Circuit Board Drafting .....	3
EET 1015C	Basic Electricity/Electronics I .....	5
EET 1141C	Devices and Circuits I .....	5
ETD 2218	Geometric Dimensioning and Tolerancing .....	3
ETD 2219	Advanced Geometric Dimensioning and Tolerancing .....	3
ETD 1310	Introduction to Computer Drafting .....	3
ETD 1654	Intermediate PCB Drafting .....	3
	Approved Technical Electives .....	8

**Area of Emphasis:**

**WELDING TECHNOLOGY**  
(CIP 0615.061000)

General Education courses selected from those listed for the AS/ASO degree on page 67, plus from 48 to 56 semester hours of electives and specialization courses selected with the approval of a faculty advisor from those specified below.

This program is offered in cooperation with the Okaloosa Public Schools.



*The OWCC dance team "Raider Rhythms" perform during half-time at a basketball game.*



Area of Emphasis:

**CRIMINAL JUSTICE TECHNOLOGY  
CRIMINAL JUSTICE STANDARDS  
ACADEMY**

(CIP 0743.010300)

General Education courses selected from those listed for the AS/ASO degree on page 67, plus from 48 to 56 semester hours of electives and specialization courses selected with the approval of a faculty advisor from those specified below.

Required Core Courses: 43 Hours		Sem. Hrs.
CJD 1700	Criminal Justice Legal I .....	3
CJD 1701	Criminal Justice Legal II .....	3
CJD 2720	Law Enforcement Legal III .....	3
CJD 1702	Criminal Justice Communications .....	3
CJD 1703	Criminal Justice Interpersonal Skills I .....	3
CJD 1740	Corrections Interpersonal Skills II .....	3
CJD 1722	Law Enforcement Traffic .....	3
CJD 1721	Law Enforcement Patrol .....	3
CJD 1724	Law Enforcement Investigation .....	4
CJD 2254	Criminal Justice Medical .....	3
CJD 1705	Criminal Justice Weapons .....	2
CJD 1704	Criminal Justice Defensive Tactics .....	4
CJD 1723	Law Enforcement Vehicle Operations .....	3
CJD 1741	Corrections Emergency Preparedness .....	2
CJD 1742	Corrections Operations .....	4

**ELECTIVES:** As approved by a Public Safety Advisor.

**NOTE:** Entry into Criminal Justice Technology Program requires meeting the standards as established by the Criminal Justice Advisory Board and the Florida Department of Law Enforcement, Division of Criminal Justice Standards and Training for employment. A copy of these requirements will be furnished by the Public Safety Division of OWCC.

In addition, students must comply with Rule 6A-10.040 of the Department of Education. A copy of this rule will be furnished by the Public Safety Division of OWCC.



*Many OW students balance school with jobs. This student concentrates on coursework before returning to her military duties.*

*Intercollegiate sports at OWCC include women's and men's basketball, men's baseball and women's fast-pitch softball. ▼*





# OCCUPATIONAL CERTIFICATES (Local Technical Awards)

Certificates (local technical awards) are issued for completion of skill training (30 to 36 semester hours) in an AS/ASO Degree Program. The following areas of emphasis represent the degree programs in which the local awards may be earned.

Admission requirements are the same as for the AS degree, Applied Science Options.

Each graduate must be in attendance at OWCC during his/her last term. A grade-point average of not less than "C" must be obtained on the accumulative total of all courses required for a specific occupational certificate. The minimum grade-point average for all required occupational certificate course work attempted at OWCC must be 2.0 ("C").

Students must make formal application for certificates on the proper form furnished by the Registrar.

Students desiring information or wishing to enter one of the certificate programs are to see the department chair of the department which has the program or see a faculty advisor in that department.

Students in Drafting and Electronics are required to take entry level mathematics ASSET test and to take College Prep Algebra if they do not make a passing score. MTB 1321 Technical Mathematics I is also required for students in these programs.

Appropriate course substitutions may be authorized by the Vice President for Instruction, upon written recommendation by the department chair.

\* NOTE: These programs are NOT approved for veterans training. There are local incentive awards given for completion of a specified portion of an Associate of Science Degree.



## BUSINESS

### ACCOUNTING TECHNOLOGY

Course	Course Title	Sem. Hrs.
CGS 1060	Computer Literacy .....	3
MTB 1103	Business Math .....	3
ECO 2013	Economics I .....	3
ACG 2001	Accounting I .....	3
ACG 2011	Accounting II .....	3
ACG 2071	Managerial Accounting .....	3
BUL 2241	Business Law I .....	3
GEB 1011	Intro. to Business .....	3
CGS 2510	Introduction to Spreadsheets .....	2
CGS 2560	MS-DOS .....	1
OST 2335	Business Communications .....	3
MAN 2021	Management .....	3
TAX 2000	Federal Income Tax: Ind. ....	3
CGS 2450	Microcomputing for Business .....	3
CGS 2570	Introduction to Windows .....	3

### BUSINESS ADMINISTRATION AND MANAGEMENT

Course	Course Title	Sem. Hrs.
GEB 1011	Introduction to Business .....	3
BUL 2241	Business Law I .....	3
MNA 2100	Human Relations .....	3
CGS 1060	Computer Literacy .....	3
MAR 2011	Introduction to Marketing .....	3
ACG 2001	Accounting I .....	3
ACG 2011	Accounting II .....	3
BUL 2242	Business Law II .....	3
OST 2335	Business Communications .....	3
MAN 2021	Management .....	3
ECO 2013	Economics I .....	3
MTB 1103	Business Math .....	3
MAN 2300	Personnel Management .....	3
CGS 2450	Microcomputing for Business .....	3
CGS 2570	Introduction to Windows .....	3
	Approved Business Elective .....	3

## BUSINESS ADMINISTRATION AND MANAGEMENT (BANKING OPTION)

### Required Specialization Courses

OWCC Course	AIB Course	Title	Sem. Hrs
ACG 2001	1000	Accounting I	3
BAN 2500	2310	Economics for Bankers	3
BAN 2800	3660	Law and Banking	3
BAN 2511	7740	Marketing for Bankers	3
BAN 2501	1350	Money and Banking	3
BAN 1004	1370	Principles of Banking	3
BAN 1231	6350	Commercial Lending	3
BAN 2210	6920	Analyzing Financial Statements	3
BAN 1240	7008	Consumer Lending	3
CGS 2450		Microcomputing for Business	3
CGS 2570		Introduction to Windows	3
BAN 2531	4265	Introduction to Supervision	1

### ELECTIVE SPECIALIZATION COURSES

Remaining specialization courses are selected from the approved list .....4

## HUMAN RESOURCES MANAGEMENT

Course	Course Title	Sem. Hrs.
CGS 1060	Computer Literacy	3
MTB 1103	Business Math	3
MAN 2300	Personnel Management	3
ECO 2013	Economics I	3
ACG 2001	Accounting I	3
ACG 2011	Accounting II	3
BUL 2241	Business Law I	3
BUL 2242	Business Law II	3
MNA 2100	Human Relations	3
OST 2335	Business Communications	3
GEB 1011	Intro. to Business	3
MAN 2021	Management	3
CGS 2450	Microcomputing for Business	3
CGS 2570	Introduction to Windows	3
	Approved Business Elective	3

## INDUSTRIAL MANAGEMENT TECHNOLOGY

Course	Course Title	Sem. Hrs.
MNA 1015	Industrial Management I	3
MNA 2301	Industrial Management II	3
MNA 1345	Supervision I	3
MNA 1346	Supervision II	3
ACG 2001	Accounting I	3
MAR 2011	Marketing	3
OST 2335	Business Communications	3
MNA 2100	Human Relations	3
MTB 1103	Business Math	3
CGS 1060	Computer Literacy	3
CGS 2450	Microcomputing for Business	3
CGS 2570	Introduction to Windows	3
	Approved Business Electives	6

## LEGAL SECRETARY

Course	Course Title	Sem. Hrs.
OST 1355	Records Management	3
OST 1601	Machine Transcription	3
BUL 2241	Business Law I	3
CGS 2571	Word Perfect I	3
CGS 2572	Word Perfect II	3
PLA 1105	Legal Research	3
MNA 2100	Human Relations	3
OST 1212	Intermediate Shorthand	3
OST 2213	Advanced Shorthand	3
PLA 1104	Case Analysis and Legal Writing	3
PLA 1763	Law Office Management	3
MTB 1103	Business Math	3
OST 1131	Legal Typewriting	3
OST 1110	Intermediate Typewriting	2
OST 2120	Advanced Typewriting	2
CGS 2450	Microcomputing for Business	3
CGS 2570	Introduction to Windows	3
OST 1107	Document Processing I	3
OST 2117	Document Processing II	3
OST 2127	Document Processing III	3

## MARKETING MANAGEMENT

Course	Course Title	Sem. Hrs.
GEB 1011	Introduction to Business	3
ACG 2001	Accounting I	3
BUL 2241	Business Law I	3
MKA 2021	Salesmanship	3
MKA 2511	Advertising	3
ACG 2011	Accounting II	3
MAR 2011	Introduction to Marketing	3
MNA 2100	Human Relations	3
MAN 2021	Management	3
CGS 1060	Computer Literacy	3
MTB 1103	Business Math	3
CGS 2450	Microcomputing for Business	3
CGS 2570	Introduction to Windows	3
	Approved Business Elective	3



## OFFICE SYSTEMS TECHNOLOGY

Maximum of 40 hours. See an advisor.

Course	Course Title	Sem. Hrs.
OST 1110	Intermediate Typewriting .....	2
OST 2120	Advanced Typewriting .....	2
OST 1211	Shorthand .....	3
OST 1212	Intermediate Shorthand .....	3
OST 2213	Advanced Shorthand .....	3
OST 1355	Records Management .....	3
CGS 2571	Word Perfect I .....	3
CGS 2572	Word Perfect II .....	3
OST 2402	Secretarial Office Management .....	3
MTB 1103	Business Math .....	3
OST 1601	Machine Transcription .....	3
OST 2335	Business Communication .....	3
ACG 2001	Accounting I .....	3
CGS 1060	Computer Literacy .....	3
GRA 1541C	Introduction to Copy Preparation .....	4
GRA 1820C	Desktop Publishing I .....	3
GRA 1821C	Desktop Publishing II .....	3
MAR 2011	Marketing .....	3
GEB 1011	Introduction to Business .....	3
CGS 2450	Microcomputing for Business .....	3
CGS 2570	Introduction to Windows .....	3
OST 1107	Document Processing I .....	3
OST 2117	Document Processing II .....	3
OST 2127	Document Processing III .....	3

## REAL ESTATE MANAGEMENT

Course	Course Title	Sem. Hrs.
MTB 1103	Business Math .....	3
REE 1200	Real Estate Finance .....	3
REE 1040A	Introduction to Real Estate: Course I .....	4
ACG 2001	Accounting I .....	3
ACG 2011	Accounting II .....	3
BUL 2241	Business Law .....	3
OST 2335	Business Communications .....	3
MKA 2021	Salesmanship .....	3
MNA 2100	Human Relations .....	3
MAN 2021	Management .....	3
MAR 2011	Marketing .....	3
CGS 2450	Microcomputing for Business .....	3
CGS 2570	Introduction to Windows .....	3
	Business Education Elective .....	3

## RESTAURANT MANAGEMENT

Course	Course Title	Sem. Hrs.
FSS 1202C	Beginning Food Preparation I .....	6
FSS 1203C	Beginning Food Preparation II .....	6
FSS 1221	Quantity Food Preparation I .....	6
FSS 1222	Quantity Food Preparation II .....	6
HFT 2261	Restaurant Management I .....	6
HFT 2262	Restaurant Management II .....	6
	Approved Occupational Electives .....	12

## WORD PROCESSING TECHNOLOGY

OST 1100	Beginning Typing .....	2
OST 1110	Intermediate Typing .....	2
OST 1355	Records Management .....	3
MTB 1103	Business Mathematics .....	3
ACG 2001	Accounting I .....	3
OST 2120	Advanced Typing .....	2
OST 2335	Business Communications .....	3
MAN 2021	Management .....	3
OST 1601	Machine Transcription .....	3
CGS 1060	Computer Literacy .....	3
OST 2401	General Office Practice .....	3
CGS 2571	Word Perfect I .....	3
CGS 2572	Word Perfect II .....	3
CGS 2450	Microcomputing for Business .....	3
CGS 2570	Introduction to Windows .....	3
OST 1107	Document Processing I .....	3
OST 2117	Document Processing II .....	3
OST 2127	Document Processing III .....	3



## HUMAN DEVELOPMENT

### CHILD DEVELOPMENT AND EDUCATION SERVICES

Course	Course Title	Sem. Hrs.
CHD 1220	Child Growth and Development I .....	3
CHD 1430	Observing and Recording Child Behavior .....	3
CHD 2432A	Curriculum for Young Children I .....	3
HUN 2410A	Child Nutrition and Health .....	3
	or	
HUN 2001	Nutrition .....	3
FAD 1123	Adults in a Changing Society .....	3
HUS 1400	Peer Advising .....	3
COA 2100	Consumer Education .....	3
CHD 1941	Internship — Child Development .....	3
	(May be repeated 3 times for 9 credit hours)	
CHD 2433	Child Development Seminar .....	3
CHD 1230	Child Growth and Development II .....	3
CHD 2322	Programs for Young Children .....	3

## AIR CONDITIONING, HEATING, AND REFRIGERATION SYSTEMS TECHNOLOGY

Course	Course Title	Sem. Hrs.
ACR 1100	Electrical Theory .....	6
ACR 1000	Principles of Air Conditioning, Heating, and Refrigeration .....	6
ACR 2600	Principles of Gas, Electrical, and Solar Heating .....	6
ACR 2060	Air Conditioning, Heating and Refrigeration .....	6
ACR 2303	Electrical Controls for Air Conditioning and Refrigeration .....	6
ACR 2745	Commercial Air Conditioning and Refrigeration .....	6

## DRAFTING AND DESIGN TECHNOLOGY (CAD/CAM)

**Specialization Courses (36 hours required)**  
**Required Core Courses: 30 hours**

Mechanical Track		Sem. Hrs.
ETD 1100	Introduction to Technical Drawing .....	3
ETD 1111	Drafting I .....	6
ETD 1221	Drafting II .....	6
ETD 1700	Drafting III .....	6
ETD 1310	Introduction to Computer Drafting .....	3
ETD 1311	Computer/Systems Drafting .....	3
ETD 2351	Advanced Computer System Drafting .....	3
ETD 1710	Basic Machine Drafting .....	3
ETD 2218	Geometric Dimensioning and Tolerancing .....	3
ETI 2110	Quality Control I .....	3

Electro/Mechanical Track		Sem. Hrs.
ETD 1100	Introduction to Technical Drawing .....	3
ETD 1111	Drafting I .....	6
ETD 1221	Drafting II .....	6
ETD 1700	Drafting III .....	6
ETD 1310	Introduction to Computer Drafting .....	3
ETD 1311	Computer/Systems Drafting .....	3
ETD 1653	Printed Circuit Board Drafting .....	3
ETD 1710	Basic Machine Drafting .....	3
ETD 2655	Adv. Printed Circuit Board Drafting .....	3
ETD 2218	Geometric Dimensioning and Tolerancing .....	3

Architectural Track		Sem. Hrs.
ETD 1100	Introduction to Technical Drawing .....	3
EGS 1110C	Engineering Graphics .....	3
EGS 1130C	Descriptive Geometry .....	3
ETD 1310	Introduction to Computer Drafting .....	3
ETD 1311	Computer/Systems Drafting .....	3
ETD 2351	Advanced Computer System Drafting .....	3
TAR 2121C	Architectural Drafting .....	3
ETD 2542	Structural Drafting I .....	3
ETD 2543C	Structural Drafting II .....	3
BCN 1272	Blueprint Reading for Commercial Construction .....	3
SUR 2140C	Surveying I .....	3
BCN 2610	Construction Estimating .....	3
BCN 1230	Building Construction: Materials and Processes .....	3

Recommended Elective Courses:		Sem. Hrs.
ETD 1801	Technical Illustration .....	3
ETD 1320	Introduction to 3D Modeling .....	3
ETD 2355	3D Modeling .....	3
ETD 2705	Advanced Mechanical Drafting .....	3
ETG 1941	Technical Internship .....	3
SUR 2140C	Surveying II .....	3
CGS 2560	MS/DOS/Micro Computers .....	1
CET 1251	Basic Computer Operations and Maintenance for Technology .....	3
ETD 1614	Electromechanical Drafting .....	3
ETD 2351	Advanced Computer Systems Drafting ...	3

## ELECTRONICS ENGINEERING TECHNOLOGY

Core:		Sem. Hrs.
MTB 1321	Technical Math I .....	3
EET 1015C	Electricity/Electronics I .....	5
EET 1025C	Electricity/Electronics II .....	5
EET 1141C	Devices and Circuits I .....	5
EET 1142C	Devices and Circuits II .....	5
CET 2114C	Digital Fundamentals .....	5
EET 1606C	Soldering/PC Board Techniques .....	2
CET 1251	Basic Computer Operation and Maintenance for Technology .....	3

Specialization: Options (one required)		Sem. Hrs.
EET 2322C	Electronics Communications .....	5
CET 2123C	Microprocessor Fundamentals .....	5
CET 2152C	Computer Analysis and Troubleshooting .....	5
EET 2115C	Electronics Instrumentation .....	5

38 credit hours required

# GRAPHIC COMMUNICATIONS

## Graphic Design Technology

ART 1300C	Drawing I	3
ART 1201C	Two-Dimensional Design	3
GRA 1541C	Introduction to Copy Preparation	4
GRA 1571C	Process Camera I	4
GRA 1573C	Process Camera II	4
GRA 1543C	Graphic/Commercial Design I	3
GRA 2544C	Graphic/Commercial Design II	3
GRA 2547C	Projects in Graphic Design	3
GRA 1530C	Typography	3
ART 1480C	Computer Art	3
GRA 1820C	Desktop Publishing I	3
		<hr/>
		36

## Graphic Arts Technology

GRA 1820C	Desktop Publishing I	3
GRA 1821C	Desktop Publishing II	3
GRA 1541C	Introduction to Copy Preparation	4
GRA 1571C	Process Camera I	4
GRA 1573C	Process Camera II	4
GRA 1601C	Fake Color Film Assembly	3
GRA 1636C	Small Offset Press	4
GRA 2635C	Offset Presswork I	4
ART 1430C	Screen Printing I	3
		<hr/>
		32

# COMPUTER GRAPHICS TECHNOLOGY

Course	Course Title	Sem. Hrs.
GRA 1541C	Introduction to Copy Preparation	4
GRA 1820C	Desktop Publishing I	3
GRA 1821C	Desktop Publishing II	3
GRA 2800C	Computer Graphics I	4
ART 1480C	Computer Art	3
ART 1201C	Two-Dimensional Design	3
GRA 1571C	Process Camera I	4
GRA 1573C	Process Camera II	4
ART 1300C	Drawing I	3
GRA 1543C	Graphic/Commercial Design I	3
		<hr/>
		34

# MANUFACTURING TECHNOLOGY

ETI 2110	Quality Control I	3
ETI 2111	Quality Control II	3
PMT 2405	Production Technology	3
ETI 1411	Advanced Manufacturing Processes	2
EGS 1110C	Engineering Graphics	3
ETD 1653	Printed Circuit Board Drafting	3
ETD 2655	Advanced Printed Circuit Board Drafting	3
EET 1015C	Basic Electricity/Electronics I	5
EET 1141C	Devices and Circuits I	5
ETD 2218	Geometric Dimensioning and Tolerancing	3
ETD 2219	Advanced Geometric Dimensioning and Tolerancing	3
ETD 1310	Introduction to Computer Drafting	3
ETD 1654	Intermediate PCB Drafting	3

# PUBLIC SAFETY

## Law Enforcement Basic

CJD 1700	Criminal Justice Legal I	3
CJD 1701	Criminal Justice Legal II	3
CJD 2720	Law Enforcement Legal III	4
CJD 1702	Criminal Justice Communications	3
CJD 1703	Interpersonal Skills I	3
CJD 1704	Criminal Justice Defensive Tactics	4
CJD 1705	Criminal Justice Weapons	2
CJD 2254	Criminal Justice Medical	3
CJD 1721	Law Enforcement Patrol	4
CJD 1722	Law Enforcement Traffic	3
CJD 1723	Vehicle Operations	2
CJD 1724	Law Enforcement Investigations	4

## Corrections Basic

CJD 1700	Criminal Justice Legal I	3
CJD 1701	Criminal Justice Legal II	3
CJD 1702	Criminal Justice Communications	3
CJD 1703	Interpersonal Skills I	3
CJD 1704	Criminal Justice Defensive Tactics	4
CJD 1705	Criminal Justice Weapons	2
CJD 2254	Criminal Justice Medical	3
CJD 1740	Interpersonal Skills II	3
CJD 1741	Emergency Preparedness	2
CJD 1742	Correctional Operations	4

**NOTE:** Entry into Criminal Justice Certificate Programs requires meeting the standards as established by the Criminal Justice Advisory Board and the Florida Department of Law Enforcement, Division of Criminal Justice Standards and Training for employment. A copy of these requirements will be furnished by the Public Safety Division of OWCC.

In addition, students must comply with Rule 6A-10.040 of the Department of Education. A copy of this rule will be furnished by the Public Safety Division of OWCC.

# CONTINUING EDUCATION

The Continuing Education Division can organize and present short courses, long courses, workshops, seminars, meetings, and conferences. Such activities can take place in community based facilities, or OWCC facilities. We can use OWCC instructors, or employ qualified outside personnel. The college's principal vehicles for delivering continuing education are **Supplemental Education**, **Recreation and Leisure**, and **Non-Credit** activities.

## **SUPPLEMENTAL EDUCATION (Professional/Technical Development)**

This option is used when updating job-related knowledge and skills is the goal. Courses, workshops, and seminars can be developed to meet the specific needs of a given organization or company. Supplemental courses, workshops, or seminars can be as long or as short as necessary to meet the need. They can be scheduled for days, nights, and/or weekends and housed in any suitable facility.

## **RECREATION & LEISURE (Personal Development)**

This option is used to provide for enrichment needs that do not relate directly to job skills or knowledge. A wide range of avocational and personal, public, and community interest oriented activities can be presented under this category in the form of courses, workshops, and/or seminars. Educational programs can be as long or as short as necessary to meet the need. They can be scheduled for days, nights, or weekends and housed in any suitable facility available.

## **NONCREDIT COURSES**

Noncredit courses are planned continuing education experiences under the direction and instruction of the department in which they are offered. These courses may not be used toward any college degree.



*The Northwest Florida Symphony Orchestra makes its home at OWCC and performs several classical and popular music concerts annually throughout the region. The orchestra is comprised of OW students, faculty, and community members.*

# ADULT EDUCATION

## ADULT BASIC EDUCATION

Adult Basic Education at OWCC consists of individualized and small group instruction leading to a mastery of the basic skills needed by adults to function in today's complex society. Persons completing this program normally take the General Education Development (GED) Test. (See Fee Schedule, page 13, for costs).

## GENERAL EDUCATION DEVELOPMENT (GED)

### Adult Basic Education

Adult Basic Education consists of instruction leading to a mastery of basic and functional skills with curriculum addressing elementary through secondary grade levels. Persons completing this program normally take the General Education Development (GED) Test. Persons passing the GED test are awarded a high school diploma by the State of Florida.

### Purpose:

1. To provide academic guidance and counseling including student assessment of basic skills, GED practice examination, referral and placement services.
2. To provide support services; to include assistance and referral to other available community resources.
3. To provide basic skill instruction in reading, writing, mathematics and everyday survival skills.
4. To provide instruction in preparation for the GED examination leading to a Florida High School Diploma.

### Eligible Applicants:

1. Adults — age 16 years older, who are no longer in public schools.
2. Adults who need to pass the GED examination.
3. Adults with English as a second language.
4. Adults with a high school diploma who have reading, writing and mathematics skills below the secondary level.

### Contact Person:

Barbara M. Jones, Director, Adult Basic Education/Literacy Center, (904) 729-5387 or (904) 892-8100.

## VOCATIONAL PREPARATORY

Vocational Preparatory course work is offered for the specific purpose of preparing individuals for successful completion of vocational/occupational programs and for advancement or upgrading in their occupations. Students pursuing occupational program objectives should seek counselor/advisor assistance with regard to placement in Vocational Preparatory courses.

## COLLEGE PREPARATORY

College Preparatory courses are provided for high school graduates who are identified as needing additional academic preparation in computation and communications before pursuit of degree-credit college courses. These courses provide competency based instruction for the development of the prerequisite skills in reading, writing, mathematical reasoning and logical thinking for effective pursuit of **degree-credit** college courses.

Students whose entry level test scores are **below** the levels specified in State Board rules for taking college level courses in English and mathematics are required to enroll in the appropriate college prep courses before attempting college transfer work in those subjects. During their first term, full-time students who apply to enter degree programs and have registered for 12 or more credits, or part-time students who have accumulated at least 12 credits, shall begin prep instruction based on the placement scores.

Students enrolled in college prep courses may, also, take courses at the same time in other curriculum areas where qualified. (See "Entry-Level Testing" under the Admissions section of the catalog for further information.) The following college prep courses are offered each term:

- ENC 0010 **College Prep English – Level I**  
3 cr/45 class hours
- ENC 0020 **College Prep English – Level II**  
3 cr/45 class hours
- MAT 0024 **College Prep Algebra**  
3 cr/75 class hours
- REA 0001 **College Prep Reading**  
3 cr/75 class hours

Completing a college prep course satisfactorily will meet the requirement for moving forward into the corresponding college level course.

Students whose entry test scores are **above** the minimum level may take a college prep course if such enrollment would enhance their opportunities for future academic success. Students are reminded that college prep courses earn "S" and "U" grades, and credits earned in these courses do not count toward degree totals. Also, certain financial aid categories (including VA) will require justification for taking a college prep course if entry scores are above the cutoff level -- the college prep teacher will assist with any required documentation which the Registrar and/or Financial Aid offices may request.

By State Board rule, students may not enroll for more than three semesters in each skill area to complete college prep instruction. Students who withdraw officially before the midpoint of a semester may be considered to have **not** enrolled that semester for purposes of this limitation. Students who withdraw officially at or after the midpoint of a semester shall be considered to have enrolled that semester unless the withdrawal can be documented as due to reasons of personal hardship or disability or under major extenuating circumstances. Requests for waiver of the three-term limit should be submitted to the Vice President for Instruction for review and approval.



*Homecoming King and Queen Paul Knight and Kelly-Ann Morrissey take to the floor for a spotlight dance after being crowned. Homecoming festivities are held each year at OWCC during basketball season and are sponsored by the Student Government Association.*

## FLORIDA'S STATEWIDE COURSE NUMBERING SYSTEM

The course numbers appearing in the catalog are part of a statewide system of prefixes and numbers developed for use by all public postsecondary and participating private institutions in Florida. One of the major purposes of this system is to make transferring easier by identifying courses which are equivalent, no matter where they are taught in the state. All courses designated as equivalent will carry the same prefix and last three digits.

The classifying and numbering of courses is done by faculty in each academic discipline. Their work was reviewed by faculty members in all Florida's postsecondary institutions who make suggestions and criticisms to be incorporated into the system.

The course numbering system is, by law, descriptive and not prescriptive. It in no way limits or controls what courses may be offered or how they are taught. It does not affect course titles or descriptions at individual schools. It seeks only to describe what is being offered in postsecondary education in Florida in a manner that is intelligible and

useful to students, faculty, and other interested users of the system.

The course numbering system was developed so that equivalent courses could be accepted for transfer without misunderstanding. Each public institution is to accept for transfer credit any course which carries the same prefix and last three digits as a course at the receiving institution. For example, if a student has taken SYG-010 at a community college, he/she cannot be required to repeat SYG-010 at a community college to which he/she transfers. Further, credit for any course or its equivalent, as judged by the appropriate faculty task force and published in the course numbering system, which can be used by a native student to satisfy degree requirements at a public institution, can also be used for that purpose by a transfer student regardless of where the credit was earned.

It should be noted that a receiving institution is not precluded from using **nonequivalent** courses for satisfying certain requirements.

## GENERAL RULE FOR COURSE EQUIVALENCIES

All undergraduate courses bearing the same alpha prefix and last three numbers (and alpha suffix, if present) have been agreed upon by a faculty committee to be equivalent. For example, an introductory course in sociology is offered in over 36 postsecondary institutions in Florida. Since these courses are considered to be equivalent, each will carry the designator SYG-000.

## FIRST DIGIT

The first digit of the course number is assigned by the institution, generally to indicate the year it is offered; i.e., "1" indicates freshman year, "2" indicates sophomore year. In the sociology example mentioned above, one school which offers the course in the freshman year will number it SYG-1000; a school offering the same course in the sophomore year will number it SYG-2000. The variance in the first numbers does not affect the equivalency. If the prefix and last three digits are the same, the courses are substantively equivalent.

## TITLES

Each institution will retain its own title for each of its courses. The sociology courses mentioned are titled at different schools as "Introductory Sociology," "General Sociology," and "Principles of Sociology." The title does **not** affect the equivalency. The courses will carry the same prefix and last three digits; that is what identifies them as equivalent.

## LAB INDICATORS

Some courses will carry an alpha suffix indicating a lab. The alpha suffixes "L" and "C" are used as follows to indicate laboratories:

"L" means either (a) the content of a course is entirely laboratory or (b) the laboratory component of a lecture-lab sequence in which the lab is offered at a different time/place from the lecture.

"C" means a combined lecture-lab course in which the lab is offered in conjunction with the lecture at the same time/same place.

Examples.

Marine Biology OCB-013 (lecture only)

OCB-013L (lab only)

Marine Biology OCB-013C (lecture & lab combined) with lab

Therefore, OCB-013C is equivalent to OCB-013 plus OCB-013L.

## EQUIVALENCY OF SEQUENCES

In certain cases, sequences of courses in a given discipline are equivalent rather than the individual courses which make up these sequences. (For example, CHM-045 plus CHM-046). In several institutions, however, upon completion of the full sequence at any of the several institutions, students have completed substantively equivalent content. These sequences are clearly identified in the Course Equivalency Profiles.

## EXPLANATION OF PREFIXES AND NUMBERS

Prefixes and numbers in the course numbering system are not chosen at random; they are designed to describe course content in an organized fashion within a classification system developed for each subject matter area.

Generally, each of the major classifications in a discipline is represented by a three-alpha prefix. In some cases, one three-alpha prefix has been sufficient for the entire discipline. A discipline may use as many prefixes as necessary to accommodate its major classifications. The logic of the system allows it to be infinitely expandable with minimal disruption to existing numbers.

History, for example, has seven prefixes. AFH, African History; AMH, American History; ASH, Asian History; EUHM European History; HIS, History General; LAH, Latin American History; and WOH, World History. All history courses in the state will carry one of these prefixes. A more specific example is AMH 3421.

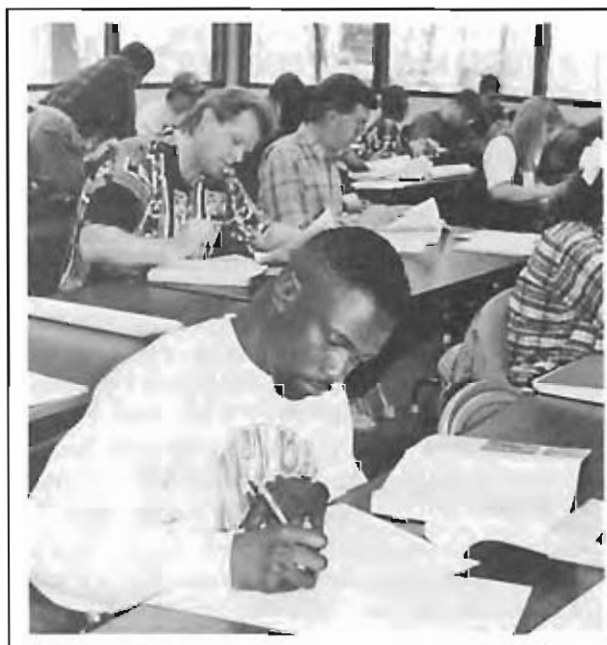

*Students often do coursework on computers, but sometimes "hitting the books" is the best way to tackle a subject.*

## AMH 3421 EARLY AMERICAN HISTORY

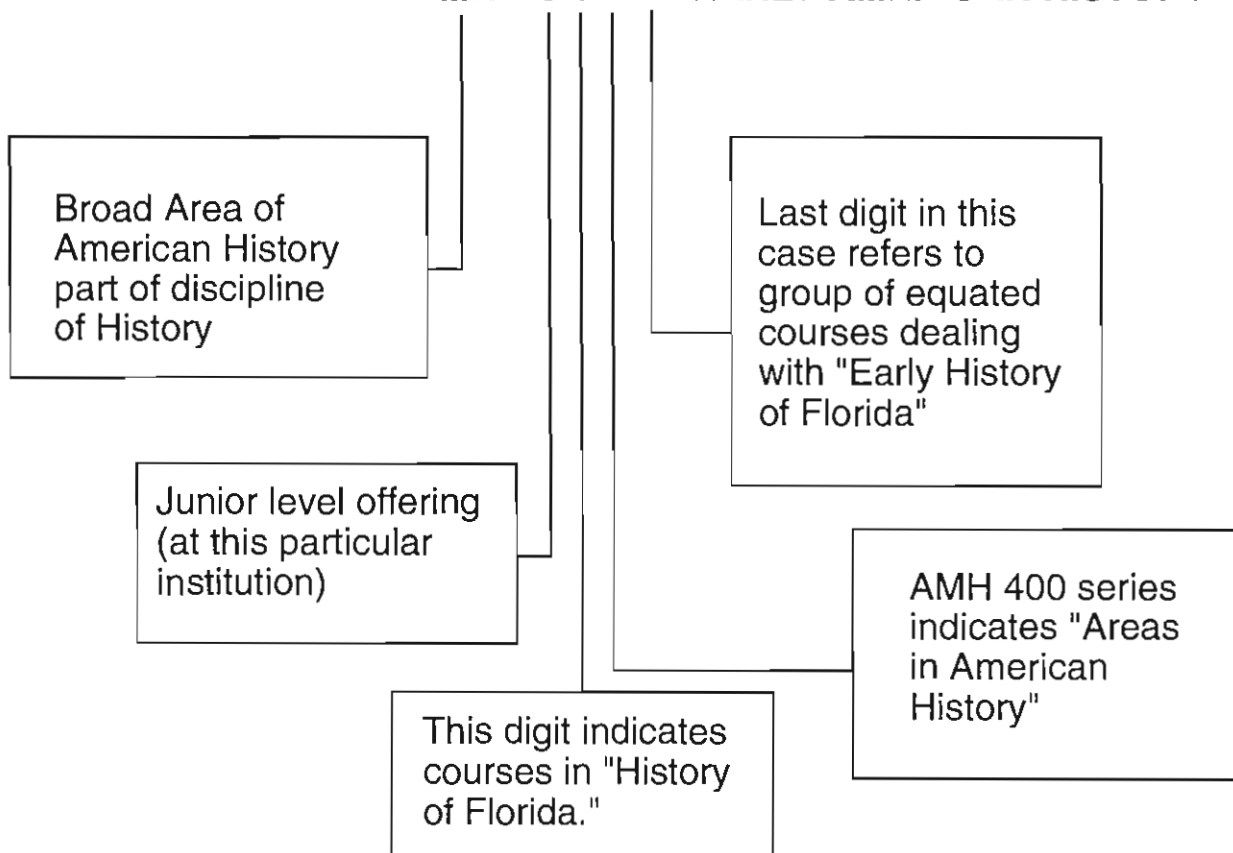

A complete inventory of taxonomy listings, equivalent and unique courses, has been made available to each academic department of every institution in the state. Students, through their local advisors, should use this information in designing programs which will transfer smoothly.

### **EXCEPTIONS TO THE RULE FOR EQUIVALENCIES**

The following are exceptions to the general rule for course equivalencies:

- All numbers which have a second digit of 9 (ex. ART 2905) are "place keeper" numbers for courses which are classified as directed independent study, thesis hours, etc. Courses with -900 numbers must be evaluated individually and are not automatically transferable.
- All internships, practicums, clinical experiences and study abroad courses, whatever numbers they carry, are not automatically transferable .
- Performance or studio courses in art, dance, theatre, and music are not automatically transferable but must be evaluated individually.

### **AUTHORITY FOR ACCEPTANCE OF EQUIVALENT COURSES**

Authority for acceptance of equivalent courses in State Board of Education Rule 6A-10.024(14) which states:

(14) When a student transfers among postsecondary area vocational-technical centers, community colleges, and universities, the receiving institution shall award credit for courses satisfactorily completed at the previous institutions when the courses are judged by the appropriate common course designation and number system faculty task forces to be equivalent to courses offered at the receiving institution and are entered in the course numbering system. Credit so awarded can be used by transfer students to satisfy in these institutions on the same basis as native students.



# COURSE DESCRIPTIONS

<b>Adult Education</b>		<b>Manufacturing &amp; Technology</b>	
Noncredit Courses .....	88	Credit Courses .....	112
		Noncredit Courses .....	120
<b>Athletics &amp; Physical Education</b>		<b>Mathematics</b>	
Credit Courses .....	88	Credit Courses .....	121
<b>Business</b>		<b>Public Safety</b>	
Credit Courses .....	91	Credit Courses .....	122
Noncredit Courses .....	96	Noncredit Courses .....	130
<b>Communications</b>		<b>Sciences</b>	
Credit Courses .....	98	<b>Biological</b>	
Noncredit Courses .....	102	Credit Courses .....	132
<b>Human Development &amp; Continuing Education</b>		Noncredit Courses .....	133
Credit Courses .....	103	<b>Physical</b>	
Noncredit Courses .....	105	Credit Courses .....	133
<b>Humanities, Fine &amp; Performing Arts</b>		<b>Social Science</b>	
Credit Courses .....	106	Credit Courses .....	134
Noncredit Courses .....	112		

## CONTINUING EDUCATION UNITS

In order to provide individuals with an opportunity to meet their educational needs, Okaloosa-Walton Community College offers noncollege-credit Continuing Education courses and awards one noncollege-credit Continuing Education Unit (CEU) for each ten contact hours spent in these courses unless the course is approved by other regulatory agencies. These hours are organized, planned continuing education experiences under the direction and instructional control of the department in which they are offered. These courses may not be used toward any college degree.

Okaloosa-Walton offers two types of Continuing Education units as follows:

- (1) Individual units which are structured to meet the needs of targeted groups or individuals, and the content of these units are selected and organized in a sequential manner, with appropriate objectives and rationale stated in course syllabi.
- (2) Institutional units are less structured and are informal in nature, but are planned educational experiences. These units are designed to meet community needs as they arise, such as community seminars, courses on the aging, etc. No CEU units will be awarded for courses which are entertainment, social or athletic in nature.

## ADULT EDUCATION

### NONCREDIT COURSES (C.E.U.)

For information on Continuing Education Units, see page 87.

#### VPI 0002

**General Education/Vocational Preparatory, 30 to 60 class hours, 3 to 6 c.e.u.'s (Offered as needed)**

A special course designed to help remove basic deficiencies in English, reading, vocabulary, and basic mathematics, thus preparing an individual for advancement in employment, for entering more advanced job training, vocational, or postsecondary adult educational programs.

#### XXX 2601

**Adult Basic Education, 24 to 320 class hours, 2.4 to 32.0 c.e.u.'s (Fall, Spring, Summer)**

Instruction for individuals desiring to improve their basic skills in reading, writing and math. Especially suited for individuals preparing for the G.E.D. examination leading to a Florida High School Diploma or for persons learning English as a second language. The course helps to prepare individuals for gainful employment or for more advanced vocational and/or academic skills.

## ATHLETICS & PHYSICAL EDUCATION

### CREDIT COURSES

#### DAA 1160A\*

**Modern Dance, 2 semester hours, 15 lec., 30 lab. (Offered as needed)**

The beginning modern dance class is designed to affect an understanding of the art of the modern dance at a beginning level. It includes a brief history of the dance, instruction and practice in basic dance techniques, improvisation, and dance forms. This course may be taken up to four (4) times for credit.

#### DAA 1161\*

**Intermediate Modern Dance, 2 semester hours, 15 lec., 30 lab. (Offered as needed)**

The intermediate modern dance class is designed to affect understanding the art of the modern dance at an intermediate level. It includes a continued historical analysis of modern dance; instruction and practice in intermediate dance techniques, improvisation, and dance forms. This course may be taken up to four (4) times for credit.

#### DAA 1200\*

**Beginning Ballet I, 2 semester hours, 15 lec., 30 lab. (Offered as needed)**

Ballet I is a beginning dance course designed to serve as an introduction to the tradition and discipline of the art of classical ballet. Physical development of body as and expressive instrument for ballet movement will be stressed as strength, flexibility, balance, agility, alignment, turn-out, control, elevation and sensitivity to line are studied. This course may be taken up to four (4) times for credit.

#### DAA 1201\*

**Intermediate Ballet, 2 semester hours, 15 lec., 30 lab. (Offered as needed)**

Intermediate Ballet is designed to train the more advanced student in the tradition and discipline of the art of the classical ballet beyond the basics. Physical development of the body as an expressive instrument for ballet movement will continue to be stressed as strength, flexibility, balance, agility, alignment, turn-out, control, elevation, and sensitivity to line are improved. This course may be taken up to four (4) times for credit.

#### DAA 1480\*

**Dance Line, 1 semester hour, 30 lab. (Offered as needed)**

The student shall participate in the preparation and performance of original dance compositions to include dance line performances. This course may be taken up to four (4) times for credit.

#### DAA 1500\*

**Jazz Dance, 1 semester hour, 30 lab. (Offered as needed)**

This course includes a brief history of the jazz dance and instruction and practice in jazz dance techniques exploring popular dance idioms.

#### DAA 1720\*

**Dance Workshop, 1 semester hour, 30 lab. (Offered as needed)**

Instruction and participation in dance as required by specific productions, i.e., Theatre/Show Choir. This course may be taken up to four (4) times for credit.

#### DAA 2721\*

**Dance Workshop II, 1 semester hour, 30 lab. (Offered as needed)**

Continued instruction and participation in dance as required by specific Music Theatre productions. This course may be taken up to four (4) times for credit. Prerequisite: A demonstration of competence required.

#### HLP 1081\*

**Wellness: Practice and Theory, 3 semester hours, 45 lec. (Fall, Spring, & Summer)**

A course designed to promote wellness through assessment, instruction and fitness programs which, if applied, will enable the individual to achieve and/or maintain a high quality of health and fitness throughout life. Based on assessment test results a physical examination by a physician may be recommended.

#### HLP 1082

**Cardiac Wellness, 3 semester hours, 4 lec. (Offered as needed)**

A course designed as a community based cardiac rehabilitation program which includes personal assessment, wellness instruction and cardiac fitness rehabilitation. If applied, the course may enable the individual to prevent further disease complications and/or enhance disease reversal. Prerequisites: Referral from attending physician or hospital based Cardiac Rehabilitation Unit.

\*Activity course fulfills the Physical Education requirement.

**HSA 2102****Health Care Delivery, 3 semester hours, 45 lec. (Offered as needed)**

This course will introduce the student to the health care delivery system in the United States and will provide an overview of the roles and responsibilities of members of the health care team. Common illnesses will be discussed with a focus on prevention of disease and promotion of wellness. The course content will also include communication and interpersonal skills, and infection control (including the state-approved 4-hour course in AIDS prevention) and the personal characteristics of the successful health care professional. Students will demonstrate learned competencies such as vital signs and first aid.

**HSC 1100****Health Education, 3 semester hours, 45 lec. (Offered as needed)**

A systematic and comprehensive coverage of basic factual material, concepts, terminology, and important trends in major health areas of concern today.

**HSC 1400****First Aid, 3 semester hours, 45 lec. (Offered as needed)**

Preparation to meet emergencies that occur in the school, home or on the highway. Instruction and practice in dressing and bandaging, care of wounds, shock, bone and joint injuries, cardiopulmonary resuscitation, transportation of the injured, oral poisoning and other medical emergencies.

**PEL 1111\*****Beginning Bowling, 1 semester hour, 30 lab (Offered as needed)**

The development of skills and practice in the basic fundamentals of bowling.

**PEL 1121\*****Beginning Golf, 1 semester hour, 30 lab. (Offered as needed)**

Instruction in the fundamental technique and the development of personal skills through participation.

**PEL 1211\*****Slow Pitch Softball, 1 semester hour, 30 lab. (Offered as needed)**

Instruction in the basic skills for full participation and enjoyment of the game of softball.

**PEL 1212\*****Advanced Softball, 1 semester hour, 30 lab. (Offered as needed)**

Instruction, practice, and participation in advanced baseball. The continuous development of physical skills is of major importance in this course. May be taken four (4) times for credit. (Athletes)

**PEL 1217\*****Advanced Baseball, 1 semester hour, 30 lab. (Offered as needed)**

Instruction, practice, and participation in advanced softball. The continuous development of physical skills is of major importance in this course. May be taken four (4) times for credit. (Athletes)

**PEL 1321\*****Volleyball, 1 semester hour, 30 lab. (Offered as needed)**

Instruction and practice in the basic skills for full participation and enjoyment of the game of volleyball.

**PEL 1341\*****Beginning Tennis, 1 semester hour, 30 lab. (Offered as needed)**

The history of tennis, the fundamental techniques and the development of personal skills through participation.

**PEL 1342\*****Intermediate Tennis, 1 semester hour, 15 lec., 15 lab. (Offered as needed)**

Instruction, practice, refinement of fundamental techniques; continued development of physical skills through class participation. Prerequisite: PEL 1341 or equivalent.

**PEL 1344\*****Advanced Tennis, 1 semester hour, 30 lab. (Offered as needed)**

Instruction, practice, and participation in advanced tennis. The continuous development of physical skills is of major importance in this course. Departmental approval only. May be taken up to four (4) times for credit.

**PEL 1346\*****Beginning Badminton, 1 semester hour, 30 lab. (Fall, Spring, Summer)**

Instruction and practice in the basic skills for full participation and enjoyment of the game of badminton.

**PEL 1441\*****Beginning Racquetball, 1 semester hour, 30 lab. (Offered as needed)**

Instruction and participation in the skills necessary for satisfactory competition in the sport of racquetball.

**PEL 1511\*****Soccer, 1 semester hour, 30 lab. (Fall) (Offered as needed)**

Introduction in the fundamental techniques and the development of personal skills through participation.

**PEL 1514\*****Advanced Soccer, 1 semester hour, 30 lab. (Offered as needed)**

Instruction, practice, and participation in advanced soccer. The continuous development of physical skills is of major importance in this course. Instructor permission only. May be taken up to four (4) times for credit.

**PEL 1621\*****Basketball, 1 semester hour, 30 lab. (Fall, Spring)**

Instruction and participation in the fundamental aspects of basketball with emphasis on both the mental and motor skill developments.

**PEL 1622M\*****Advanced Basketball, 1 semester hour, 30 lab. (Offered as needed)**

Instruction, practice, and participation in advanced basketball. The continuous development of physical skills is of major importance in this course. May be taken four (4) times for credit. (Athletes)

**PEL 1622W\*****Advanced Basketball (Women), 1 semester hour, 30 lab. (Offered as needed)**

Instruction, practice, and participation in advanced basketball. The continuous development of physical skills is of major importance in this course. May be taken four (4) times for credit. (Athletes)

\* Activity course fulfills the Physical Education requirement.

**PEL 1905\***  
**Independent Study-Physical Education, 1 semester hour, 30 lab. (Fall, Spring, Summer)**

Directed study and/or individual projects designed to meet the needs and interests of students in a specialized area of health, physical education and recreation, for which present course availability is limited.

**PEL 2122\***  
**Intermediate Golf, 1 semester hour, 30 lab. (Offered as needed)**

Designed for those students who wish to improve their knowledge of golf and golf skills beyond the beginner's level.

**PEL 2442\***  
**Intermediate Racquetball, 1 semester hour, 30 lab. (Offered as needed)**

A continuation of skills learned in beginning racquetball with emphasis on more advanced skills and techniques. Particular emphasis is placed on the strategy of the game. Prerequisites: PEL 1441 or permission of instructor.

**PEL 2905**  
**Directed Work Study-Physical Education, 1 semester hour, 45 lab. (Offered as needed)**

Directed experience in instructional, laboratory and/or materials assistance in a designated Physical Education area. Entry by permission of department chair only.

**PEM 1104\***  
**Body Conditioning 1, 2 semester hours, 15 lec., 30 lab. (Fall, Spring, & Summer)**

An in-depth and advanced continuation of the exercise component of HLP 1081. Using progressive goal setting techniques, the course is designed to assist the student in the development of a regular, systemized program of exercise into their daily life-style. Initially, the students' health and fitness levels are evaluated; progress of their personal exercise prescriptions monitored, and followed with a reevaluation at the termination of the course. Prerequisite: HLP 1081. May be taken up to two (2) times for credit.

**PEM 1105**  
**Fitness Concepts, 1 semester hour, 15 lec., 15 lab. (Offered as needed)**

Instruction in the concepts of fitness as related to physical and health components.

**PEM 1111\***  
**Conditioning for Athletes, 2 semester hours, 60 lab. (Offered as needed)**

Using progressive goal setting techniques, the course is designed to assist the student in the development of a regular, systematized program of exercise for participation in athletics. Initially, the students' health and fitness levels are evaluated; progress of their personal exercise prescriptions monitored, and followed with reevaluation of the course. This course is designed to develop the strength, flexibility, and endurance of the athlete and advanced physical education student. May be taken up to four (4) times for credit.

**PEM 1131\***  
**Strength Training, 2 semester hours, 15 lec., 30 lab. (Offered as needed)**

This course is an introduction to the OWCC Strength Center and the use of free weights. Instruction includes, but is not limited to, the history of and principles of weight training, strength center etiquette, safety and nutrition. Instruction will be given on the design of progressive resistance exercise programs to increase total body efficiency and to meet the objectives of the individual student. It is recommended, and in some cases may be required, that the student obtain medical approval before participating in this course. May be taken two times for credit.

**PEM 1171\***  
**Aerobic Dance, 1 semester hour, 30 lab. (Offered as needed)**

Instruction and participation in a physical fitness program that offers conditioning of the figure muscles and of the cardiovascular system through dance activities.

**PEM 1181\***  
**Walk/Jog I, 2 semester hours, 60 lab. (Fall, Spring)**

Instruction and participation in a safe program of walking, jogging, running, and related aerobic activities.

**PEM 1182\***  
**Walk/Jog II, 2 semester hours, 60 lab. (Fall, Spring)**

A continuation of skills learned in PEM 1145. Student will be trained using the point system with appropriate evaluation of progress.

**PEM 1183\***  
**Walk/Jog III, 1 semester hour, 30 lab. (Summer only)**

An introduction to aerobic exercise with emphasis on correct techniques, safety, benefits, quality, and quantity of exercise and evaluation of progress.

**PEM 1184\***  
**Walk/Jog IV, 1 semester hour, 30 lab. (Summer only)**

A continuation of skills learned in PEM 1143. Student will be trained using the point system with appropriate evaluation of progress.

**PEM 1330\***  
**Orienteering, 1 semester hour, 30 lab. (Offered as needed)**

Development of skills needed to navigate through an unknown area using a map and compass as a guide.

**PEM 1953\***  
**Cheerleading, 1 semester hour, 30 lab. (Offered as needed)**

Cheerleading is an activity physical education course providing cheerleading for basketball and specific performances. Physical development of the body for fitness, strength, flexibility, balance, agility, control, dance and tumbling will be studied. This course may be taken up to four (4) times for credit.

**PEM 2013**  
**Tutorial: Education and Physical Education, 1 semester hour, 30 lab. (Fall, Spring, Summer)**

An experience in individual depth study in which one student prepares for and engages in tutoring another for two (2) class periods per week.

**PEM 2108\***  
**Fitness Lab, 1 semester hour, 30 lab. (Offered as needed)**

Instruction and participation in an exercise program with emphasis on muscle endurance, strength and flexibility. May be taken up to four (4) times for credit.

\*Activity course fulfills the Physical Education requirement.

**PEM 2172\*****Aerobic Dance II, 1 semester hour, 30 lab. (Offered as needed)**

Advanced level of instruction and participation in a physical fitness program that offers conditioning of the figure muscles and of the cardiovascular system through dance activities. Prerequisite: PEM 1171.

**PEN 1251\*****Basic Canoeing, 1 semester hour, 30 lab. (Summer)**

This course is designed to develop safety and fundamental skills in the use of canoes.

**PEO 1218****Baseball/Softball Officiating, 2 semester hours, 15 lec., 30 lab. (Offered as needed)**

Instruction in rule interpretations and practice in the fundamental techniques required in baseball/softball officiating.

**PEO 1623****Basketball Officiating, 2 semester hours, 15 lec., 30 lab. (Offered as needed)**

Instruction in rule interpretations and practice in the fundamental techniques required in basketball officiating.

**PEO 2513****Soccer Refereeing, 2 semester hours, 15 lec., 30 lab. (Offered as needed)**

Instruction in rule interpretations and practice in the fundamental techniques required in soccer officiating.

**PET 1020****Introduction to Physical Education, 3 semester hours, 45 lec. (Offered as needed)**

A study of the history of physical education and sport with particular emphasis placed on present practices and trends.

**PET 2622****Care and Prevention of Athletic Injuries, 3 semester hours, 45 lec. (Offered as needed)**

Designed to provide students with a basic knowledge of the care, prevention, and rehabilitation of injuries received during participation in physical education activities.

**BUSINESS****CREDIT COURSES****ACG 2001****Accounting I, 3 semester hours, 45 lec., (Fall, Spring, Summer)**

Principles of Accounting provide the foundation for: accounting information system; double entry system; balance sheet, income statement, and adjustments; completion of the accounting cycle; merchandising and special journals; internal control and the voucher system; short-term liquid assets; inventory methods; liabilities and payroll; acquire, depreciate, and dispose of assets; revenue or capital expenditure, asset depletion and amortization. Problems and computer-assisted accounting practice exercise are required. Prerequisite: Computer Literacy.

**ACG 2011****Accounting II, 3 semester hours, 45 lec. (Fall, Spring, Summer)**

Partnership formation and liquidation corporate stock and capital equity transactions, financing with long-term liabilities, branch and departmentalization, job order and process costing, budgetary control and standard costing and differential analysis, cost volume profit analysis and quantitative techniques, funds flow and financial position statements, consolidation; pooling and purchasing, and analyzing interpreting statements. Prerequisites: ACG 2001.

**ACG 2071****Managerial Accounting, 3 semester hours, 45 lec. (Offered as needed)**

The basic principles of accounting techniques for the preparation of internal reports related to the management of the firm and the interpretation of financial data useful in the decision-making process within the economic framework of the firm. Prerequisites: ACG 2001, ACG 2011.

**APA 1003****Accounting Fundamentals I, 3 credits, 45 lecture hours (Offered as needed)**

Fundamentals of Accounting I will introduce the student who has no accounting background to accounting for assets, liabilities, and owner's equity of a sole proprietorship. The student will review documents, record transactions in journals, post to ledgers, prepare work sheets, trial balances and financial statements, including: balance sheets, income statements and statement of owner's equity, to complete the accounting cycle. Accounting Fundamentals I and II are required to fulfill the Principles of Accounting I requirements for upper division transfer program. This course and APA 1004 will help students prepare for the satisfactory completion of ACG 2011.

**APA 1013****Accounting Fundamentals II, 3 credits, 45 lecture hours (Offered as needed)**

Fundamentals of Accounting II will expand the knowledge the student gained in Fundamentals of Accounting. The student will be introduced to the protection of and accounting for assets and liabilities in the merchandising operation. The student will expand his knowledge of financial statement and accounting procedures. The scope of the student will be broadened as he learns accounting for specific types of assets including accounts receivable and bad debts. The student will work with accounting for payroll and appropriate withholding and payroll taxes. Some problems will be worked on the computer so that the student will view the computer as an efficient tool in solving accounting problems and making the book-keeping tasks more efficient. Accounting Fundamentals I and II are required to fulfill the Principles of Accounting I requirements for upper division transfer program. This course and APA 1003 will help students prepare for the satisfactory completion of ACG 2011.

**BAN 1004****Principles of Bank Operations, 3 semester hours, 45 lec. (Offered as needed)**

This course represents the fundamentals of bank functions in a descriptive fashion so that the beginning banker may acquire a broad (and operational) perspective. The descriptive orientation is intentional.

\*Activity course fulfills the Physical Education requirement.

**BAN 2210**

**Analyzing Financial Statements, 3 semester hours, 45 lec. (Offered as needed)**

This course presents the fundamentals of financial statement analysis. It is intended to train the student in the use of tools and techniques necessary for the evaluation of the financial condition and operating performance of a business enterprise. Prerequisite: ACG 2001.

**BAN 2501**

**Money and Banking, 3 semester hours, 45 lec. (Offered as needed)**

This course stresses the practical aspects of money and banking and emphasizes the basic inventory theory needed by the banking student to apply knowledge acquired on the job. Historical treatment is kept to a minimum. Emphasis is also placed on such problems as economic stabilization, types of spending, the role of gold, limitations of central bank control, government fiscal policy, balance of payments, and foreign exchange. Prerequisite: ECO 2013/2023.

**BAN 2900**

**Directed Study-Banking, 1 semester hour, 30 lab. (Offered as needed)**

A directed study designed to enable the student interested in banking to pursue an in-depth study of a specialized area of banking.

**BAN 2920M\***

**Introduction to Securities, 1 semester hour, 15 lec. (Offered as needed)**

This course describes how the various securities markets operate, the products they offer, how the products compare to traditional programs, and how to market products to customers.

**BAN 2920N**

**Lotus I (Electronic Spreadsheets), 1 semester hour, 15 lec. (Offered as needed)**

An introduction to the use of software, such as Lotus 1-2-3, as a work tool. The spreadsheet is also examined and used in practical exercises.

**BUL 2241**

**Business Law I, 3 semester hours, 45 lec. (Fall, Spring, Summer)**

Introductory course in business law with objective of presenting the law underlying business transactions. Course includes the study of the Law of Contracts, the Law of Bailments, and the law of sales based on the UNIFORM COMMERCIAL CODE. Recommended for all business students.

**BUL 2242**

**Business Law II, 3 semester hours, 45 lec. (Fall, Spring, Summer)**

Course context explores laws relative to Negotiable Instruments, Agency, Partnerships, (includes study of Uniform Partnership Act), Corporation Law, Creditors Rights, Consumer Protection and Insurance. Based on Uniform Commercial Code.

**CGS 1000**

**Introduction to Computer Programming, 3 semester hours, 45 lec., 45 lab. (Offered as needed)**

An introduction to the BASIC (Beginner All Purpose Symbolic Instruction Code) programming language and flowcharting. Stresses the importance of logical and proper documentation of programs. Designed for students to use knowledge obtained as a tool in their chosen field. Prerequisite: CIS 1000.

**CGS 1060**

**Computer Literacy, 3 semester hours, 45 lec. (Offered as needed)**

An overall view of computers and how they affect each person as well as society. Hands-on experience is provided. Recommended for non data processing majors.

**CGS 1520**

**Introduction to Harvard Graphics 3.0, 1 semester hour, 30 lab. (Offered as needed)**

An introduction to use of Harvard Graphics 3.0 (DOS) for the creation of business graphics and presentations.

**CGS 1931F**

**Computer Tools for the Teacher, 3 semester hours, 45 lec. (Offered as needed)**

This course is designed to introduce and familiarize students to microcomputer tools which will streamline classroom management. Students will be introduced to the word processor, database managers, spreadsheets, test makers, and graphics packages. Prerequisite: EME 1920 or prior experience with microcomputers in education.

**CGS 1931G**

**Teaching Writing Using a Microcomputer, 3 semester hours, 45 lec. (Offered as needed)**

This course is designed to teach students the writing process and use of a word processor in writing instruction. Students will evaluate and use other software for teaching writing. Prerequisite: EME 1920 or prior experience with microcomputers in education. Prerequisite: CGS 1931F, Computer Tools for the Teacher.

**CGS 2423**

**Programming In C, 3 semester hours, 45 lec. (Offered as needed)**

An introduction to ANSI compatible C programming using microcomputers.

**CGS 2450**

**Microcomputing for Business, 3 semester hours, 45 lec. (Offered as needed)**

An introduction to using computer software (Word Perfect, Lotus 1-2-3, and dBase) to facilitate the interaction of measurement, analysis, and reporting of accounting information. Prerequisite: CGS 1060, ACG 2001.

**CGS 2510**

**Introduction to Electronic Spreadsheets, 2 semester hours, 30 lec. (Offered as needed)**

An introduction to the use of integrated software, such as Lotus 1-2-3, as a problem solving tool. The spreadsheet, database, and graphics features are examined and used in practical exercises.

**CGS 2540**

**Introduction to dBase III, 2 semester hours, 30 lec. (Offered as needed)**

An introduction to file creation, maintenance, and report generation using dBase III. Covers both interactive applications and programming with dBase III.

**CGS 2560**

**MS-DOS/Microcomputer, 1 semester hour, 15 lec. (Offered as needed)**

An introduction to the use of the microcomputer and the disk operating system (DOS).

\*Occupational course that may not be applied toward the A.A. Degree.

**CGS 2570****Introduction to Windows, 3 semester hours, 45 lec. (Offered as needed)**

An introduction to operating systems in general with emphasis on DOS and Windows. Prerequisite: CGS 1060 or equivalent.

**CGS 2571****WordPerfect I, 3 semester hours, 30 lec. , 30 lab. (Offered as needed)**

Instructs the student in the theories and practical applications of word processing using WordPerfect software. The goal of the course is to prepare the student for employment, home use, or personal use (such as term papers for college students). Prerequisites: Recommend MS/DOS: typing required.

**CGS 2572****WordPerfect II, 3 semester hours, 30 lec. , 30 lab. (Offered as needed)**

Continuation of CGS 2571 – WordPerfect I – with advanced techniques of building tables, creating newspaper and parallel columns, text columns, graphics and desktop publishing. Prerequisite: CGS 2571 or equivalent.

**CGS 2573****Introduction to WordPerfect, 2 semester hours, 30 lec. (Offered as needed)**

Introduction to Word Perfect software functions by providing basics of the software: Loading the Program, Entering and Editing Text, Formatting, Printing, Merge Printing, Desktop Publishing.

**CGS 2574****Introduction to Word Star, 2 semester hours, 30 lec. (Offered as needed)**

Introduction to Word Star software by emphasizing the functions of the program: MENUS, COMMANDS/DISPLAY CHARACTERS/FLAG CHARACTERS, KEYBOARD OPERATIONS, FINDING WORDS AND CHECKING SPELLING, PRINTING, MERGE PRINTING.

**CGS 2575****Desktop Publishing, 2 semester hours, 45 lec. (Offered as needed)**

Continuation of CGS 2573 with advanced techniques on how to build tables, create newspaper and parallel columns and desktop features. Prerequisite: CGS 2572 or equivalent.

**CIS 1000****Data Processing Concepts, 3 semester hours, 45 lec. (Fall, Spring, Summer)**

A beginning course in data processing designed for both the data processing major as well as those students who need a general understanding of the modern computer. A broad overview of digital computers including history of computers, number systems, punched card processing, storage concepts, coding systems, and input/output systems.

**COP 2000****Programming I, 3 semester hours, 45 lec. (Offered as needed)**

Designed for data processing majors, uses top-down design, structure logic, and a higher level language to solve problems on a computer. Stresses proper documentation of programs to be used in a computer center. Prerequisite: CIS 1000 or equivalent and proficiency in basic algebra required.

**COP 2001****Programming II, 3 semester hours, 45 lec. (Offered as needed)**

A sequel to Programming I, intended to fully exercise all facilities of a high-level programming language in the solution of more advanced problems. Prerequisite: CIS 1000, COP 2000.

**COP 2120****COBOL Programming, 3 semester hours, 45 lec. (Offered as needed)**

A survey of an introduction to COBOL programming. Historical development, general concepts and state of the art. COBOL is introduced with emphasis on problem solving. Emphasis on methods of analyzing business problems for computer adaptation. Prerequisites: CIS 1000, COP 2000, COP 2001, or equivalent.

**COP 2200****FORTRAN Programming, 3 semester hours, 45 lec. (Offered as needed)**

An introduction to the computer programming language of FORTRAN. Includes general introduction to computer programming, general programming concepts, elementary problem solving and flowcharting. Involves actual problem solving by the use of the FORTRAN language on the computer. Prerequisites: CIS 1000, COP 2000, COP 2001, or equivalent.

**COP 2400****IBM Assembler Language, 3 credit hours, 45 lec. (Offered as needed)**

An introduction to assembler language programming for the IBM System/370 family of computers. Prerequisites: CIS 1000, COP 2000, COP 2001, or equivalent.

**ECO 2013****Economics I, 3 semester hours, 45 lec. (Fall, or as needed)**

Macroeconomics. Basic concepts and principles, national income accounting; fiscal and monetary policy and application, growth economics. Will satisfy General Education elective. Basic math skills required.

**ECO 2023****Economics II, 3 semester hours, 45 lec. (Spring, or as needed)**

Microeconomics. Economic structures, price theory, factor markets, and general equilibrium. Current national and international problems. World trade and balance of payments. Comparative economics. Will satisfy General Education elective. Prerequisite: ECO 2013 or equivalent.

**EME 1920****Computer Application Skills Workshop, 1 semester hour, 20 lec. (Offered as needed)**

A workshop to provide an overview of computer applications to gain an understanding of hardware and software terminology and use, and supply an introduction to software utilization for the classroom teacher.

**FIN 2001\*****Industrial Finance, 3 semester hours, 45 lec. (Offered as needed)**

The course presents the principles of financial management and explains the process of financial management from a viewpoint of the financial manager. Included also are the time value of money, cost of capital, dynamic and operating environments, capital investment, working capital, inventories and other related topics.

\*Occupational course that may not be applied toward the A.A. Degree.

**FSS 1202C\*****Beginning Food Preparation I, 6 semester hours, 45 lec., 135 lab. (Offered as needed)**

The first course in the commercial foods program. Topics covered include: safe operation of food preparation equipment, beginning food preparation skills, food preparation utensils, desirable work habits, safety practices, and human relations.

**FSS 1203C\*****Beginning Food Preparation II, 6 semester hours, 45 lec., 135 lab. (Offered as needed)**

A study of basic food preparation on a small quantity basis. Topics covered include: preparation of meats, vegetables, salads, and desserts; the three basic food groups and their relationship to nutrition; vitamin and mineral content of foods and their relationship to good health.

**FSS 1221\*****Quantity Foods Preparation I, 6 semester hours, 45 lec., 135 lab. (Offered as needed)**

A study of food preparation in quantity. Topics covered include: wholesale and retail cuts of meat; time and temperature factors in quantity cooking; balanced nutritional menu planning; the U.S. Department of Agriculture grading system for meats; complimenting meals with salads and baked goods.

**FSS 1222\*****Quantity Foods Preparation II, 6 semester hours, 45 lec., 135 lab. (Offered as needed)**

An advanced study of quantity food preparation. Topics covered include: progressive cooking for large groups of people; and advanced menu planning for large groups.

**FSS 1246C\*****Commercial Baking, 6 semester hours, 45 lec., 135 lab. (Offered as needed)**

A study of baking practices and principles as they apply to the preparation of breads, rolls, pastries, pies, cakes, cookies, and specialty desserts.

**GEB 1011****Introduction to Business, 3 semester hours, 45 lec. (Fall, Spring, Summer)**

Designed to give students a broad understanding of the nature of business and a preliminary idea of the various areas of business specialization.

**GEB 1940\*****Internship-Business Education, 3 semester hours, 225 lab. (Offered as needed)**

On-the-job training in the Associate of Science/Applied Science Option program in which the student is enrolled. The student is under the supervision at work of a qualified supervisor. The supervisor will rate the student's performance, knowledge, comprehension, dependability, initiative, cooperativeness, and total performance. A project paper or approved project will be submitted by the student three weeks prior to the close of the semester. May be repeated four times for a total of 12 semester hours.

**GEB 2903 Tutorial-Business, 1 semester hour, 30 hours (Fall, Spring, Summer)**

An experience in individual depth study in which one student prepares for and engages in tutoring another for two class periods per week.

**HFT 2261\*****Restaurant Management I, 6 semester hours, 45 lec., 135 lab. (Offered as needed)**

A course designed to provide the student with the general principles of production management, work scheduling and preparation supervision.

**HFT 2262\*****Restaurant Management II, 6 semester hours, 45 lec., 135 lab. (Offered as needed)**

A course designed to provide the student with the general principles of total food service management, menu planning, purchasing, inventory control, cost control and service techniques.

**MAN 2021****Management, 3 semester hours, 45 lec. (Offered as needed)**

Each function of management is analyzed and described in a systematic manner. Both the distilled experience of practical managers and the findings of scholars are presented. Other aspects of management are presented such as management process and concepts analysis of the technical knowledge and skills of managers, influences upon managerial decision-making process, and the psychological principles inherent in management.

**MAN 2300****Personnel Management, 3 semester hours, 45 lec. (Offered as needed)**

An introduction to personnel practices and procedures. Topics include the personnel management system, maximizing employee potential, organizational behavior, and labor management relations.

**MAN 2905****Independent Study-Business, 1 semester hour, 15 lec., 30 lab. (Fall Spring, Summer)**

Directed study and individual projects designed to meet the needs of students interested in specialized areas of business for which present course availability is limited. Areas of study can also be supplemented to present business courses for special emphasis or depth.

**MAN 2940****Directed Work Study-Business, 1 semester hour, 45 lab. (Fall, Spring, Summer)**

Directed experience in instructional, laboratory and/or materials assistance in a designated business area.

**MAR 2011****Introduction to Marketing, 3 semester hours, 45 lec. (Offered as needed)**

An introductory course in the field of marketing including a look at marketing as it exists in our economy today. Consideration of the market, the product, distribution channels. Special emphasis on the study of human behavior in marketing promotion.

**MKA 1610\*****Industrial Marketing, 3 semester hours, 45 lec. (Offered as needed)**

The course presents the fundamental principles of marketing and explains marketing concepts. Included also are planning, markets, product development, pricing, promotion and other related topics.

\*Occupational course that may not be applied toward the A.A. Degree.



**MKA 2021****Salesmanship, 3 semester hours, 45 lec. (Offered as needed)**

Selling, correct attitudes and personal attributes for dealing with the public on a business or professional basis.

**MKA 2041****Retail Management, 3 semester hours, 45 lec. (Offered as needed)**

Retail store management, location, buying merchandise, control policies, services, pricing, expenses, profits; training and supervision of retail sales forces, administrative problems. Also includes a variety of current perspectives in retailing management.

**MKA 2511****Introduction to Advertising, 3 semester hours, 45 lec. (Offered as needed)**

Advertising as a marketing tool, its planning, creation, and use. A survey of copy writing, layout, and media (newspapers, magazines, radio, television, films, etc.)

**MNA 1015\*****Industrial Management I, 3 semester hours, 45 lec. (Offered as needed)**

The course presents the functions of a manager, the views, techniques, and responsibilities of management. Included also are planning, forecasting, organizing, theory, staffing, and other related topics.

**MNA 1345\*****Supervision I, 3 semester hours, 45 lec. (Offered as needed)**

The course presents the functions of a personnel manager, philosophy of general management, organizational structure, employer socio-economic climate and career information. Included also are job descriptions and specifications, recruiting practices, applications, resumes, interviewing, placement, performance appraisals, wage and salary administration and other related topics.

**MNA 1346\*****Supervision II, 3 semester hours, 45 lec. (Offered as needed)**

The course presents a continuing study of the functions of a personnel manager, philosophy of general management, employee socio-economic climate and other information. Included, also, are orientation, training, labor unions, safety, health and other related topics.

**MNA 2100****Human Relations, 3 semester hours, 45 lec. (Fall, Spring, Summer)**

Designed to help students develop an understanding of how they may be motivated to work together in greater harmony in all kinds of organizations. The basis of human motivation and how it is influenced by leadership, the organization itself, and the social environment in which the organization exists.

**MNA 2301\*****Industrial Management II, 3 semester hours, 45 lec. (Offered as needed)**

The course presents a continuing study of management, the views, techniques and responsibilities. Included are employee relations, communications, controls and other related topics.

**MTB 1103****Business Mathematics, 3 semester hours, 45 lec. (Fall, Spring, Summer)**

Presents basic principles used to solve everyday business problems, including a review of basic skills and business terminology. Topics in the course include: base, rate and percentage; trade and cash discounts, wage and salary administration; insurance (fire and automobile); depreciation and business profits; distribution of corporate dividends; simple interest and bank discount and buying and selling of corporation bonds and stocks.

**OST 1100****Typewriting I, 2 semester hours, 15 lec., 45 lab. (Fall, Spring, Summer)**

Development of correct typewriting techniques, learning the keyboard, problem typing including letters, and reports.

**OST 1107****Document Processing I, 3 semester hours, 30 lec. (Offered as needed)**

Integration of basic keyboarding and wordprocessing (WordPerfect) – learning the keyboard, creating, editing, saving, and other wordprocessing functions.

**OST 1110****Intermediate Typewriting, 2 semester hours, 15 lec., 45 lab., (Fall, Spring)**

Production typing, tabulation, business letter writing, reports, and manuscript typing. Prerequisite: Typewriting I or acceptable level of competency.

**OST 1141****Keyboarding, 1 semester hour, 15 lec. (Offered as needed)**

A basic course in keyboarding using the touch system. The proper techniques for keyboarding alphabetic and numeric data will be emphasized.

**OST 1211****Basic Shorthand, 3 semester hours, 30 lec., 45 lab. (Fall, Spring)**

Basic skills and vocabulary of shorthand. Beginning of dictation and transcription.

**OST 1212****Intermediate Shorthand, 3 semester hours, 30 lec., 45 lab. (Fall, Spring, Summer)**

Speed-building in taking dictation and transcription. Prerequisite: Dictation experience or equivalent.

**OST 1355****Records Management, 3 semester hours, 45 lec. (Fall, Spring, Summer)**

Methods and systems of records management used in business offices, materials and equipment, and time-and-motion saving skills. Practice sets are used.

**OST 1601****Machine Transcription, 3 semester hours, 30 lec., 45 lab. (Offered as needed)**

Operation of recorders and transcribers to develop transcription skills in English grammar, punctuation, sentence structure, and vocabulary. Advanced problems in producing and handling typewritten documents of all kinds. Letters with variations, real estate, medical, legal, and general correspondence. Prerequisite: Typing I or equivalent.

\*Occupational course that may not be applied toward the A.A. Degree.

**OST 2117**  
**Document Processing II, 3 semester hours, 30 lec., 30 lab. (Offered as needed)**

Continuation of Document Processing I – develop keyboarding and document processing using a micro-computer. Prerequisite: OST 1107 or equivalent.

**OST 2120**  
**Advanced Typewriting, 3 semester hours, 15 lec., 45 lab. (Offered as needed)**

Development of occupational proficiency in production typing of business, government, legal, and medical materials. Prerequisite: OST 1110 or equivalent.

**OST 2127**  
**Document Processing III, 3 semester hours, 30 lec., 30 lab. (Offered as needed)**

Development of occupational proficiency in business letter writing, legal papers, executive forms and papers, and manuscripts through the use of a word processor (WordPerfect). Prerequisite: OST 2117 or equivalent.

**OST 2213**  
**Advanced Shorthand, 3 semester hours, 30 lec., 45 lab. (Offered as needed)**

Mailability of transcribed shorthand notes. Accuracy of transcripts, speed in dictation, office routines. Prerequisite: OST 1212 or equivalent.

**OST 2335**  
**Business Communication, 3 semester hours, 45 contact hours, 3 lec. (Offered as needed)**

Business Communications is a comprehensive coverage of language structure and particular emphasis on writing superior business letters and reports. Instruction in principle, then illustration, and practice in applying the principles. A fundamental concept of the appearance, language and style, tone and psychology of effective business letters. Prerequisites: passing score on English placement test or passing grade of "C" in LIN 1670.

**OST 2401**  
**General Office Management, 3 semester hours, 30 lec., 30 lab. (Offered as needed)**

Study of practices and procedures in the modern office. Emphasis on exercising judgment, handling incoming calls and callers, processing mail, word processing systems, editing and composing techniques, travel arrangements, banking procedures, employment applications and resumes. Prerequisite: OST 1110, OST 2335 or equivalent.

**OST 2402**  
**Secretarial Office Management, 3 semester hours, 30 lec., 30 lab. (Offered as needed)**

Emphasis is placed on the primary duties of professional secretaries, including essential nontechnical skills such as decision making, the exercise of initiative, follow-through, working with people, solving office related problems, and effective management of time and materials. Prerequisite: OST 1110, OST 1211 and OST 2335.

\*Occupational course that may not be applied toward the A.A. Degree.

**REE 1040A**  
**Introduction to Real Estate: Course I, 4 semester hours, 63 lec. (Fall, Spring, Summer)**

This course is intended to provide the prospective licensee with the fundamental knowledge in the field of real estate principles and practices and real estate law. This is the required course prescribed by the Florida Real Estate Commission for a person desiring to become registered as a real estate salesperson.

**REE 1200**  
**Real Estate Finance, 3 semester hours, 45 lec. (Offered as needed)**

Designed to explore in detail the many facets of real estate financing with emphasis given to legal aspects, sources of funds, methodologies of major lending institutions, and the effects of high interest rates.

**REE 2300**  
**Real Estate Law, 3 semester hours, 45 lec. (Offered as needed)**

Designed to assist the student to become a more knowledgeable, and potentially, a more successful investor. Emphasis will be given to basic investment fundamentals, income tax consideration, ownership forms for investment, financing the investment and analyzing property investment returns.

**SLS 1341\***  
**Job Search Techniques, 1 semester hour, 15 lec. (Offered as needed)**

A course designed to assist students assess interests, aptitudes, abilities and acquire skills necessary to conduct a job search, obtain employment, and maintain employment. The course will cover such topics as current job search techniques, skills identification, resume writing, interview skills, job retention skills and career exploration.

**TAX 2000**  
**Federal Income Tax: Individual, 3 semester hours, 45 lec. (Offered as needed)**

Determine income tax liability for individuals interpretations of Internal Revenue Code and Regulations, tax planning and advisory service. Brief introduction to partnership, corporation, estate and gift taxes. Extensive practice problems in individual income tax returns and research in tax questions.

## **BUSINESS**

### **NONCREDIT COURSES (C.E.U.)**

For information on Continuing Education Units, see page 87.

**ACO 0101**  
**Bookkeeping I, 60 class hours, 6 c.e.u.'s (Offered as needed)**

Complete bookkeeping cycle, including journalizing, posting, preparing financial statements, and adjusting and closing the books. Procedures for proprietorships, partnerships, corporations, inventory methods, control accounts, special journals, and voucher systems, notes and drafts, depreciation and payroll methods are also included.

**ACO 0102****Bookkeeping II, 60 class hours, 6 c.e.u.'s (Offered as needed)**

Theory and accounting procedures for merchandising, manufacturing concerns, and the principles of cost accounting. Profit and loss analysis, comparative statements, ratios, adjustments, and various cost accounting systems. Attention to income, income tax and official Social Security tax laws, returns, and accounting procedures. Prerequisite: ACO 0101.

**COC 0020N****Introduction to Computers, 45 class hours, 4.5 c.e.u.'s (Offered as needed)**

An overall view of computers and how they affect each person as well as society. Hands-on experience on microcomputers provided.

**FSS 0220C****Commercial Foods and Catering, 90 class hours, 30 lec., 60 lab., 9 c.e.u.'s (Offered as needed)**

An introductory course in commercial food preparation and catering. The student will develop knowledge and skill in the preparation of food, including preparations used in the food service industry. Laboratory experiences are required.

**XXX 1118A****Real Estate Law, 3 class hours, 3 c.e.u.'s (Offered as needed)**

A required post-registration course for real estate salesmen and brokers to update registrant's knowledge of their legal responsibilities. Prerequisite: Real Estate License.

**XXX 1119A****Residential Appraisal, 11 class hours, 1.1 c.e.u.'s (Offered as needed)**

An elective course for real estate sales people and brokers to update licensee's knowledge of residential valuation principles. Prerequisite: Florida Real Estate License.

**XXX 1122A****Income Capitalization Approach, 11 class hours, 1.1 c.e.u.'s (Offered as needed)**

An elective course for real estate sales people and brokers to update registrant's knowledge of the income capitalization approach in real estate appraising. Prerequisite: Florida Real Estate License.

**XXX 1123A****Residential Selling, 11 class hours, 1.1 c.e.u.'s (Offered as needed)**

This block of instruction is designed to: (1) emphasize the responsibilities of licensees to the public in listing residential properties of sale, and (2) enhance the skills of licensees in marketing residential properties. Prerequisite: Florida Real Estate License.

**XXX 1148****Programming the Computer, 45 class hours, 4.5 c.e.u.'s (Offered as needed)**

An introduction to the BASIC (Beginning All Purpose Symbolic Instruction Code) programming language and flowcharting. Stresses the importance of logical and proper documentation of programs. Designed for students to use knowledge obtained as a tool in their chosen field.

**XXX 1600****Beginning Shorthand I, 60 class hours, 6 c.e.u.'s (Offered as needed)**

Basic skills and vocabulary of Gregg Shorthand Series 90. Beginning of dictation, transcription, and development of rapid reading and writing ability on familiar materials.

**XXX 1601****Beginning Shorthand II, 60 class hours, 6 c.e.u.'s (Offered as needed)**

Enlargement of vocabulary in Gregg Shorthand Series 90. Intensive dictation on familiar material and an introduction to transcription to bring the student closer to a degree of vocational skill in dictation and transcribing it in mailable form. Prerequisite: XXX 1600.

**XXX 1602****Refresher Shorthand, 20 class hours, 2 c.e.u.'s (Offered as needed)**

This course will assist students to enlarge their vocabularies in the Gregg Shorthand system, and increase speed and accuracy in successfully transcribing notes.

**XXX 1603****Typewriting Improvement, 15 class hours, 1.5 c.e.u.'s (Offered as needed)**

A course designed to review basic typing techniques and correct technique difficulties in order to acquire the minimum speed required for individual AFSC.

**XXX 1606****Beginning Typewriting I, 60 class hours, 6 c.e.u.'s (Offered as needed)**

Development of skills, techniques, and knowledge in the use of the typewriter for work in a business office in a clerical or stenographic position.

**XXX 1609****Beginning Typewriting II, 60 class hours, 6 c.e.u.'s (Offered as needed)**

Speed building through basic technique, tabulation, business letter writing, reports, and manuscript typing. Prerequisite: OST 1100 or XXX 1606 or acceptable level of competency.

**XXX 1611****Programming Lab, 45 class hours. Hands-on application of BASIC (Beginner All Purpose Symbolic Instruction Code). (Offered as needed)**

Should be taken in conjunction with XXX 1148.

**XXX 1620****Basic Management for Supervisors, 20 class hours, 2 c.e.u.'s (Offered as needed)**

Managerial functions — planning, organizing, staffing, directing, and controlling — are analyzed, described and discussed for the edification of each student.

**XXX 1663A****Course I. Real Estate Principles and Practices, 63 class hours, 6.3 c.e.u.'s (Fall, Spring, Summer)**

This course is intended to provide the prospective licensee with the fundamental knowledge in the field of real estate principles and practices and real estate law. This is the required course prescribed by the Florida Real Estate Commission for persons desiring to become licensed as real estate salesmen.

**XXX 1668**

**Real Estate Investing, 45 class hours, 4.5 c.e.u.'s (Offered as needed)**

Designed to assist the student to become a more knowledgeable and, potentially, a more successful investor. Emphasis will be given to basic investment, fundamental income tax considerations, ownership forms for the investment, financing the investment, and analyzing and projecting investment returns.

**XXX 1669**

**Real Estate Financing, 45 class hours, 4.5 c.e.u.'s (Offered as needed)**

Designed to explore in detail the many facets of real estate financing with emphasis given to legal aspects, sources of funds, methodologies of major lending institutions, and the effects of high interest rates.

Determining income tax liability for individuals, preparation of tax returns, and interpretations of Internal Revenue code and regulations.

**XXX 1902**

**Personnel Management, 40 class hours, 4 c.e.u.'s (Offered as needed)**

A course of instruction designed primarily for first and second level supervisors embodying coverage of principles of personnel administration as pertain to the line organization. Subjects include: classification, employment, training, labor relations, equal employment opportunity, and employee-management subject matter.

**XXX 1926**

**Office Management, 24 class hours, 2.4 c.e.u.'s (Offered as needed)**

A course designed to provide a review and update of office management skills such as leadership, motivation, productivity, work distribution, etc., for use in office administration.

**XXX 1929**

**Filing, 45 class hours, 4.5 c.e.u.'s (Offered as needed)**

Methods and systems of filing used in business offices, filing equipment, and time-and-motion saving skills. Filing practice sets are used.

**XXX 2602**

**Employability Skills, 15 class hours. (Offered as needed)**

This course will cover such topics as current job search techniques, skills identification, resume writing, interviewing skills, job retention skills and career exploration. Students will have Interests and Aptitudes assessed.

**XXX 2602J**

**APTICOM, 3 class hours. (Offered as needed)**

A computerized assessment tool which evaluates your aptitudes, interests and math and language abilities. The report will give you recommendations for career areas which you will generally have the highest degree of success.

**XXX 6923**

**Food Service Manager Seminar, 30 class hours, 3 c.e.u.'s (Offered as needed)**

Designed to update the food service manager in the areas of nutrition, merchandising, work simplifications, job descriptions and analysis, and human relations. Prerequisite: employment in school food service.

**XXX 7749**

**Basic Baking, 180 class hours, 18.0 c.e.u.'s (Offered as needed)**

A study of baking practices and principles as they apply to the preparation of breads, rolls, pastries, pies, cakes, cookies, and specialty desserts.

**XXX 7756**

**Sanitation/Safety for Food Service Workers, 30 class hours, 15 lec., 15 lab., 3 c.e.u.'s (Offered as needed)**

A course designed to develop a consciousness of safe and sanitary procedures in food serving to groups of people and to teach persons how to follow safe personal and operation habits in food service.



## COMMUNICATIONS

### CREDIT COURSES

**AML 2000**

**Survey of American Literature, 3 semester hours, 45 lec. (Fall, Spring, Summer)**

A survey course in American Literature from the Colonial period to the Civil War. This course may be used for Humanities credit.

**AML 2022**

**Survey of American Literature II, 3 semester hours, 45 lec. (Fall, Spring, Summer)**

A survey of American Literature from Civil War to present. This course may be used for Humanities credit.

**CRW 2000**

**Creative Writing I, 3 semester hours, 45 lec. (Offered as needed)**

Creativity in prose, poetry, and drama. All students creations are submitted to publishers.

**CRW 2002**

**Creative Writing II, 3 semester hours, 45 lec. (Offered as needed)**

The student writes in the following genres: prose, poetry, or drama. The student submits manuscripts to a publisher. Prerequisite: a beginning writing course, evidence of substantial publication, or equivalent.

**EDF 2905**

**Independent Study – Education, 1 semester hour. (Offered as needed)**

Directed experience in specific areas of education. Entry coordinated through department chair.

**ENC 0010\***

**College Preparatory English, Level I, 3 semester hours, 45 lec. (Fall, Spring, Summer)**

This course develops written language skills for students whose entry level placement scores fall below the minimum. Basic sentence structure and elementary grammatical concepts will be emphasized. Approximately one-third of instruction will be focused on composing coherent, well-structured sentences; one paragraph will be written at the end of the semester. Grammar instruction will be limited to understanding the parts of compound and complex sentences. At any point in the semester a student earning a C in the course may take an exit examination; a minimum score of 75% will allow the student to

\*College preparatory credits may not be counted toward fulfilling the number of credits required for a degree.

be eligible for ENC 0020 level 2; a student with this score who also demonstrates the skills necessary for the successful completion of level 2 may be eligible for a college-level communications course, depending upon his/her writing sample results.

**ENC 0020\***

**College Preparatory English, Level 2, 3 semester hours, 45 lec. (Fall, Spring, Summer)**

This course develops written language skills for students whose entry level placement scores fall below the minimum. Basic sentence and paragraph structure and grammatical concepts will be emphasized. Approximately one-third of instruction will be focused on composing coherent, well-structured paragraphs; at least one short essay (3 to 5 paragraphs) may be written at the end of the semester. Grammar instruction will focus on the parts of all sentences and basic usage and punctuation skills. At any point in the semester a student earning a C in the course may take an exit examination; a minimum score of 75% will allow him/her to enroll in a college-level communications course.

**ENC 1101**

**English Composition I, 3 semester hours, 45 lec. (Fall, Spring, Summer)**

Instruction and intensive practice in expository and argumentative writing, including research paper and interpretive reading of essays. Prerequisite: A passing score on a standardized test measuring communications/verbal achievement and a score of 3 on the writing sample or grade of C or better in LIN 1670.

**ENC 1102**

**English Composition II, 3 semester hours, 45 lec. (Fall, Spring, Summer)**

Interpretive and critical reading of fiction (novel, novella, short story), drama, and poetry. Practice in writing various types of essays and the library research paper. Prerequisite: completion of English Composition I or an equivalent course with a grade of C or better.

**ENC 1104**

**CLAST Review: Essay Skills, 1 semester hour, 15 lec. (Offered as needed)**

A short course specifically designed to prepare students to write fifty-minute timed essays that conform to CLAST standards.

**ENC 1105**

**CLAST Review: English Language Skills, 1 semester hour, 15 lec. (Offered as needed)**

A short course specifically designed to prepare students to take or retake the CLAST English Language Skills subtest.

**ENC 2210**

**Technical Report Writing, 3 semester hours, 45 lec. (Offered as needed)**

This course covers the fundamentals of technical report writing, mechanics, and style. Various types of reports are prepared, and criteria for evaluating the adequacy of the various components of these reports are utilized. The course also includes reading and analysis of technical literature as well as oral reporting.

**ENC 2313**

**Expository Writing, 3 semester hours, 45 lec. (Offered as needed)**

Review of fundamental principles of grammar and usage with guided practice in writing expository essays of a kind and quality expected in upper-level college work. Offers an alternative to the Test of Standard Written English as a means of satisfying the UWF Writing Skills Requirement.

**ENC 2940**

**Directed Work Study — Communications, 1 semester hour (Fall, Spring, Summer)**

Directed experience in instructional, laboratory and/or materials assistance in a designated communication area. Entry coordinated through the department chair.

**ENC 2941**

**Tutorial-Communications, 1 semester hour, 30 lab. (Fall, Spring, Summer)**

An experience in individual depth study in which one student prepares for and engages in tutoring another for two class periods per week.

**ENG 1001**

**Research Papers, 1 semester hour, 16 lab. (Fall, Spring, Summer)**

A learn-by-doing course in the methods of conducting library research and writing a documented paper. Students will work in the library on self-selected subjects under the supervision and guidance of the instructor in a tutorial relationship. For successful completion, each student will write a documented paper in accordance with a standard system. NOTE: If this course is used to satisfy writing requirements for transfer courses to OWCC, a minimum grade of "C" is required.

**ENG 2905**

**Independent Study-Literature, 1 semester hour (Offered as needed)**

A critical study and analysis of a specific literary figure or era. Offered and directed to meet the needs of students interested in such a specialization area. Entry coordinated through the department chair.

**ENL 2011**

**English Literature I, 3 semester hours, 45 lec. (Offered as needed)**

A study of English literature from the Old English period, Beowulf, through the late Eighteenth century, the Age of Enlightenment, focusing on major works and their authors with an emphasis upon the literature as a significant reflection of and contribution to the political, cultural, social, religious, and economic milieu of each age. This course may be used as a Humanities credit.

**ENL 2012**

**English Literature II, 3 semester hours, 45 lec. (Offered as needed)**

A study of English literature from the Romantics through the Twentieth century focusing on major works and their authors with an emphasis upon the literature as a significant reflection of and contribution to the political, cultural, social, religious, and economic milieu of each age. This course may be used as a Humanities credit.

\*College preparatory credits may not be counted toward fulfilling the number of credits required for a degree.

**ESL 0181**

**ESL Structure and Writing: Level II, 3 semester hours, 75 lec. (Offered as needed)**

This course will present English grammar in a meaningful sequence and will develop the writing skills of those students for whom English is not the native tongue. It is designed to prepare these students for entry into college level English courses by improving their control of standard English.

**FRE 1120**

**French I, 4 semester hours, 60 lec. (Fall and Summer Term I)**

Pronunciation and grammatical structures of French, with emphasis upon balanced development of all four skills — listening, speaking, reading, and writing. Covers all basic structures of the language. Students who have successfully completed two or three years of high school French should enroll in French III-IV.

**FRE 1121**

**French II, 4 semester hours, 60 lec. (Offered Spring and Summer Term II)**

Pronunciation and grammatical structures of French, with emphasis upon balanced development of all four skills — listening, speaking, reading and writing. Covers all basic structures of the language. Students who have successfully completed three years of high school French should enroll in French III-IV.

**FRE 2200**

**French III, 4 semester hours, 60 lec. (Offered Fall and Summer Term I)**

Intermediate level review of grammar, readings in French literature, and development of conversational and writing skills. Prerequisite: Two or three years of high school French with grade of "B" or better, or FRE 1120 and 1121 or its equivalent.

**FRE 2201**

**French IV, 4 semester hours, 60 lec. (Offered Fall and Summer Term II)**

Completion of intermediate level review of grammar, readings in French literature, and development of conversational and writing skills. Prerequisite: three years of high school French with grade of "B" or better, or FRE 2200 or its equivalent.

**FRW 2100**

**Introduction to French Literature I, 3 semester hours, 45 lec. (Offered as needed)**

The development of French literature from the middle ages to the end of the 18th century. Prerequisite: FRE 2201 or its equivalent.

**FRW 2101**

**Introduction to French Literature II, 3 semester hours, 45 lec. (Offered as needed)**

The development of French literature from the beginning of the 19th century to the present. Prerequisite: FRE 2201 or its equivalent.

**GER 1120**

**German I, 4 semester hours, 60 lec. (Fall)**

Functional development of understanding of spoken and written German, with emphasis upon balanced development of all four skills — listening, speaking, reading, and writing. The German I and II sequence covers all basic structures of the language. Students who have successfully completed two or three years of high school German should enroll in German III-IV.

**GER 1121**

**German II, 4 semester hours, 60 lec. (Spring)**

Functional development of understanding of spoken and written German, with emphasis upon balanced development of all four skills—listening, speaking, reading, and writing. Covers all basic structures of the language. Students who have successfully completed two or three years of high school German should enroll in German III-IV. Prerequisite: GER 1120 or equivalent.

**GER 2200**

**German III, 4 semester hours, 60 lec. (Fall)**

Intermediate level review of grammar, readings in contemporary literature and current affairs, audio-lingual practice, and development of conversational and writing skills. Prerequisite: GER 1120, GER 1121 or two years or more in high school German with a grade of "B" or better, or equivalent.

**GER 2201**

**German IV, 4 semester hours, 60 lec. (Spring)**

Completion of intermediate level review of grammar, readings in contemporary literature and current affairs, audio-lingual practice, and development of conversational and writing skills. Prerequisite: three years of high school German with grade of "B" or better, or GER 2200 or its equivalent.

**GER 2420**

**Advanced German Grammar and Composition I, 3 semester hours, 45 lec. (Offered Fall or when needed)**

Study of advanced grammatical structures, selected development of vocabulary and idiom, practice in oral and written composition. Prerequisite: GER 2201 or four years of high school German.

**GER 2421**

**Advanced German Grammar and Composition II, 3 semester hours, 45 lec. (Offered Spring or when needed)**

Study of advanced grammatical structures, selected development of vocabulary and idiom, practice in oral and written composition. Prerequisite: GER 2201 or four years of high school German.

**GER 2440**

**Business German (Wirtschaftsdeutsch), 3 semester hours, 45 lec. (Offered as needed)**

Business German will include readings from current German essays and news articles sampling all aspects of business writing. The student will practice forms of business communications: letters, advertising, forms for bills of lading, invoices, explanations of business procedures, etc. Prerequisite: Equivalent of German I, II, III, IV, mastery of intermediate level of German.

**GER 2905**

**Independent Study-German, 1 semester hour (Offered as needed)**

Directed study designed to meet needs of students interested in specific areas of German language and literature for which the present course offerings are limited.

**GEW 2010**

**Introduction to German Literature I, 3 semester hours, 45 lec. (Offered Fall or when needed)**

A survey of representative literary works from the early 17th century through the death of Goethe (1833).

**GEW 2011**

**Introduction to German Literature II, 3 semester hours, 45 lec. (Offered Spring or when needed)**

A survey of representative literary works from 1833 to the present, grouped by periods and literary movements.

**JOU 1100**

**Journalism I, 3 semester hours, 15 lec., 30 lab. (Offered as needed)**

Teaches the basics of straight news story writing, photography, copy preparation, editing, layout, and design of publications with an emphasis on newspapers and magazines. Prerequisite: High School English and typing preferable.

**JOU 1103**

**Journalism II, 3 semester hours, 15 lec., 30 lab. (Offered as needed)**

Introduces the student to the art of feature writing, including the basics of finding a good story idea, researching the periodicals market, sending query letters, and marketing the finished project. The course also teaches the mechanics of writing leads, building the body of the story and proper closing.

**LIN 1670**

**Writing and Grammar, 3 semester hours, 45 lec. (Fall, Spring, Summer)**

Course includes practice in writing sentences, paragraphs, and essays; comprehensive review of grammar; and introduction of effective rhetorical patterns. Placement is determined by a passing score on a standardized test measuring communications/verbal achievement and a score of 2 on the writing sample or a grade of C or better in ENC 0020 College Preparatory English, Level 2.

**LIS 1001**

**Using Library Resources, 1 semester hour, 30 lec. (Offered as needed)**

A course creating learning situations in which individual students can become effective independent users of the Learning Resources facilities.

**LIT 2090**

**Contemporary Literature, 3 semester hours, 45 lec. (Fall, Spring, or as needed)**

Studies in modern drama, prose, and poetry, focusing on their comments on modern man. May be used as Humanities credit.

**LIT 2100**

**World Literature, 3 semester hours, 45 lec. (Fall, Spring, Summer)**

Designed to encourage students to know and appreciate something of the great literature which helps to mold their thinking and everyday living. To include, without regard to national origin, those masterpieces of the Western World which reflect their cultural and intellectual heritage. May be used as a Humanities credit.

**ORI 2000**

**Oral Interpretation, 3 semester hours, 45 lec. (Offered as needed)**

Oral interpretation of all genres of literature. Students read and research appropriate literature to cut, adapt, and present to the class as solo, duet, and group interpretations.

**REA 0001\***

**College Prep Reading, 3 semester hours, 30 lec., 45 lab. (Fall, Spring, Summer)**

This course is designed for students whose entry level placement test scores do not meet state requirements. Conducted in a lecture/lab setting, this course is designed to improve reading speed, vocabulary, comprehension, and study skills. Also covered (at a basic level) are the skills that conform to CLAST standards. Activities and materials are individualized to meet specific needs of students as determined through diagnostic instruments. Course must be repeated by students not fulfilling competency requirements. However, state education rules limit students to three registrations in this course.

**REA 1605**

**Effective Study, 1 semester hour, 15 lec., 15 lab. (Offered as needed)**

Practical application of psychological principles to personal learning and study skills. Recommended for all students who feel deficient in study techniques or who otherwise wish to improve their study skills.

**REA 2105**

**Advanced Reading, 2 semester hours, 15 lec., 30 lab. (Fall, Spring, Summer)**

An individualized approach designed to improve reading speed, comprehension, and critical analysis skills while reading various types of material for either educational or recreational purposes. Activities and materials are individualized to meet specific needs of students as determined through diagnostic instruments. Also used as a preparation course covering (at a more critical level) the skills tested on the CLAST. Helpful for those students whose speed, comprehension, and analysis skills are weak or inadequate for proper text book analysis.

**REA 2305**

**Reading Skills Review, 1 semester, 15 lec. (Fall, Spring, Summer)**

A short course specifically designed to prepare students to take or retake the CLAST Reading Skills subtest. Through pre-testing, weak areas in CLAST skills are identified. These identified weak areas will be strengthened through drills, exercises, and/or other means.

**SLS 1101**

**Freshman Seminar, 1 semester hour, 10 lec., (Offered as needed)**

A seminar designed to orient entering students to OWCC, to familiarize them with the requirements of the College-Level Academic Skills Program, to assist them in assessing their academic competencies (i.e., identify strengths and weaknesses), to identify means for capitalizing on strengths and for overcoming weaknesses, and to enter and pursue academic specializations (majors) based on reasonable career choices. This course is required for all entering, fulltime, A.A. Degree seeking students in their first semester. Part-time students must take this course in the semester they are enrolled in their twelfth credit.

\* College preparatory credits may not be counted toward fulfilling the number of credits required for a degree.

**SLS 1301****Career and Life Planning, 1 semester hour, 15 lec., 15 lab. (Offered as needed)**

The course is designed to help students assess their values, competencies and goals in relation to the selection of careers and life-styles for which they are best suited. On a national average, two thirds of entering college freshmen have not made a choice concerning a career. Furthermore, extensive research shows that the student who has not made a career choice is much more likely to drop-out of college. This course will help students make an informed, realistic career choice which will form the basis for their life's work and which will also increase the probability of completing an academic program.

**SPC 1600****Speech, 3 semester hours, 45 lec. (Fall, Spring, Summer)**

Emphasis is on assisting the individual to develop his/her potential in oral communication. Individual participation in preparation and presentation of speeches reinforced by continuing group analysis and constructive criticism.

**SPC 2520****Discussion and Debate, 3 semester hours, 10 lec., 35 lab. (Offered as needed)**

This course is designed to provide learning experiences in rational decision making incorporating the techniques of persuasion through organized procedures for argumentation. "Debate and Discussion." Prerequisite: High school speech or College speech.

**SPN 1120****Spanish I, 4 semester hours, 60 lec. (Offered Fall, Spring, and Summer Term I)**

Pronunciation and grammatical structures of Spanish, with emphasis upon balanced development of all four skills — listening, speaking, reading, and writing. Covers all basic structures of the language. Students who have successfully completed two or three years of high school Spanish should enroll in Spanish III-IV.

**SPN 1121****Spanish II, 4 semester hours, 60 lec. (Spring and Summer Term II)**

Pronunciation and grammatical structure of Spanish, with emphasis upon balanced development of all four skills - listening, speaking, reading, and writing. Covers all basic structures of the language. Students who have successfully completed two or three years of high school Spanish should enroll in Spanish III-IV.

**SPN 2200****Spanish III, 4 semester hours, 60 lec. (Fall and Summer Term I)**

Intermediate level review of grammar, readings in Spanish literature, and development of conversational and writing skills. Prerequisite: Two or three years of high school Spanish with grade of "B" or better, or SPN 1120 and 1121 or its equivalent.

**SPN 2201****Spanish IV, 4 semester hours, 60 lec. (Spring and Summer Term II)**

Completion of intermediate level review of grammar, readings in Spanish literature, and development of conversational and writing skills. Prerequisite: two or three years of high school Spanish with a grade of "B" or better, or SPN 2200 or its equivalent.

**SPN 2300****Advanced Spanish Grammar and Composition I, 3 semester hours, 45 lec. (Offered as needed)**

Study of advanced grammatical structures and practice in composition. Prerequisite: SPN 2201 or its equivalent.

**SPN 2301****Advanced Spanish Grammar and Composition II, 3 semester hours, 45 lec. (Offered as needed)**

Study of advanced grammatical structure and practices in composition. Prerequisite: SPN 2201.

**SPW 2100****Introduction to Spanish Literature I, 3 semester hours, 45 lec. (Offered as needed)**

Selected readings in modern Spanish and Spanish-American literature. Prerequisite: SPN 2300.

**SPW 2101****Introduction to Spanish Literature II, 3 semester hours, 45 lec. (Offered as needed)**

Selected readings in modern Spanish and Spanish-American literatures. Prerequisite: SPN 2201.



For information on Continuing Education Units, see page 87.

**ESL 0080****Structure and Writing: Level I, non-credit, 45 contact hours. (Offered as needed)**

This course will present English grammar in a meaningful sequence and introduce students to writing as a process. It will focus on linking the systematic study of grammar with its use in written expression and oral communication.

**XXX 4602****(ESL) English as a Second Language, 45 to 90 class hours, 4.5 to 9 c.e.u.'s (Offered as needed)**

Group and individual instruction in English for adults. Emphasis is placed on speaking, reading, and writing English based on living experiences and needs.

**XXX 4631****Everyday German, 18 class hours, 1.8 c.e.u.'s (Offered as needed)**

Everyday German offers essential conversational phrases and sentences for tourists or military personnel. Greetings, travel, and money questions, shopping, sightseeing, using facilities of hotels and restaurants, dealing with medical or mechanical emergencies, learning basic terms used in one's special sport or hobby — these are the essentials presented in oral dialogues by a team of two instructors.



**CREDIT COURSES**

**CHD 1220**

**Child Growth and Development I, 3 semester hours, 45 lec. (Fall, Spring)**

Growth and development of the child from conception through age five, including the physical, social, emotional and mental development of the young child, influence of environment, principles and theories of development.

**CHD 1230**

**Child Growth and Development II, 3 semester hours, 45 lec. (Fall, Spring)**

Study of the physical, emotional, social, and intellectual growth and development of the school age child (6 through 12 years) up to preadolescence. Includes dynamics of behavior, child guidance and needs of exceptional children.

**CHD 1430**

**Observing and Recording Child Behavior, 3 semester hours, 30 lec., 45 lab. (Fall, Spring)**

Designed to increase objectivity and proficiency in observing and interpreting children's behavior; in addition, to increase awareness of normative patterns of children from birth through five years of age.

**CHD 1800**

**Early Childhood Program Administration, 3 semester hours, 45 lec. (Fall, Spring, Summer)**

This course provides the student with management and administrative skills related to child care services. Instruction includes: director responsibilities; staff selection, supervision, and evaluation; planning for budget, nutritional services, facility maintenance, health, and safety; and marketing techniques.

**CHD 1941\***

**Internship, Child Development, 3 semester hours, 90 lab. (Offered as needed)**

On-the-job training in Associate of Science degree, Associate degree/Applied Science Option, Certificate programs in which the student is enrolled. The student is under the supervision at work of a qualified supervisor appointed by the respective agency, who works with the OWCC instructor regarding student's OJT objectives based on student's goals and prior training. The supervisor will rate the student's performance, knowledge, comprehension, dependability, initiative, cooperativeness based on OJT performance. OWCC instructor will evaluate student OJT experience in consultation with agency supervisor regarding OJT performance and project paper on approved project submitted two weeks prior to close of semester. This course may be repeated four times for a total of 12 semester hours. Prerequisite: Must have completed a minimum of 9 hours credit in appropriate discipline.

**CHD 2130\***

**Orientation to CDA Credentialing, 1 semester hour, 15 lec., 5 lab (Offered as needed)**

A course including orientation to the Child Development Associate credentialing process; preassessment by means of written evaluation, skill test and observation of student's performance with young children; and development of student assessment plan.

**CHD 2322**

**Programs for Young Children, 3 semester hours, 45 lec. (Spring)**

Study of principles and practices of programs for young children; current research in early childhood education, role of the teacher, and selection and use of equipment and materials for groups of young children.

**CHD 2332A\***

**Curriculum for Young Children II, 3 semester hours, 15 lec., 60 lab. (Spring and as needed)**

Study of and development of effective skills and techniques used in program planning and use of creative media for young children.

**CHD 2334A\***

**Curriculum for Young Children III, 3 semester hours, 15 lec., 60 lab. (Spring and as needed)**

Study of the principles, methods, and materials used to assist young children acquire basic skills to use language effectively and competently; evaluation and development of appropriate teaching materials to use with young children.

**CHD 2337A\***

**Curriculum for Young Children IV, 3 semester hours, 15 lec., 60 lab. (Offered as needed)**

Study of the basic concepts, methods, and materials of mathematics, science, and social studies appropriate to the education of young children, identification of the role of staff members in the center for the education of young children; and overview of parent education.

**CHD 2432A**

**Curriculum for Young Children I, 3 semester hours, 15 lec., 60 lab. (Fall, Summer, Spring)**

Study of the techniques of using language arts, science, art, social studies, music, mathematics, and physical activities with young children. Participation in Child Development Education Center.

**CHD 2433\***

**Child Development Seminar, 3 semester hours, 45 lec. (Spring and as needed)**

Weekly seminar to critique performance and plan effective intern experience. Prerequisite: CHD 2332A, 2334A, or 2337A or equivalent.

**COA 2100**

**Consumer Education, 3 semester hours, 45 lec. (Fall, Spring, Summer)**

A study of the role of the consumer and consumer goods and services related to the home. The course will encourage wise planning and use of family resources.

\* Occupational course that may not be applied toward the A.A. Degree.

**CTE 1204****Wardrobe Imaging for Professionals, 3 semester hours, 45 lec. (Offered as needed)**

This course provides for the development of competency in planning individual and family wardrobes. Attention will be given to the effectiveness of clothing choices in professional situations. Factors to consider in purchasing wardrobe items are stressed as well as the care, maintenance and updating of various wardrobe components. Emphasis will be placed on the psychological and social factors influencing dress and the relationship of physical appearance to clothing selection.

**CTE 1310****Clothing Selection and Construction I, 3 semester hours, 30 lec., 30 lab. (Fall and as needed)**

A basic course in clothing construction stressing judgment in the selection and use of commercial patterns, development of skill and understanding of construction techniques and fitting. A consideration of art principles as related to clothing.

**CTE 1340****Clothing II, 3 semester hours, 30 lec., 30 lab. (Spring and as needed)**

Advanced problems and techniques of clothing construction and alterations. Prerequisite: CTE 1310 or equivalent.

**CTE 1401****Textiles, 3 semester hours, 45 lec. (Fall)**

The study of fabrics used in clothing and home furnishings with emphasis on fibers, yarns, construction procedures, designs, and finishes that determine the qualities, performance, and care of fabrics.

**CTE 2743****Creative Pattern Design, 3 credit hours, 30 lec., 30 lab. (Offered as needed)**

A course designed for students with prior experience in clothing construction who are interested in designing garments for themselves and others. Major concepts of the course include: (1) elements and principles of design and their application to fashion; (2) constructing a basic pattern (a sloper). A garment of original design will be constructed in a laboratory setting.

**FAD 1123****Adults in a Changing Society, 3 semester hours, 45 lec. (Fall, Spring, Summer)**

A course focusing on personal development and traditional or nontraditional career options available to adults in today's changing society.

**FAD 1230****Family Relationships, 3 semester hours, 45 lec. (Fall, Spring)**

This course provides basic information on family lifestyles, effect of self concept on marital selection, problems and adjustments of married couples, and use of personal and family resources to achieve more satisfying individual and family relationships.

**FSS 1210C****Family Meal Planning, 3 semester hours, 30 lec., 30 lab. (Offered as needed)**

A basic study of foods and principles underlying meal planning, food selection, preparation and service. A consideration of the essentials of an adequate diet.

**FSS 1292****Using Energy Saving Appliances in Cooking, 1 semester hour, 15 lec., 5 lab. (Offered as needed)**

The basic operation of the energy saving appliances and use in cooking techniques for various foods.

**HHD 1321****Basic Home Decorating, 1 semester hour, 15 lec. (Offered as needed)**

Basic study of home decorating principles and techniques; analyzing decorating needs and priorities; inexpensive ideas for creating individual and inviting atmosphere in the home through buying wisely, making needed items, or using existing home furnishings.

**HHD 2110****Home Planning and Furnishing, 3 semester hours, 45 lec. (Fall and as needed)**

A basic course in home planning, selection, use and care of equipment and furnishings for family living. Consideration of art principles in planning livable interiors, and current trends in housing.

**HME 1200****Home Management I, 1 semester hour, 15 lec. (Offered as needed)**

Basic course in managing the home as related to individual and family activities; includes principles of positive interaction of family members as well as time and energy management applied to housekeeping tasks of providing and maintaining food, shelter, and clothing, and good communication for family members.

**HOE 1010****Introduction to Home Economics, 3 semester hours, 45 lec. (Fall and as needed)**

Introduction to Home Economics as a career field of study; a consideration of history, professional opportunities, problems and current trends.

**HOE 2905****Independent Study-Home Economics, 1 semester hour, 30 lec., 30 lab. (Fall, Spring, Summer)**

Directed study in individual projects designed to meet the needs of students interested in specialized areas of Home Economics for which present course availability is limited. Areas of study can also supplement present Home Economics courses for special emphasis of depth. Recommendation by department chair.

**HOE 2906****Directed Work Study-Home Economics, 1 semester hour, 45 hours (Fall, Spring, Summer)**

Directed experience in instructional, laboratory and/or materials assistance in a designated Home Economics area. Entry by permission of department chair only.

**HOE 2907****Tutorial-Home Economics, 1 semester hour, 30 lec. (Fall, Spring, Summer)**

An experience in individual depth study in which one student prepares for and engages in tutoring one or more students for two class periods per week. The student will assist other students having remedial and specific needs (academic or laboratory) in a designated area in Home Economics. Recommendation by department chair.

**HUN 2410A****Child Nutrition and Health, 3 semester hours, 45 lec. (Offered as needed)**

Methods of meeting physical needs of young children through nutrition and good health practices. Recognition of childhood diseases and care of the handicapped child.

**HUS 1400A****Peer Advising, 3 semester hours, 15 lec., 60 lab. (Fall, Spring, Summer)**

A course in techniques of peer advising focusing on communication skills, professional ethics, and knowledge of community resources for referral purposes; to be used under professional supervision in human service agencies and organizations.

**SLS 1201****Community Service Seminar, 1 semester hour, 5 lec., 20 lab. (Offered as needed)**

A seminar course designed to enhance and reinforce the value of civic responsibility and to provide students with a community service program opportunity by volunteering in community agencies in the public and private sectors.



For information on Continuing Education Units, see page 87.

**HEV 0161****Early Childhood Program Administration, noncredit, 45 lec. hours (Fall, Spring)**

This course provides the student with management and administrative skills related to child care services. Instruction includes: director responsibilities; staff selection, supervision, and evaluation; planning for budget, nutritional services, facility maintenance, health, and safety; and marketing techniques.

**HEV 0213****Patternmaking, noncredit, 30 lec., 30 lab. hours (Offered as needed)**

A course designed for students with prior experience in clothing construction who are interested in designing garments for themselves and others. Major concepts of the course include: (1) elements and principles of design and their application to fashion and (2) constructing a basic pattern (a sloper). A garment of original design will be constructed in a laboratory setting.

**HEV 0216****Wardrobe Planning, noncredit, 45 lecture hours (Offered as needed)**

This course provides for the development of competency in planning individual and family wardrobes. Attention will be given to the effectiveness of clothing choices in professional situations. Factors to consider in purchasing wardrobe items are stressed as well as the care, maintenance and updating of various wardrobe components. Emphasis will be placed on the psychological and social factors influencing dress and the relationship of physical appearance to clothing selection.

**HEV 0311****Family Relationships, noncredit, 45 lec. hours (Fall, Spring)**

This course provides basic information on family lifestyles, effect of self concept on marital selection, problems and adjustments of married couples, and use of personal and family resources to achieve more satisfying individual and family relationships.

**XXX 6601****Educating the Consumer, 45 class hours, 4.5 c.e.u.'s (Fall, Spring, Summer)**

A study of the role of the consumer and consumer goods and services as related to the home. The course will encourage wise planning and use of resources.

**XXX 6610****Advising Peers, 60 class hours, 6.0 c.e.u.'s (Fall, Spring, Summer)**

A course in techniques of peer advising, focusing on communication skills, professional ethics, and knowledge of community resources for referral purposes; to be used under professional supervision in human service agencies and organizations.

**XXX 6621****Child Nutrition and Health Practices, 45 class hours, 4.5 c.e.u.'s (Offered as needed)**

Methods of meeting the physical needs of young children through nutrition and good health practices. Recognition of childhood diseases and care of the handicapped child.

**XXX 6624****Adjustment for Life, 45 class hours, 4.5 c.e.u.'s (Offered as needed)**

Application of psychological theory for problem solving and better mental health. A look at psychological defense mechanisms and how they may be changed into more adaptive behavior.

**XXX 6625****Managing the Home I, 15 class hours, 1.5 c.e.u.'s (Offered as needed)**

Basic course in managing the home as related to individual and family activities, includes principles of positive interaction of family members as well as time and energy management applied to housekeeping tasks of providing and maintaining food, shelter, clothing, and good communication for family members.

**XXX 6630****Cake Decorating, 14 class hours, 1.4 c.e.u.'s (Offered as needed)**

Designed to teach how to decorate a cake. (Self-supporting course).

**XXX 6641****Adults in Transition, 45 class hours, 4.5 c.e.u.'s (Fall, Spring, Summer)**

A course in which (1) participants will become aware of the special problems faced by persons in nontraditional fields with emphasis on overcoming occupational sex stereotyping and (2) participants will develop individualized career plans through the processes of realistic decision making and goal setting.

**XXX 6906**

**Basic Child Care and Guidance, 45 to 154 class hours, 4.5 to 15.4 c.e.u.'s (Offered as needed)**

The growth and development of the child from conception through age 5 including the physical, social, emotional, and intellectual development of the young child and the influences of environment, principles, and theories of development.

**XXX 6907**

**Consumer and Homemaking Education, 90 class hours, 9 c.e.u.'s (Fall, Spring, Summer)**

Designed to help students improve home environment and the quality of personal and family life and includes instruction in food and nutrition, child development, clothing, housing, family relations and management of resources.

**XXX 6911**

**Introduction to Basic Clothing Construction, 45 class hours, 4.5 c.e.u.'s (Offered as needed)**

Designed to develop skills in clothing selection and construction. Emphasis on management of individual resources to meet the need of family members.

**XXX 6913A**

**Curriculum for Young Children I, 105 class hours, 10.5 c.e.u.'s (Fall, Spring, Summer)**

Study of techniques of using language arts, science, art, social studies, music, math, and physical activities with young children with emphasis on interdisciplinary learning.

**XXX 6915A**

**Ways of Working With Young Children I, 75 class hours, 7.5 c.e.u.'s (Offered as needed)**

Course designed to increase objectivity and proficiency in observing, recording, and interpreting children's behavior; in addition, to increase awareness of patterns of behavior of children from 2 to 5 years. Includes child guidance and discipline techniques. Various assignments given as participant observes in child development centers or homes.

**XXX 6916**

**Parent Involvement, 60 class hours, 6 c.e.u.'s (Offered as needed)**

Study of effective ways of working with parents, understanding home and community setting. Prerequisite: XXX 6913A and XXX 6915A preferable, or equivalent.

**XXX 6917**

**Constructing Creative Equipment and Material, 60 class hours, 6 c.e.u.'s (Offered as needed)**

Selecting, making and using indoor and outdoor equipment and teaching materials with young children; approximately one half focusing on language development. Prerequisite: XXX 6906, XXX 6913A and XXX 6915A preferable.

**XXX 6918**

**Child Care Services, 45 class hours, 4.5 lec., 4.5 c.e.u.'s (Offered as needed)**

Study of programs for young children with emphasis on the teaching roles, selection and use of equipment and materials for groups of young children.

**XXX 6920**

**Programs for School-Age Children, 45 class hours, 4.5 c.e.u.'s (Spring and as needed)**

Emphasis on programming for after-school care; includes understanding needs of school age child up to 12 years.

**XXX 6922**

**Ways of Working with Young Children II, 90 class hours, 9 c.e.u.'s (Offered as needed)**

Study of development and application of effective skills and techniques used in programming for young children. Prerequisite: XXX 6906, XXX 6913A, XXX 6915A preferable.

**XXX 6925**

**Basic Tailoring, 75 class hours, 7.5 c.e.u.'s (Offered as needed)**

Tailoring principles, traditional and shortcut methods in fitting, construction, and finishing tailored garment. Use of wool fabric, underlining and interfacing such as hair canvas and asnaburg will be used. Advanced techniques of welt pockets, bound buttonholes, metered vent, padding stitches, and shoulder pads are also included.

**XXX 6929**

**Decorating Your Home I, 15 class hours, 1.5 c.e.u.'s (Offered as needed)**

Basic study of home decorating principles and techniques; analyzing decorating needs and priorities; inexpensive ideas for creating individual and inviting atmosphere in the home through buying wisely or making needed items, or using existing home furnishings.

**XXX 6932**

**Child Care Seminar, 45 class hours, 4.5 c.e.u.'s (Offered as needed)**

Weekly seminar to critique performance and plan effective student field experience. Individual and group conferences scheduled concurrently with field experience.

**XXX 6935**

**Advanced Clothing Construction, 75 class hours, 7.5 c.e.u.'s (Offered as needed)**

Advanced problems and techniques of clothing construction and creative expression.

**XXX 6938**

**Improving Quality of Family Life, 20 class hours, 2 c.e.u.'s (Offered as needed)**

A course which focuses on improving the quality of personal and family life through instruction in child development, family relations, budgeting and managing resources, and homemaking skills with emphasis on the dual role (home and job).

**XXX 6939**

**Cooking with Energy Saving Appliances, 20 class hours, 2 c.e.u.'s (Offered as needed)**

The basic operation of energy saving appliances and use in cooking techniques for various foods.



## HUMANITIES, FINE & PERFORMING ARTS

### CREDIT COURSES

**ARH 1000**

**Humanities Art, 3 semester hours, 45 lec. (Offered as needed)**

Basic concepts of art, including formal analysis and the sociology and psychology of style. Does not fulfill Art History requirement for art majors.

**ARH 2050****Art History: Prehistoric-Renaissance, 3 semester hours, 45 lec. (Fall, or as needed)**

A survey of significant contributions in art, architecture and the crafts from prehistoric times through the Renaissance period.

**ARH 2051****Art History: Renaissance-20th Century, 3 semester hours, 45 lec. (Spring, or as needed)**

A survey of significant contributions in art architecture and the crafts from the Renaissance period to recent Twentieth Century works.

**ART 1110C****Pottery I, 3 semester hours, 15 lec., 60 lab. (Offered as needed)**

The students shall be exposed to the production of pottery utilizing all known hand building techniques. Also includes introduction to potter's wheel and basic wheel fundamentals. First half of course is hand building, second half is devoted to development of skills on the potter's wheel. Students also learn how to glaze pottery and make glass.

**ART 1111C****Pottery II, 3 semester hours, 15 lec., 60 lab. (Offered as needed)**

Continues hand building of Pottery I, but major emphasis is placed upon development skills utilizing the potter's wheel. Additional glazing experimentation is also emphasized. Prerequisite: ART 1110C.

**ART 1201C****Two-Dimensional Design, 3 semester hours, 15 lec., 60 lab. (Offered as needed)**

Principles of visual organization. Deals with line, space, form and color in two-dimensional composition.

**ART 1203C****Three-Dimensional Design, 3 semester hours, 15 lec., 60 lab. (Offered as needed)**

Extension and development of the elements of design in three dimensional projects.

**ART 1230C****Graphic/Commercial Design I, 3 semester hours, 30 lec., 30 lab. (Offered as needed)**

A comprehensive introduction, overview and practical experience relating to the basic fundamentals, techniques, procedures, principles and tools used in graphic/commercial art.

**ART 1300C****Drawing I, 3 semester hours, 15 lec., 60 lab. (Offered as needed)**

Problems in drawing techniques and media.

**ART 1301C****Drawing II, 3 semester hours, 15 lec., 60 lab. (Offered as needed)**

Problems in drawing and composition. Prerequisite: ART 1300C or equivalent.

**ART 1430C****Screen Printing I, 3 semester hours, 30 lec., 30 lab. (Offered as needed)**

Classroom and lab experiences pertaining to the designing, film positive preparation, stencil preparation, and printing of two-color screen printed textiles.

**ART 1431C****Screen Printing II, 3 semester hours, 30 lec., 30 lab. (Offered as needed)**

Classroom and lab experiences pertaining to the preparation and production of four-color, close registered stencils for textile printing. (A continuation of Screen Printing I).

**ART 1701C****Sculpture I, 3 semester hours, 15 lec., 60 lab. (Offered as needed)**

An introductory course in the techniques and aesthetic considerations of creating sculptural forms. Includes a wide range of possible materials and expressions, those used in the past and those being used currently, in both the reductive and additive methods. Students will be expected to solve problems in several different media that best expresses their particular sensibilities.

**ART 1702C****Sculpture II, 3 semester hours, 15 lec., 60 lab. (Offered as needed)**

A course in the creation of ceramic sculpture forms. Includes a wide range of possibilities in the use of ceramic materials to produce nonutilitarian forms. (It is expected that the student have a basic knowledge of clay and glazes as a prerequisite.)

**ART 1905****Independent Study - Art, 1 credit hour (Offered as needed)**

A defined independent study which is pursued under supervision of a faculty directing teacher and recorded through departmental procedures. Designed to permit a student to pursue nonscheduled academic and laboratory work which may be of a specialized or advanced nature and not available through classes or courses available on a college schedule. Departmental approval required.

**ART 2231C****Graphic/Commercial Design II, 3 semester hours, 30 lec., 30 lab. (Offered as needed)**

Comprehensive overview and practical experience relating to advanced procedures and specialized areas of interest in the graphic/commercial art field.

**ART 2270****Projects in Graphics/Commercial Design, 3 semester hours, 30 lec., 30 lab. (Offered as needed)**

Comprehensive introduction, overview and practical experience relating to the fundamentals and techniques of graphic/commercial art studio procedures, design and production.

**ART 2280C****Typography, 3 semester hours, 30 lec., 30 lab. (Offered as needed)**

A comprehensive introduction, overview and practical application relating to the principles of design and the use of letter forms. Stresses the feeling and visual impact in the design and use of different lettering styles. Prerequisites: ART 1300C, ART 1201C.

**ART 2510C****Painting I, 3 semester hours, 15 lec., 60 lab. (Offered as needed)**

Problems of constructing a composition in color. The academic methods of painting and student experimentation.

**ART 2520C**

**Painting II, 3 semester hours, 15 lec., 60 lab. (Offered as needed)**

Technique is stressed as an end result of approach to subject matter, development of abstraction through the use of theory. Prerequisite: ART 2510C or equivalent.

**ART 2560C**

**Water Color I, 3 semester hours, 15 lec., 60 lab. (Offered as needed)**

Problems of constructing a composition in color. The academic methods of watercolor painting and student experimentation.

**ART 2561C**

**Water Color II, 3 semester hours, 15 lec., 60 lab. (Offered as needed)**

Problems of constructing a composition in color. The academic methods of watercolor painting and student experimentation. A continuation of Water Color I. Prerequisite: ART 2560C.

**ART 2900**

**Independent Study – Graphic Art, 1 semester hour, 30 lab. (Offered as needed)**

Practical treatment of Graphics/Printing Technology within the field of offset printing. Emphasis on individual work projects utilizing such areas as copy preparation, darkroom work, stripping and platemaking, press operations, and bindery operations.

**ART 2955**

**Portfolio Development, 3 semester hours, 15 lec., 60 lab. (Offered as needed)**

Development of a working portfolio through studio project aimed at fulfilling the general requirements the average company, university, art school or advertising agency looks for in a portfolio presentation.

**HUM 1020**

**Humanities-Introduction, 3 semester hours, 45 lec. (Offered as needed)**

Techniques, forms, and basic evaluative tools related to music, the visual arts, poetry, drama, the dance, film, and philosophy. Art works are utilized as much as possible with examples relating to contemporary culture.

**HUM 1905**

**Independent Study – Arts and Humanities, 1 semester hour, 45 hours (Offered as needed)**

A defined independent study which is pursued under supervision of a faculty directing teacher and recorded through departmental procedures. Designed to permit a student to pursue nonscheduled academic and laboratory work which may be of a specialized or advanced nature and not available through classes or courses available on a college schedule. The student must obtain proper department approval prior to commencing the independent study.

NOTE: With written approval from the Fine Arts Division Director, this course may be used to satisfy writing requirements for transfer courses to OWCC; the student will write a documented paper in accordance with a standard system and must earn a minimum grade of "C."

**HUM 2700**

**Humanities – Foreign Study, 3 semester hours, 15 lec., 60 lab. (Offered as needed)**

A variable humanities content course designed to allow students first-hand learning experiences outside the United States.

**HUM 2905**

**Directed Work Study – Art Humanities, 1 semester hour, 45 hours (Offered as needed)**

Directed experience in instructional, laboratory and/or materials assistance in a designated Arts-Humanities area.

**HUM 2906**

**Tutorial – Arts and Humanities, 1 semester hour, 30 lab. (Offered as needed)**

An experience in individual depth study in which one student prepares for and engages in tutoring another for two class periods per week.

**MUH 1011**

**Humanities – Music, 3 semester hours, 45 lec. (Offered as needed)**

Designed to develop a more intelligent understanding and appreciation of music. Brings about an awareness of music as a vital source in human life, including the advantageous utilization of leisure time and developing positive attitudes toward culture and the fine arts.

**MUN 1000**

**Summer Ensemble Workshop, 3 semester hours, 15 lec., 60 lab. (Summer)**

An ensemble workshop open to any student who desires to improve vocal and physical presentation skills. A variety of musical physical styles will be studied and performed. Students participating in Summer Ensemble Workshop will be expected to participate in several scheduled performances. Prerequisite: Previous experience/departmental approval.

**MUN 1001**

**Summer Ensemble Workshop II, 3 semester hours, 15 lec., 60 lab. (Summer)**

An ensemble workshop open to any student who desires to improve vocal and physical presentation skills. A variety of musical physical styles will be studied.

**MUN 1002**

**Summer Ensemble Workshop III, 3 semester hours, 15 lec., 60 lab. (Summer)**

An ensemble workshop open to any student who desires to improve vocal and physical presentation skills. A variety of musical physical styles will be studied. Students participating in Summer Ensemble Workshop will be expected to participate in several scheduled performances. Prerequisite: MUN 1001.

**MUN 1180**

**OWCC Band (Community), 1 semester hour, 30 lab. (Offered as needed)**

A music organization providing an outlet and learning experience for both college students and wind or percussion players to read and perform standard band literature, transcriptions and program selections. Required of all wind or percussion music majors and minors. May be taken four times for credit. Prerequisite: Ability to read music and play a band instrument; audition by Director or 1 year experience in a high school advanced band. This course may be taken up to four (4) times for credit.

**MUN 1210****OWCC Symphony Orchestra I, 1 semester hour, 45 lab. (Fall, Spring)**

A music organization providing an outlet and learning experience to study and perform standard orchestra literature, to improve individual instrumental skills, and to sharpen ensemble techniques. The Symphony occasionally performs with guest artists, choral groups and theatre ensembles. This course may be taken four (4) times for credit.

**MUN 1310****OWCC Chorus, 1 semester hour, 30 lab. (Offered as needed)**

A music organization open through auditions to any student having experience in reading music. A variety of musical styles will be studied and performed. Students elective OWCC Chorus will be expected to participate in scheduled performances. MUN 1310 may be taken three times for credit. Prerequisite: Experience in high school, church, or community chorus or choirs. This course may be taken up to four (4) times for credit.

**MUN 1340A****OWCC Show Choir I, 1 semester hour, 45 lab. (Offered as needed)**

A study of the fundamental techniques and principles of integrating dance, voice, music and acting into a performance show choir. Training in voice, jazz movement, character interpretation and personality presentation is covered. Membership is open to all part-time or fulltime students on a credit or audit basis. All music majors and performance majors must participate. The show choir appears in public performances at frequent intervals throughout the year. Prerequisite: Audition, consent of Department, music or performance minor. This course may be taken four (4) times for credit.

**MUN 1710A****Rock and Jazz Ensembles I, 1 semester hour, 45 lab. (Offered as needed)**

Music performing organization open to any student who wants to develop his or her performance repertoire. Laboratory studies include techniques of performing music, literature, practices, styles and media applicable to designated organized ensemble. May be taken four times for credit. Prerequisite: Some experience in high school bands, etc. This course may be taken up to four (4) times for credit.

**MUN 1720A****Rock and Jazz Ensembles II, 1 semester hour, 45 lab. (Offered as needed)**

Music performing organization open to any student who wants to develop his/her performance repertoire. Laboratory studies include techniques of performing music, literature, practices, styles and media applicable to designated organized ensemble. Prerequisite: Some experience in high school bands, etc. This course may be taken up to four (4) times for credit.

**MUN 2120****OWCC Band (Community), 1 semester hour, 30 lab. (Offered as needed)**

A music organization providing an outlet and learning experience for both college students and wind or percussion players to read and perform standard band literature, transcriptions and program selections. Required of all wind or percussion music majors and minors. This course may be taken four times for credit. Prerequisite: MUN 1180.

**MUN 2211****OWCC Symphony Orchestra II, 1 semester hour, 45 lab. (Offered as needed)**

A music organization providing an outlet and learning experience to study and perform standard orchestra literature, to improve individual instrumental skills, and to sharpen ensemble techniques. The Symphony occasionally performs with guest artists, choral groups and theatre ensembles. This course may be taken four (4) times for credit.

**MUN 2371****OWCC Show Choir II, 1 semester hour, 45 lab. (Offered as needed)**

A study of the fundamental techniques and principles of integrating dance, voice, music and acting into a performance show choir. Training in voice, jazz movement, character interpretation and personality presentation is covered. Membership is open to all part-time or fulltime students on a credit or audit basis. All music majors and performance majors must participate. The show choir appears in public performances at frequent intervals throughout the year. Prerequisite: Show Choir I. This course may be taken four (4) times for credit.

**MUS 1905****Independent Study - Music, 1 semester hour (Offered as needed)**

A defined independent study which is pursued under supervision of a faculty directing teacher and recorded through departmental procedures. Designed to permit a student to pursue non-scheduled academic and laboratory work which may be of a specialized or advanced nature and not available through classes or courses available on a college schedule. Departmental approval required.

**MUT 1001****Fundamentals of Music, 3 semester hours, 45 lec. (Offered as needed)**

A pre-theory course for the nonmusic major, the music major who wishes to refresh his fundamental skills, or for the elementary education major. Included are the studies of reading clefs, rhythm, notation, scales, and doing simple keyboard and sight-singing exercises. The emphasis is on developing music reading skills.

**MUT 1121****Music Theory I, 3 semester hours, 30 lec., 15 lab. (Offered as needed)**

A study of the fundamentals of basic musicianship, music notation, understanding of simple rhythms, key situations, intervals, ear training, dictation, sight-singing, major and minor scales, intervals, triads, chords, polyphonic composition and elementary keyboard work. Prerequisite: Students wishing to take Music Theory I should have a strong background in music (high school chorus, bands, etc.).

**MUT 1122****Music Theory II, 3 semester hours, 30 lec., 15 lab. (Offered as needed)**

A continuation of Music Theory I, MUT 1121. Basic musicianship, writing and reading of music, ear training, dictation, sight-singing will be studied, as well as major and minor scales, intervals, triads, seventh chords, inversions, cadences, periods and progressions in all keys. Two, three and four part chords and polyphonic composition. Prerequisite: MUT 1121.

**MUT 2126****Music Theory III, 3 semester hours, 45 lec. (Offered as needed)**

A continuation of Music Theory I and II, MUT 1121 and MUT 1122. The harmonization and modulation of melodies through the use of nondominant harmony and the study of sequence writing. Incorporates keyboard harmony plus sight reading of chromatic melodies, large intervals, and advanced rhythms. Prerequisites: MUT 1121 and MUT 1122.

**MUT 2127****Music Theory IV, 3 semester hours, 45 lec. (Offered as needed)**

The continued study of harmonization of melodies, sequence writing, sight reading, intervals, advanced rhythms and structures. Prerequisites: MUT 1121, 1122, 2126.

**MUT 2351****Introduction to Jazz Theory/Arranging, 3 semester hours, 45 lec. (Offered as needed)**

A lecture-demonstration-workshop approach to jazz-pop arranging. Studies include jazz/pop harmonies, arranging fundamentals and techniques, and the use of jazz/pop instrumentation. Workshop practices include assigned arrangements with the arrangements played by the jazz ensemble, and other audio demonstrations. Prerequisite: MUT 1121 and 1122 or equivalent.

**MVB 1201****Applied Music Secondary-Brass, 1 semester hour, 7.5 lab. (Offered as needed)**

Private instruction: 1/2 hour private lesson per week. Minimum one hour daily practice. For nonmusic majors and music majors. Minimum of one hour daily practice is required. Course may be taken four (4) times for credit. Prerequisite: Private instruction or high school experience.

**MVB 2202****Applied Music Secondary-Brass II, 1 semester hour, 7.5 lab. (Offered as needed)**

Private instruction: 1/2 hour private lesson per week. Minimum one hour daily practice. For nonmusic majors and music majors. Minimum of one hour daily practice is required. Course may be taken four (4) times for credit. Prerequisite: MVB 1201.

**MVK 1211****Applied Music-Plano I, 1 semester hour, 7.5 lab. (Offered as needed)**

Private instruction in piano, as secondary instrument, consisting of one half-hour lesson per week. Minimum of one hour daily practice is required. Course may be taken four (4) times for credit.

**MVK 2221****Applied Music-Plano II, 1 semester hour, 7.5 lab. (Offered as needed)**

Private instruction in piano, as a secondary instrument, consisting of one half-hour lesson per week. Minimum of one hour daily practice is required. Course may be taken four (4) times for credit.

**MVP 1201****Applied Music Secondary-Percussion, 1 semester hour, 7.5 lab. (Offered as needed)**

Private instruction in percussion instruments to develop the student's performance ability in an applied

area. One half-hour private lesson per week. Minimum of one hour daily practice. Minimum of one hour daily practice is required. Course may be taken four (4) times for credit.

**MVP 2202****Applied Music Secondary-Percussion II, 1 semester hour, 7.5 lab. (Offered as needed)**

Private instruction in percussion instruments to develop the student's performance ability in an applied area. One half-hour private lesson per week. Minimum of one hour daily practice. Minimum of one hour daily practice is required. Course may be repeated four (4) times for credit. Prerequisite: MVP 1201.

**MVS 1111****Class Guitar, 1 semester hour, 15 lec. (Fall)**

The study of basic techniques for the beginning and continuing student.

**MVS 1201****Applied Music Secondary-Strings, 1 semester hour, 7.5 lab. (Offered as needed)**

Private instruction: one half-hour private lesson per week. Minimum one hour daily practice. For non-music majors and music majors. Minimum of one hour daily practice is required. Course may be taken four (4) times for credit.

**MVS 2202****Applied Music Secondary-Strings II, 1 semester hour, 7.5 lab. (Offered as needed)**

Private instruction: one half-hour private lesson per week. Minimum one hour daily practice. For non-music majors and music majors. Minimum of one hour daily practice is required. Course may be taken four (4) times for credit.

**MVV 1211****Applied Music-Voice I, 1 semester hour, 7.5 lab. (Offered as needed)**

Private instruction in voice, as a secondary instrument, consisting of one half-hour session per week, with a minimum of one hour daily practice. Minimum of one hour daily practice is required. Course may be taken four times for credit.

**MVV 2221****Applied Music-Voice II, 1 semester hour, 7.5 lab. (Offered as needed)**

Private instruction in voice, as a secondary instrument, consisting of one half-hour lesson per week, with a minimum of one hour daily practice. Minimum of one hour daily practice is required. Course may be taken four (4) times for credit.

**MVW 1201****Applied Music Secondary-Woodwinds, 1 semester hour, 7.5 lab. (Offered as needed)**

Private instruction: one half-hour private lesson per week. Minimum one hour daily practice. For non-music majors and music majors. Minimum of one hour daily practice is required. Course may be taken four (4) times for credit.

**MVW 2202****Applied Music Secondary-Woodwinds II, 1 semester hour, 7.5 lab. (Offered as needed)**

Private instruction: one half-hour private lesson per week. Minimum one hour daily practice. For non-music majors and music majors. Minimum of one hour daily practice is required. Course may be taken four (4) times for credit. Prerequisite: MVW 1201.



**PGY 1101C****Basic Photography, 2 semester hours, 25 lec., 30 lab. (Offered as needed)**

An elective course for students of graphics/printing program, and others having vocational, avocational, hobby or fine arts interests in photography. Course content will cover fundamentals, basic principles, film processing/developing, picture composition, lighting, exposure, special techniques, and mounting of prints. Camera, enlarger, light meter, flood lights and other photographic equipment will be covered.

**PGY 1103C****Advanced Black & White Photography, 3 semester hours, 30 lec., 30 lab. (Fall, Spring, Summer)**

This course covers an overview of composition and "impact" photography. Studio photography will be conducted as well as available light, solarization photography, and photo essay. All subject matter will be presented in a lecture format followed by student field activities and darkroom film processing and enlarging. Students must have their own 35 mm camera and supporting equipment.

**PHI 2010****Humanities-Philosophy, 3 semester hours, 45 lec. (Offered as needed)**

Central concepts of philosophy are developed, including a description of the main philosophical problems involved through ancient, medieval, and contemporary thought.

**PHI 2600****Humanities Ethics, 3 semester hours, 45 lec. (Offered as needed)**

Central concepts of Ethics are developed. Philosophical theories from Aristotelian-Thomism to Existentialism and Phenomenology are presented in moral argumentative form.

**REL 2300****Humanities-Comparative Religion, 3 semester hours, 45 lec. (Offered as needed)**

Principal religions of the world are compared and contrasted. Christianity is examined in its historical and contemporary forms.

**THE 1905****Independent Study-Theatre, 1 semester hour (Offered as needed)**

A defined independent study which is pursued under supervision of a faculty directing teacher and recorded through departmental procedures. Designed to permit a student to pursue nonscheduled academic and laboratory work which may be of a specialized or advanced nature and not available through classes or courses available on a college schedule. Departmental approval required.

**THE 2000****Humanities-Theatre, 3 semester hours, 45 lec. (Offered as needed)**

An introduction to theatre and theatrical production. Topics span a wide range of interest — critical, historical, aesthetic and practical — intended to lay a foundation for further knowledge and skill of the theatre.

**THE 2080****Amateur Theatre, 3 semester hours, 30 lec., 30 lab. (Offered as needed)**

To establish a guideline for students of the theatre who may become active in community theatres; and for teachers in secondary schools who may be assigned the task to direct plays. This course is designed to find practical solutions to these contemporary producing groups. Prerequisites: THE 2000, TTP 2110 and TTP 2111.

**THE 2071****Humanities — Cinema Appreciation, 3 semester hours, 45 lec. (Offered as needed)**

An introduction to the origin, development, cultural aspects and analysis of cinema topics.

**THE 2320****Introduction to Creative Dramatics, 3 semester hours, 15 lec., 60 lab. (Offered as needed)**

An introduction to creative dramatics and children's theatre. Topics span a wide range of interests; creative experience, children and theatre, workshop procedure, script selection, rehearsal and performance. Traveling to local elementary schools will be a part of the creative drama experience.

**TPA 1200****Technical Theatre Lab I, 3 semester hours, 15 lec., 60 lab. (Offered as needed)**

An introduction to technical theatre and scene technology. Topics include scene drawings, safety and health, stage facility, basic crafts, two and three dimensional scenery, scene painting, scene assembly, rigging, properties, special effects and shop organization.

**TPA 2220****Technical Theatre Lab II, 3 semester hours, 15 lec., 60 lab. (Offered as needed)**

An introduction to stage lighting. Topics include history of stage lighting, fundamentals of light and illumination, lighting control, and lighting practices.

**TPA 2230****Introduction to Costuming Technology, 3 semester hours, 15 lec., 60 lab. (Offered as needed)**

An introduction to costume techniques and wardrobe practices. Topics span a wide range: costume construction techniques, problems in costumes, costume history, construction styles, sewing machine practices, seam finishes, flat pattern layout and production techniques. This course is intended to develop practical experiences in theatre costumes.

**TTP 2110****Acting I, 3 semester hours, 30 lec., 30 lab. (Offered as needed)**

Through in-class performance the student will develop an understanding and proficiency of those skills of movement, voice, and expression which are required of a theatrical performer.

**TTP 2111****Acting II, 3 semester hours, 30 lec., 30 lab. (Offered as needed)**

A continued refinement of basic acting techniques introduced in TTP 2110. Through in-class performance, the student develops an understanding and proficiency in styles of acting from classic through modern.

## HUMANITIES, FINE & PERFORMING ARTS

### NONCREDIT COURSES (C.E.U.)

For information on Continuing Education Units, see page 87.

**XXX 3614**

**Photography, 20 class hours, 2 c.e.u.'s (Offered as needed)**

Fundamentals of photography. Exploratory experiences for the student having vocational, avocational, hobby or fine arts interest in photography. (A) Basic principles of photography, (B) film processing and developing techniques, (C) composition, lighting, mounting and special applications. May be repeated. Student should provide own camera.

## MANUFACTURING & TECHNOLOGY

### CREDIT COURSES

**ACR 1000\***

**Principles of Air Conditioning, 6 semester hours, 75 lec., 105 lab. (Offered as needed)**

Beginning course in air conditioning and refrigeration with emphasis on basic fundamentals, safety, measuring tools, hand and power tools, soldering and brazing, blueprints, and basic mathematics.

**ACR 1100\***

**Electrical Theory for Air Conditioning, 6 semester hours, 75 lec., 105 lab. (Offered as needed)**

A study of alternating current, electrical theories and practices as they apply to air conditioning, study of Ohm's law, basic and advanced circuitry, switches and controls.

**ACR 2060\***

**Air Conditioning, Heating and Refrigeration, 6 semester hours, 75 lec., 105 lab. (Offered as needed)**

A continuation of air conditioning and heating practices with special emphasis on heat/load calculations, duct sizing, and psychrometric properties of air.

**ACR 2303\***

**Electrical Controls for Air Conditioning and Refrigeration, 6 semester hours, 75 lec., 105 lab. (Offered as needed)**

A course designed to prepare the student to diagnose and correct malfunctioning which may occur in air conditioning and refrigeration units. Prerequisite: ACR 1100.

**ACR 2600\***

**Principles of Gas, Electrical, and Solar Heating, 6 semester hours, 75 lec., 105 lab. (Offered as needed)**

A course designed to prepare the student to acquire a working knowledge of gas, electrical, and solar heating systems. Prerequisites: ACR 1100.

**ACR 2745\***

**Commercial Refrigeration and Air Conditioning, 6 semester hours, 75 lec., 105 lab. (Offered as needed)**

A course designed to prepare the student to become familiar with commercial refrigeration and air conditioning systems, to properly size, install and/or service these systems and components. Prerequisites: ACR 1100.

**ACR 2810\***

**Environmental Control Systems for Buildings, 3 semester hours, 15 lec., 60 lab. (Offered as needed)**

A course designed to further prepare a trained/experienced serviceman in the concept, theory, installation, operation and troubleshooting of pneumatic and electronic automatic control systems to regulate pressure, temperature, humidity, or rate and volume of flow to establish and maintain the indoor environment of a building or structure.

**AER 1120\***

**Auto Suspension, Steering & Brakes, 6 semester hours, 30 lec., 150 lab. (Offered as needed)**

A course in the fundamentals of diagnosing and repairing automotive malfunctions in the area of suspension, steering, and brakes. Includes lecture, demonstration, practical application activities and performance tests.

**AER 1142\***

**Fuel, Lube and Cooling Systems, 6 semester hours, 30 lec., 150 lab. (Offered as needed)**

A course in the fundamentals of diagnosing and repairing automotive malfunctions in automotive fuel, lubrication, and cooling systems. Includes lectures, demonstrations, practice application activities, and performance testing.

**AER 2103\***

**Automotive Electrical Systems, 6 semester hours, 30 lec., 150 lab. (Offered as needed)**

A course in the fundamentals of diagnosing and repairing malfunctions to automotive electrical systems. Includes lecture, demonstration, practical application activities, and performance testing.

**AER 2112\***

**Automotive Engines, 6 semester hours, 30 lec., 150 lab. (Offered as needed)**

A course in the fundamentals of diagnostics and repairing automotive malfunctions in the area of automotive engines. Includes lecture, demonstrations, practical application activities, and performance testing.

**AER 2112A\***

**Automotive Engines, 2 semester hours, 15 lec., 45 lab. (Offered as needed)**

This is the first in a series of three courses that will cover the fundamentals of diagnostics and automotive engine malfunctions. Includes lecture, demonstrations, practical application activities, and performance testing.

**AER 2112B\***

**Automotive Engines II, 2 semester hours, 15 lec., 45 lab. (Offered as needed)**

This is the second in a series of three courses that will cover the fundamentals of diagnostics and repairing automotive engine malfunctions. Includes lecture, demonstrations, practical application activities, and performance testing.

\*Occupational course that may not be applied toward the A.A. Degree.

**AER 2112C\*****Automotive Engines III, 2 semester hours, 15 lec., 45 lab. (Offered as needed)**

This is the third in a series of three courses that will cover the fundamentals of diagnostics and repairing automotive engine malfunctions. Includes lecture, demonstrations, practical application activities, and performance testing.

**AER 2131\*****Transmission, 6 semester hours, 30 lec., 150 lab. (Offered as needed)**

Study and practical experience covering the clutch, standard transmission, automatic transmission, drive line, and differential.

**AER 2171\*****Automotive Air Conditioning, 6 semester hours, 75 lec., 105 lab. (Offered as needed)**

A course designed to prepare a student to diagnose, service and repair automotive air conditioning systems.

**AMT 1000\*****Aviation General, 4 semester hours, 60 lec. (Offered as needed)**

A course designed to prepare beginning students for careers in aviation mechanics, and/or help elective students broaden their knowledge and skills in this area. Covers all of the topics dealt with on the Aviation General portion of the FM licensing exam.

**AMT 1140\*****Aircraft Welding, 3 semester hours, 15 lec., 45 lab. (Offered as needed)**

Shop safety precautions and procedures; practical and theoretical training in the use of oxyacetylene, arc, and Tig welding, in general aviation; training in the recognition of various materials for welding and in the selection of the proper welding materials and equipment for use in general aviation.

**AMT 1811\*****Air Frame Mechanics I, 4 semester hours, 60 lec. (Offered as needed)**

A course to prepare aircraft frame mechanics for the airframe portion of the FM licensing examination. Covers such topics as: fabrics, finishes, wood members, and sheetmetal. F.A.R. 65.77 must be complied with before student will be permitted to take FM examination. Prerequisite: AMT 1000.

**AMT 1812\*****Air Frame Mechanics II, 4 semester hours, 60 lec. (Offered as needed)**

A course to prepare aircraft frame mechanics for the airframe portion of the FM licensing examination. Covers such topics as: hydraulic systems for brakes, rigging for mechanical controls, electrical systems, weights and balance. F.A.R. 65.77 must be complied with before students will be permitted to take FM examination. Prerequisite: AMT 1000.

**AMT 1821\*****Air Power Plant Mechanics I, 4 semester hours, 60 lec. (Offered as needed)**

A course to prepare aircraft power mechanics for the power plant portion of the FAA licensing examination. Covers such topics as: fuel systems, electrical systems, and engine repair/overhaul. F.A.R. 65.77 must be complied with before student will be permitted to take FAA examination. Prerequisite: AMT 1000.

**AMT 1822\*****Air Power Plant Mechanics II, 4 semester hours, 60 lec. (Offered as needed)**

A course to prepare aircraft power mechanics for the power plant portion of the FM licensing examination. Covers such topics as: oil pressure, weights and balances, propellers, and a continuation of engine repair/overhaul. F.A.R. 65.77 must be complied with before student will be permitted to take FM examination. Prerequisite: AMT 1000.

**ART 1282C****\*Graphic Process, 4 semester hours, 30 lec., 60 lab. (Offered as needed)**

Comprehensive overview and practical experience relating to fundamentals, techniques, procedures, and tools used in the preparation of copy for offset printing.

**ART 1420C\*****Lithography I, 4 semester hours, 30 lec., 60 lab. (Offered as needed)**

This course will provide a comprehensive study of and practical experience in the area of process camera work, stripping techniques, proofing methods and offset platemaking.

**ART 1421C\*****Lithography II, 4 semester hours, 30 lec., 60 lab. (Offered as needed)**

This course is a continuation of Lithography I, with more advanced techniques and processes included, such as: halftones, duotones, posterizations, and the use of Color-Key for proofing. Prerequisite: ART 1420C.

**ART 1480C\*****Computer Art, 3 semester hours, 30 lec., 60 lab. (Offered as needed)**

A basic course in how the computer can be adapted and used in the visual arts. Creative uses of the computer with various software and hardware will introduce the student to Fine Art and Graphic Arts applications using a B/W monitor and printer.

**ART 1481C\*****Computer Graphic Design I, 4 semester hours, 30 lec., 60 lab. (Offered as needed)**

Classroom and lab experiences pertaining to the uses and applications of a computer, scanner, and laser printer combination for "desktop publishing." The class will also cover various software programs to generate, compose, display, and edit images electronically.

**BCN 1230\*****Building Construction Materials and Processes, 3 semester hours, 45 lec. (Offered as needed)**

Course designed to introduce the student to terminology, methods, procedures, materials, and processes used in the construction industry.

**BCN 1272\*****Blueprint Reading for Commercial Construction, 3 semester hours, 45 lec. (Offered as needed)**

A course to familiarize non-drafting students with techniques of blueprint reading and the fundamentals of construction methods that make blueprint reading meaningful.

\*Occupational course that may not be applied toward the A.A. Degree.

**BCN 1520\*****Electrical Systems in Construction, 3 credits, 45 hours. (Offered as needed)**

A course to familiarize students with electrical terminology, practices, methods, code requirements and safety and health in construction.

**BCN 1567\*****Plumbing and Gas Construction Practices, 3 credits, 45 hours (Offered as needed)**

A course to familiarize students with Plumbing and Gas code requirements, terminology, methods, practices, processes and safety and health used in building construction.

**BCN 1708\*****Construction Documentation, 3 semester hours, 45 lec. (Offered as needed)**

A course to familiarize a student with documents used in the Construction Industry to advertise for bids, contracts, change orders, extras, specification, insurance and bid bonds.

**BCN 2475\*****Structural Systems in Construction, 3 credits, 45 hours (Offered as needed)**

A course to familiarize students with Structural terminology, practices, methods, code requirements and safety and health criteria in construction.

**BCN 2560\*****Mechanical Systems in Construction, 3 credits, 45 hours (Offered as needed)**

A course to familiarize students with mechanical trades terminology, methods, practices, code requirements processes, and safety and health criteria in mechanical construction.

**BCN 2610\*****Construction Estimating, 3 credits, 45 hours (Offered as needed)**

A course in estimating as it relates to the construction industry. Material covered includes references, estimating methods, take-off organization and presentation, material take-off and cost estimating in heavy construction. Pre/corequisite: BCN 1272.

**BCN 2721\*****Construction Management Planning, 3 credit hours, 45 lec. (Offered as needed)**

The course covers the development and organization of projects, preconstruction site investigation, planning, scheduling, estimating. The course will also include control of costs, operations and resources together with cost engineering, procurement, value engineering, quality assurance, safety and health in construction.

**CET 1251\*****Basic Computer Operation and Maintenance for Technology, 3 semester hours, 30 lec., 30 lab. (Offered as needed)**

Basic course covering the operation of the IBM and IBM compatible personal computer. Topics covered include: fundamental DOS commands, basic computer maintenance covering hard and floppy disc drives, plug-in cards, cables, monitors, and printers. Information on upgrading techniques will cover memory upgrades, installation of disc drives and mother boards.

**CET 2114C\*****Digital Fundamentals I, 5 semester hours, 30 lec., 135 lab. (Offered as needed)**

Studies include coding, decoding, logic gates, DeMorgan's T heorem, boolean algebra and Karnaugh Map simplification, logic families, flip-flops, counters, shift registers, ALU multiplexers, demultiplexers, PLA, A/D and D/A converters.

**CET 2123C\*****Microprocessor Fundamentals, 5 semester hours, 30 lec., 135 lab. (Offered as needed)**

This course covers the architecture, instruction set, and programming of a common microprocessor. Subjects covered will include programming, input/output, and troubleshooting. The student will use logic and signature analysis in order to find instructor inserted faults. Assembly language programming and writing of algorithms will be introduced. Prerequisite: CET 2114C or equivalent.

**CET 2152C\*****Computer/Analysis & Troubleshooting, 5 semester hours, 30 lec., 135 lab. (Offered as needed)**

This course will expand on the knowledge gained in Digital Technology II. Three units of instruction covering troubleshooting, input/output, and memories will be covered. A more advanced level of digital system troubleshooting will be introduced. Prerequisite: CET 2123C or equivalent.

**CET 2311C\*****Computer Assisted Circuit Analysis, 4 semester hours, 30 lec., 60 lab. (Offered as needed)**

This course is designed to reinforce the student's knowledge of the laws, theorems, and concepts of electronics and their applications in network analysis. It also introduces BASIC language programming and the use of the computer in generating instantaneous, error free results. The time normally taken with laboratory work will be utilized in writing and testing BASIC language programs for circuit analysis. Prerequisite: EET 1015C and EET 1025C or equivalent.

**EET 1003\*****Electronics for Drafters, 3 semester hours, 30 lec., 30 lab. (Offered as needed)**

An introductory course in electronics for drafters, designers, and beginning electronics technicians; designed to provide a basic understanding of electronic principles, theories and concepts.

**EET 1015C\*****Basic Electricity/Electronics I, 5 semester hours, 30 lec., 135 lab. (Offered as needed)**

The first course of the program introduces the electron theory, the theory, analysis, and troubleshooting of series, parallel and series parallel DC resistive circuits, network theorems, DC meters, magnetism, and electromagnetic induction. Laboratory safety is emphasized and extensive practice is given in the use of the VOM and electric voltmeter.

\*Occupational course that may not be applied toward the A.A. Degree.

**EET 1025C\*****Electricity/Electronics II, 5 semester hours, 30 lec., 135 lab. (Offered as needed)**

The second course introduces alternating current and the circuit properties of inductance and capacitance. Subjects covered are inductors, capacitors, the theory and analysis of resistance-inductance, resistance-capacitance, resistance-inductance-capacitance, and resonant circuits, filters and complex notation in alternating current circuits. Laboratory safety will continue to be emphasized and extensive practice given in use of the oscilloscope. Prerequisite: EGT 1015C or equivalent.

**EET 1141C\*****Devices and Circuits I, 5 semester hours, 30 lec., 135 lab. (Offered as needed)**

Introduces semiconductor and PN junction theory. Circuits and devices covered are the junction diode, diode circuits, power supplies, bipolar junction transistor, transistor biasing, transistor circuits, FETs, and operational amplifiers. All circuits presented are built and tested in the laboratory. Prerequisite: EET 1025C or equivalent.

**EET 1142C\*****Devices and Circuits II, 5 semester hours, 30 lec., 135 lab. (Offered as needed)**

Continue the study of devices and circuits to include thyristors, power amplifiers, oscillators, transducers and actuators, optoelectronics, and an introduction to electronic communications. Prerequisite: EET 1141C or equivalent.

**EET 1606C\*****Soldering/PC Board Techniques, 2 semester hours, 15 lec., 30 lab. (Offered as needed)**

Courses teaches the knowledge and skills required in high reliability soldering. The student will work with and practice maintenance of quality soldering stations. Practice will be provided in non-destructive soldering and desoldering of discrete and integrated circuits using printed circuit cards.

**EET 2215C\*****Electronic Instrumentation, 5 semester hours, 30 lec., 135 lab. (Offered as needed)**

This course covers the science of electronic measurements including terminology, errors, accuracy and tolerance, units, and standards. In addition, measurement methods and problems are covered. Test equipment theory, design, maintenance, are covered including DC meters, AC meters, analog, digital, strip recorders, AC and DC bridges, transducers oscilloscopes and probes, waveform generators and analyzers, fiber optic measurements, logic analyzers and complete instrumentation systems including ATE. Prerequisite: Completion of electronics core or equivalent.

**EET 2322C\*****Electronic Communications, 5 semester hours, 30 lec., 135 lab. (Offered as needed)**

This course covers telecommunication technology to include modulation (amplitude, angle and pulse) single-sideband, AM and FM receivers, time division multiplex, digital communication, antennas, transmission lines, waveguides, laser communication and basic radar. Prerequisite: Completion of electronics core or equivalent.

**EGS 1110C****Engineering Graphics, 3 semester hours, 30 lec., 30 lab. (Offered as needed)**

Use of instruments, lettering practice; geometric construction; multiview projection and conventions, auxiliary views, section views, axonometric and oblique projections, rotation, patterns and development, and methods of reproduction.

**EGS 1130C****Descriptive Geometry, 3 semester hours, 30 lec., 30 lab. (Offered as needed)**

Basic principles of orthographic projection, auxiliary views and rotation as they apply to points, lines and planes in space; addition of coplanar and non-coplanar vectors; intersections and developments; and selected abstract, exonomic and oblique projection, and practical problems. Prerequisite: EGS 1110C or equivalent.

**ETD 1100\*****Introduction to Technical Drawing, 3 semester hours, 30 lec., 30 lab. (Offered as needed)**

A course in the fundamental principles of the graphic language (the language of industry) and is developed for students without previous mechanical drawing experience. Topics include: use and care of instruments, lettering, geometric construction, multiview projection, sketching techniques, inking, and methods of reproduction.

**ETD 1111\*****Drafting I, 6 semester hours, 30 lec., 120 lab. (Offered as needed)**

The first of a sequence of courses in drafting which includes basic use of instruments, freehand lettering, geometric construction, orthographic projection, sections and conventions, conventional revolutions, dimensioning, inking, mechanical lettering, and methods of reproduction. Prerequisite: ETD 1100 or equivalent.

**ETD 1221\*****Drafting II, 6 semester hours, 30 lec., 120 lab. (Offered as needed)**

A course that continues and completes the student's study of the fundamentals intrinsic to all types of drafting. Topics covered include isometric, dimetric, trimetric, oblique, and perspective projection, auxiliary views, related mathematics, precision dimensioning and inking practices. Prerequisite: ETD 1111 or equivalent.

**ETD 1310\*****Intro. Computer Drafting, 3 semester hours, 30 lec., 30 lab. (Offered as needed)**

A course designed to help drafting students develop knowledge and skills in the area of computer aided drafting. The course will include general background information on computer drafting theory as well as presentations on state-of-the-art computer drafting hardware. Prerequisite: ETD 1111 or EGS 1110C or equivalent.

\*Occupational course that may not be applied toward the A.A. Degree.

**ETD 1311\*****Computer/Systems Drafting, 3 semester hours, 30 lec., 30 lab. (Offered as needed)**

A course designed to help students develop knowledge and skills in the areas of computer aided drafting and systems drafting. Topics covered include: computer aided drafting terminology; computer drafting hardware, software, and users; computer drafting hardware, software, and users; computer drafting applications; scissors drafting; reprographics; pin-registered overlay drafting; and team drafting. Prerequisite: ETD 1310 or equivalent.

**ETD 1320\*****Introduction to 3 Dimensional Modeling, 3 semester hours, 30 lec., 30 lab. (Offered as needed)**

A basic course in mechanical design using basic computer geometry techniques. Topics will include: orthographic projections, space relationships of points, lines, planes and revolution of objects. Additional coverage will include principles of surface generation, intersections, wire modeling, and solid modeling techniques. Prerequisite: ETD 1311 or equivalent.

**ETD 1614\*****Electromechanical Drafting, 3 semester hours, 30 lec., 30 lab. (Offered as needed)**

A course in the fundamentals of electronics drafting covering such topics as: using electronic symbols, schematic diagrams, connection diagrams, block and logic diagrams, WW board drawings, chassis drawings, and pictorial drawings. Prerequisite: ETD 1653 or equivalent.

**ETD 1653\*****PCB Drafting, 3 semester hours, 15 lec., 60 lab. (Offered as needed)**

A course to teach students principles of printed circuit board design, layout, and tape-on. Topics covered include: schematics logic, single side boards, multi-layer boards, art-masters, fabrication drawings, and silkscreen masters. Prerequisite: ETD 1310 or equivalent.

**ETD 1654\*****Intermediate Printed Circuit Board Drafting, 3 semester hours, 15 lec., 60 lab. (Offered as needed)**

A course to teach students principles of printed design and documentation through the use of a computer.

**ETD 1700\*****Drafting III, 6 semester hours, 30 lec., 120 lab. (Offered as needed)**

A course in the fundamentals of Mechanical and Machine Drafting. Topics covered include: Geometric dimensioning and true positional tolerancing; threads, nuts, bolts, screws, gears, cams and springs, drafting standards, and preparation of working drawings. Prerequisite: ETD 1111, ETD 1221, and ETD 2218 or equivalent.

**ETD 1710\*****Basic Machine Drafting, 3 semester hours, 45 lec. (Offered as needed)**

A course designed to help students develop the basic fundamentals of dimensioning and tolerancing. Topics include: dimensioning systems such as; metric, decimal, fractional-inch, foot and inch, tolerancing methods, limits and tolerances, tolerancing accumulation, dimensioning practices, and standards fits.

**ETD 1801\*****Technical Illustration, 3 semester hours, 15 lec., 45 lab. (Offered as needed)**

The purpose of this course is to help students develop the skills, knowledge, and attitudes necessary to be job entry-level qualified as technical illustrators. Prerequisites: ETD 1111 or EGS 1110C and ETD 1221 or equivalent.

**ETD 2011\*****Industrial Print Reading, 1 semester hour. (Offered as needed)**

The beginning level aspects of reading industrial prints such as drawing notes, title blocks, revision blocks, legends, schedules, multiviews, and parts list.

**ETD 2218\*****Geometric Dimensioning & Tolerancing, 3 semester hours, 30 lec., 30 lab. (Offered as needed)**

An introductory course in geometric dimensioning and tolerancing using the geometric method nationally accepted according to ANSIV14.5M. Topics covered include: definition and terms, symbols, datum referencing, locational tolerancing, form tolerancing, profile tolerancing, orientation and runout tolerancing, and math for positional tolerancing. Prerequisite: ETD 1710 or equivalent.

**ETD 2219\*****Advanced Geometric Dimensioning & Tolerancing, 3 semester hours, 30 lec., 30 lab. (Offered as needed)**

An advanced course in geometric dimensioning and tolerancing using the geometric method nationally accepted according to ANSIV14.5M. Topics covered include: definitions and terms, symbols, datum referencing, locational tolerancing, form tolerancing, profile tolerancing, orientation and runout tolerancing, math for positional tolerancing, quality assurance methods and techniques, and manufacturing methods and techniques. Prerequisite: ETD 2218 or equivalent.

**ETD 2351\*****Advanced Computer/System Drafting, 3 semester hours, 30 lec./30 lab hours. (Offered as needed)**

An advanced course designed to help students develop proficiency in the area of computer aided drafting and systems drafting. Topics covered include: transfer drawings, digitized drawings, explanatory drawings, multiview projections, exploded assemblies, pictorial drawings, auxiliary views, sections, details, geometric dimensioning and tolerancing, and CADD concepts. Prerequisites: ETD 1311 or equivalent.

**ETD 2355\*****3D Modeling, 3 semester hours, 30 lec./30 lab hours. (Fall, Spring)**

An advanced course in mechanical design using advanced computer techniques. Contents will include: 3D concepts, wire modeling, surface generation techniques, and solid modeling techniques. Prerequisite: ETD 1320 or equivalent.

**ETD 2534\*****Construction Drafting, 6 semester hours, 30 lec., 120 lab. (Offered as needed)**

A course to prepare students to develop shop drawings for large construction projects. Topics covered include: steel, precast concrete, prestressed concrete, poured-in-place concrete, and heavy timber construction projects. Prerequisites: EGS 1110C or ETD 1111 or equivalent.

\*Occupational course that may not be applied toward the A.A. Degree.

**ETD 2542\*****Structural Drafting, 3 semester hours, 15 lec., 60 lab. (Offered as needed)**

A course in the fundamentals of structural drafting including: an overview of structural drafting, prestressed concrete drafting, structural steel drafting, and poured on-site concrete drafting. Prerequisite: TAR 2121C or equivalent.

**ETD 2543C\*****Structural Drafting II, 3 semester hours, 15 lec., 60 lab. (Offered as needed)**

An advanced course in structural drafting covering prestressed concrete drafting, structural steel drafting, and poured-on-site concrete drafting for large commercial and industrial buildings as well as bridges, parking decks, towers, and stadiums. Prerequisite: ETD 2542 or equivalent.

**ETD 2655\*****Advanced Printed Circuit Board Drafting, 3 semester hours, 15 lec., 60 lab. (Offered as needed)**

A course to teach students advanced principles of printed design and documentation through the use of a computer. Prerequisites: ETD 1654 or equivalent.

**ETD 2705\*****Advanced Mechanical Drafting, 3 semester hours, 15 lec., 60 lab hours. (Offered as needed)**

An advanced course covering mechanical drafting, machine design, advanced dimensioning and tolerancing, and working drawings according to DOD and ANSI standards. Prerequisites: ETD 1700, ETD 2218, or equivalent.

**ETD 2905\*****Independent Study – Drafting, 1 semester hour (Fall, Spring, Summer)**

Practical treatment of special geometry, graphics, and design. Emphasis on individual work projects utilizing such graphical techniques as orthographic projection, perspective drawing, auxiliary views, topographic drawing, and graphing. Prerequisite: EGS 1110C or equivalent.

**ETG 1110\*****Electronics Computations, 4 semester hours, 60 lec. (Offered as needed)**

This course is designed to provide practical application of computations relating directly to electronics. It provides active, intensive application of basic mathematical theories and formulas to the analysis and solution of real world electronics problems. Prerequisite: MAT 1033 or equivalent.

**ETG 1941\*****Internship I – Technical Education, 3 semester hours, 225 lab hours (Offered as needed)**

On-the-job training in the Associate of Science Degree or Associate of Science/Applied Science Option degree program in which the student is actively enrolled. The student works under a qualified supervision on a job related to his/her degree program. The supervisor will rate the student's performance, knowledge, comprehension, dependability, initiative, cooperativeness, and total performance. A project paper or approved project will be submitted by the student two weeks prior to the end of the semester.

**ETG 1942\*****Internship II – Technical Education, 3 semester hours, 225 lab hours (Offered as needed)**

On-the-job training in the Associate of Science Degree or Associate of Science/Applied Science Option degree program in which the student is actively enrolled. The student works under a qualified supervisor on a job related to his/her degree program. The supervisor will rate the student's performance, knowledge, comprehension, dependability, initiative, cooperativeness, and total performance. A project paper or approved project will be submitted by the student two weeks prior to the end of the semester. On the job experience is built upon experiences gained through course ETG 1941.

**ETG 1943\*****Internship III – Technical Education, 3 semester hours, 225 lab hours (Offered as needed)**

On-the-job training in the Associate of Science Degree or Associate of Science/Applied Science Option degree program in which the student is actively enrolled. The student works under a qualified supervisor on a job related to his/her degree program. The supervisor will rate the student's performance, knowledge, comprehension, dependability, initiative, cooperativeness, and total performance. A project paper or approved project will be submitted by the student two weeks prior to the end of the semester. On the job experience is built upon experiences gained through this course ETG 1942.

**ETG 1944\*****Internship IV – Technical Education, 3 semester hours, 225 lab hours (Offered as needed)**

On-the-job training in the Associate of Science Degree or Associate of Science/Applied Science Option degree program in which the student is actively enrolled. The student works under a qualified supervisor on a job related to his/her degree program. The supervisor will rate the student's performance, knowledge, comprehension, dependability, initiative, cooperativeness, and total performance. A project paper or approved project will be submitted by the student two weeks prior to the end of the semester. On the job experience is built upon experiences gained through course ETG 1943.

**ETG 2905\*****Independent Study – Electronics, 1 semester hour (Fall, Spring, Summer)**

Directed study and individual projects designed to meet the needs of students interested in a specialized area of electronics for which present course availability is limited.

**ETI 1411\*****Advanced Manufacturing Processes, 3 semester hours, 45 lec. (Offered as needed)**

This course presents the numeric and computer numeric control of various machining processes and the use of computer programming in the machine shop. Included are shop safety, program preparation, milling, drilling, subroutines, coordinate systems and other related topics.

\*Occupational course that may not be applied toward the A.A. Degree.

**ETI 2110\*****Quality Control I, 3 semester hours, 45 lec. (Offered as needed)**

This is a comprehensive course designed to increase the student's knowledge and skill in all aspects of quality control. The course provides a variety of the basic skills that contribute to the outgoing quality in the mechanical trades. Included are quality functions, quality personnel, shop mathematics, understanding blueprints, measuring tools, their use and other related topics.

**ETI 2111\*****Quality Control II, 3 semester hours, 45 lec. (Offered as needed)**

An introductory course which examines the principles and practices of Total Quality Management (TQM) in our changing society. Focuses on the concepts of quality, customer satisfaction, continuous improvement, leadership, and teamwork in all aspects of American enterprise. Emphasizes planning and the integration of people and processes into a leadership dynamic of change to a total quality culture.

**ETI 2906\*****Tutorial-Industrial-Technical, 1 semester hour (Offered as needed)**

A program which awards credit recognition to outstanding students who volunteer to assist or tutor other students having remedial and specific academic or laboratory needs in a designated subject. Student tutors are recommended by faculty teaching a designated course and are supervised through the Counseling Office.

**ETI 2940\*****Directed Work Study-Industrial-Technical, 1 semester hour, 45 lab. (Fall, Spring, Summer)**

Directed experience in instructional, laboratory and/or materials assistance in a designated industrial-technical area.

**GRA 1530C\*****Typography, 3 semester hours, 30 lec., 30 lab. (Offered as needed)**

A comprehensive introduction, overview and practical application relating to the principles of design and the use of letter forms. Stresses the feeling and visual impact in the design and use of different lettering styles. Prerequisites: ART 1300C, ART 1201C or equivalent.

**GRA 1541C\*****Introduction to Copy Preparation, 4 semester hours, 30 lec., 60 lab. (Offered as needed)**

Comprehensive overview and practical experiences relating to fundamentals, techniques, procedures and tools used in the preparation of copy for offset printing.

**GRA 1543C\*****Graphic/Commercial Design I, 3 semester hours, 30 lec., 30 lab. (Offered as needed)**

A comprehensive introduction, overview and practical experience relating to the basic fundamentals, techniques, procedures, principles, and tools used in graphic/commercial art. Prerequisites: ART 1300C, ART 1201C or equivalent.

**GRA 1571C\*****Process Camera I, 4 semester hours, 30 lec., 60 lab. (Offered as needed)**

This course will provide a comprehensive study of and practical experience in the areas of: process camera work, stripping techniques, proofing methods and offset platemaking.

**GRA 1573C\*****Process Camera II, 4 semester hours, 30 lec., 60 lab. (Offered as needed)**

This course is a continuation of Process Camera I, with advanced techniques and processes included, such as: halftone, duotones, and the use of Color-Key for proofing. Prerequisite: GRA 1571C or equivalent.

**GRA 1601C\*****Fake Color Assembly, 3 semester hours, 30 lec., 30 lab. (Offered as needed)**

This course will provide comprehensive experience in the advanced film assembly technique of mechanical color separation, known as "Fake Color." Prerequisites: GRA 1571C, GRA 1573C or equivalent.

**GRA 1636C\*****Small Offset Press Operations, 4 semester hours, 30 lec., 60 lab. (Offered as needed)**

Comprehensive study of, and practical experience on a small sheet-fed offset press. Course includes press make-ready, operation adjustments, and maintenance.

**GRA 1820C\*****Desktop Publishing I, 3 semester hours, 30 lec., 30 lab. (Offered as needed)**

Publishing on a Macintosh desktop computer. This is a beginning level course designed to acquaint students with various software programs. Student will learn to produce flyers, ads, posters, newsletters, and other printed materials.

**GRA 1821C\*****Desktop Publishing II, 3 semester hours, 30 lec., 30 lab. (Offered as needed)**

An advanced course in the use of the Macintosh desktop computer. Software programs such as Page-Maker, Quark Express, and Freehand are utilized, along with a scanner in a more advanced application. Prerequisite: GRA 1820C or equivalent.

**GRA 2544C\*****Graphic/Commercial Design II, 3 semester hours, 30 lec., 30 lab. (Offered as needed)**

Comprehensive overview and practical experience relating to advanced procedures and specialized areas of interest in the graphic/commercial art field. Prerequisites: ART 1300C, ART 1201C or equivalent.

**GRA 2547C\*****Projects In Graphic Design, 3 semester hours, 30 lec., 30 lab (Offered as needed)**

Comprehensive introduction, overview and practical experience relating to the fundamentals and techniques of graphic/commercial art studio procedures, design and production. Prerequisites: ART 1300C, ART 1201C, GRA 1543C, GRA 2544C or equivalent.

**GRA 2635C\*****Offset Presswork I, 4 semester hours, 30 lec., 60 lab. (Offered as needed)**

This course provides practical experience of production printing done on a small offset press and the various finishing operations that a job might require before it is completed. Prerequisite: GRA 1636C or equivalent.

\*Occupational course that may not be applied toward the A.A. Degree.



**GRA 2800C****Computer Graphics I, 4 semester hours, 30 lec., 60 lab. (Offered as needed)**

This course provides instruction and practical exercises in the use of graphics software to create and generate color graphics to produce illustrations and charts on a Macintosh desktop publishing system. Prerequisites: GRA 1820C and GRA 1821C or equivalent.

**GRA 2905\*****Independent Study-Graphics/Printing, 1 semester hour, 45 lab. (Offered as needed)**

Practical treatment of graphics/printing technology within the field of offset printing. Emphasis on individual work projects utilizing such areas as copy preparation, darkroom work stripping and platemaking, press operation, and bindery operation. This course may be taken up to two times for credit.

**GRA 2949\*****Directed Work Study-Graphics/Printing, 1 semester hour, 45 lab. (Offered as needed)**

Directed experience in instructional, laboratory and/or materials assistance in a designed graphics/printing area. This course may be taken up to two times for credit.

**PMT 1106\*****Welding I, 3 semester hours, 15 lec., 45 lab. (Offered as needed)**

An introduction course including an overview of welding as an occupation, welding terminologies, fundamentals of shielded metal arc welding, and oxyacetylene welding and cutting. Practical experience will be gained in shielded metal arc welding and oxyacetylene welding and cutting.

**PMT 1111\*****Oxy-Fuel Welding, 6 semester hours, 30 lec., 150 lab. (Offered as needed)**

A course in the fundamentals of gas welding including: welding terminologies, oxyacetylene welding and cutting procedures. Practical experience will be gained in oxyacetylene welding of various joints configurations in the flat, horizontal, vertical and overhead positions. Extensive use of the oxyacetylene cutting process is an integral aspect of this course.

**PMT 1112\*****Advanced Oxy-Fuel Welding, 6 semester hours, 30 lec., 150 lab. (Offered as needed)**

An advanced gas welding and cutting course including: fusion welding in all positions, braze welding, cutting torch operation, gas welding of aluminum, stainless, stainless steel and cast measuring principles will be covered.

**PMT 1121\*****Arc Welding I, 6 semester hours, 30 lec., 150 lab. (Offered as needed)**

A course in the fundamentals of arc welding including; the operation and set up of the arc welding machine, selection and identification of electrode classifications, and an overview of the steel making process. Practical experience will be gained in arc welding of basic joint configurations using a variety of welding electrodes.

**PMT 1131\*****Tig Welding, 6 semester hours, 30 lec., 150 lab. (Offered as needed)**

A course in the fundamentals of Tig welding including: the set up and adjustment of the tig welding machine, selection of proper tungsten electrodes, selection of filler metals, and the use of various shielding gases. Practical experience will be gained in tig welding basic welded joints on stainless and mild carbon steel aluminum sheet and casting, and magnesium castings.

**PMT 1157\*****Specialty Welding, 6 semester hours, 30 lec., 150 lab. (Offered as needed)**

This course is for students in their final semester of the AS, AAS option and the Occupational Certificate welding programs. This course will cover the fundamentals of mig welding, lay-out work, fabrication, and repair type welding. The student will have the opportunity to fine tune their gas, arc, tig, and oxyacetylene cutting skills before entering the job market. This course will also cover job seeking techniques such as: application forms, resume writing, and interview procedures.

**PMT 1161\*****Pipe Welding, 6 semester hours, 30 lec., 150 lab. (Offered as needed)**

A course in the fundamentals of pipe welding including: pipe welding terminologies, oxyacetylene welding and brazing of small diameter pipe, shielded metal arc welding of large diameter pipe. Extensive use of the oxyacetylene cutting process for pipe beveling is an integral aspect of this course.

**PMT 1175\*****Pipe Fitting, 6 semester hours, 30 lec., 150 lab. (Offered as needed)**

A course covering the fit up and welding of all common pipe configurations such as: branches, laterals, headers, reducers and orange peel pipe caps. Extensive use of the shielded metal arc welding and the oxyacetylene cutting processes are an integral aspect of this course.

**PMT 2122\*****Arc Welding II, 6 semester hours, 30 lec., 150 lab. (Offered as needed)**

An advanced arc welding course including: intensive coverage of welding symbols and blueprint reading, weld testing and inspection. Practical experience will be gained in out of position welding using a variety of arc welding electrodes.

**PMT 2405\*****Production Technology, 3 semester hours, 45 lec. (Offered as needed)**

Production Technology examines the new manufacturing technology that has resulted from the concepts of automation and integration in manufacturing. Some of the topics covered include: automated assembly, CAD/CAM, numerical control, industrial robots, lasers, flexible manufacturing, computer integrated manufacturing, and other related technologies.

**SUR 2100C\*****Surveying, 3 semester hours, 15 lec., 60 lab. (Fall, Spring)**

Measurement of distances; elevations and angles; analysis of errors; adjustments of instruments; computation of positions, areas and volumes; contours; establishing grades; topographic mapping and land surveying.

\*Occupational course that may not be applied toward the A.A. Degree.

**SUR 2140C\*****Surveying II, 3 semester hours, 15 lec., 60 lab. (Fall, Spring)**

This course covers advanced surveying concepts. Topics will include: measurement of distances, elevations and angles, analysis of errors, and adjustment of instruments. Additional coverage will include computation of positions, areas and volumes; contours, determining grades; topographic mapping and land surveying. Prerequisite: SUR 2100C or equivalent.

**TAR 2121C****Architectural Drafting, 3 semester hours, 15 lec., 60 lab. (Fall, Spring)**

Architectural design and development of residential and light commercial buildings to include: development and construction of good architectural freehand lettering, VA and FHA approved residential house plans, "Good Sense" house plans as defined in the Arkansas Plan, and heat loss/heat gain calculations. Prerequisite: EGS 1110C or ETD 1111 and BCN 1230 or equivalent.



## MANUFACTURING & TECHNOLOGY

### NONCREDIT COURSES (C.E.U.)

For information on Continuing Education Units, see page 87.

**ACR 0949****Air Conditioning and Heating: Apprentice, 60 class hours, 6 c.e.u.'s (Fall, Spring) 24 class hours, 2.4 c.e.u.'s (Summer)**

Related theory and classroom work for air conditioning and heating, apprentice training. Instruction in mathematics, blueprint reading, method of construction, safety, use of building materials, and other technical subjects.

**PMT 0184****Welder Qualification, 15 class hours, 3 lec., 12 lab., 1.5 c.e.u.'s (Offered as needed)**

A course covering an overview of welder qualifications (certification) and its importance to industry. Various welding codes will be introduced, such as: AWS, ASME, API, and Military Specifications (Mil. Specs.). The student will select one welding code on which he or she will be tested and will perform a practical welding qualification test to be evaluated by a Certified Welding Inspector Instructor. To qualify, the student's weldment must meet or exceed the test requirements specified by the selected welding code.

**PUR 0920****FPRA Exam Review, noncredit, 24 lecture hours. (Offered as needed)**

A review of basic knowledge required for satisfactory completion of the Florida Public Relations Association Exam.

**XXX 7600****Auto Mechanics for the Layman, 20 class hours, 2 c.e.u.'s (Fall)**

A course designed to prepare drivers to handle simple problems relating to the automobile, including the performance of simple maintenance. (Self-Supporting)

**XXX 7602****Introduction to Auto Mechanics, 20 class hours, 2 c.e.u.'s (Offered as needed)**

A course designed to make the student aware of the auto mechanics field by learning about the basic operation and the various systems of the automobile. Students will be taught to handle simple problems relating to the operation, maintenance and performance of the automobile.

**XXX 7603****Occupational Orientation, 8-45 class hours, .08-4.5 c.e.u.'s (Offered as needed)**

A course in which the student will receive an orientation to the world of work and will acquire skills in choosing an occupation, applying for a job, and maintaining and progressing in an occupation.

**XXX 7706****Home Industries (Offered as needed)**

A course designed to prepare individuals for the manufacturing of goods in the home to be sold- training in the construction of handicraft items such as leather-goods, ceramics, lapidary, woodworking, engraving, drawing, silk screen, and weaving. (Hours vary as to type of offering).

**XXX 7708****Contractor Exam Preparation, 60 class hours, 6 c.e.u.'s (Offered as needed)**

The purpose of this course is to prepare experienced contractors to pass the exam for contractor's certification. Topics covered include math review; working drawings; specifications; estimations and take-offs; business regulations, tax laws, building codes, and safety regulations; building materials; and accounting and cost keeping.

**XXX 7715****Electrical Wiring: Apprentice, 60 class hours, 6 c.e.u.'s (Fall, Spring) 24 class hours, 2.4 c.e.u.'s (Summer)**

Related theory and classroom work for electrical apprenticeship training. Training in the installation of wiring systems and lighting fixtures in a building, including layout conduits, installing switch panels, pulling wire, splicing, testing circuits, line construction and performing other duties and jobs required of an electrician.

**XXX 7732****Carpentry: Apprentice, 60 class hours, 6 c.e.u.'s (Fall, Spring) 24 class hours, 2.4 c.e.u.'s (Summer)**

Related theory and classroom work for carpentry, apprentice training. Instruction in mathematics, blueprint reading, method of construction, safety, use of building materials, and other technical subjects.

**XXX 7734****Plumbing and Pipefitting: Apprentice, 60 class hours, 6 c.e.u.'s (Fall, Spring), 24 class hours, 2.4 c.e.u.'s (Summer)**

Related theory and classroom work for plumbing and pipefitting, apprentice training. Instruction in mathematics, blueprint reading, method of construction, safety, use of building materials, and other technical subjects.

\*Occupational course that may not be applied toward the A.A. Degree.

**XXX 7735**

**Sheetmetal: Apprentice, 60 class hours, 6 c.e.u.'s (Fall, Spring) 24 class hours, 2.4 c.e.u.'s (Summer)**

Related theory and classroom work for sheetmetal apprentice training. Instruction in mathematics, blueprint reading, method of construction, safety, use of building materials, and other technical subjects.

**XXX 7774**

**Introduction to Computer Drafting, noncredit, 5 lec., 20 lab. hours. (Offered as needed)**

A course designed to help drafting students update their skills in the area of computer aided drafting. The course will include general background information on computer drafting theory as well as hands-on experience on computer drafting hardware.

**XXX 7843**

**Communication System, 45 class hours, 4.5 c.e.u.'s (Offered as needed)**

Communication systems and the factors affecting the design, operation and maintenance of receiving and transmission equipment. AC/DC theory, antennas, transistors, microwaves, oscillators and amplifiers are covered. Preparation for F.C.C. radio/telephone license examination.

**XXX 7981**

**Water Treatment Operator, 165 class hours, 16.5 c.e.u.'s (Offered as needed)**

Study of water treatment. This course will cover the operation of a water treatment plant and related mathematics, biology, chemistry, records, and reports used in the operation of a water treatment facility. This course is preparation for the state "B" level water plant operator certification. Prerequisite: Consent of instructor.

**XXX 7982**

**Beginning Wastewater Operator I, 142 class hours, 14.2 c.e.u.'s (Offered as needed)**

An introductory study of the field of wastewater treatment. This course will cover the operation of a wastewater plant and the related mathematics, biology, chemistry, laboratory records and reports used in the operation of a wastewater facility. This course is preparation of the State "B" level wastewater operator.

**MAC 1114**

**Trigonometry, 3 semester hours, 45 lec. (Fall, Spring, Summer)**

Typical modern trigonometry course. Prerequisite: MAC 1140 with a grade of "C" or better, or equivalent.

**MAC 1140**

**Pre-Calculus Algebra, 3 semester hours, 45 lec. (Fall, Spring, Summer)**

First course in a three-course pre-calculus sequence. Covers equations and inequalities; linear, quadratic, logarithmic and exponential functions and relations; systems of equations, matrices and determinants; mathematical proof techniques, including mathematical induction. Binomial theorem, sequences and series; and applications of algebraic techniques in the real world. Scientific-type calculators are used in logarithmic and exponential work. Prerequisite: Completion of MAC 1102 with a grade of "C" or better, or equivalent. Graphing calculators will be required.

**MAC 1154**

**Analytical Geometry, 3 semester hours, 45 lec. (Fall, Spring, Summer)**

Typical modern analytic geometry course in two and three space. Prerequisite: Completion of MAC 1140 and MAC 1114 with a grade of "C" or better, or equivalent.

**MAC 1411**

**Calculus I, 4 semester hours, 60 lec. (Fall, Spring, Summer)**

First course in a three course sequence. Covers basic concepts of differentiation and integration. Prerequisite: MAC 1140 and MAC 1114 and MAC 1154 with a grade of "C" or better, or equivalent.

**MAC 1412**

**Calculus II, 4 semester hours, 60 lec. (Fall, Spring, Summer)**

Second course in a three course sequence, and provides further insight into the methods and applications of differentiation and integration. Prerequisite: Completion of MAC 1411 with a grade of "C" or better, or equivalent.

**MAC 1413**

**Calculus III, 4 semester hours, 60 lec. (Fall, Spring, Summer)**

Third course in a three course sequence: It stresses multivariable calculus and infinite series. Prerequisite: Completion of MAC 1412 with a grade of "C" or better, or equivalent.

**MAC 2233**

**Calculus for Business, 3 semester hours, 45 lec. (Offered as needed)**

A calculus course covering limits, continuity, differentiation, and integration with emphasis on business applications. There is some mathematical theory; but, in general, topics are approached from an intuitive and applied point of view. Prerequisite: Grade of "C" or better in MAC 1140 or equivalent.

**MAP 2302**

**Differential Equations, 3 semester hours, 45 lec. (Fall, Spring)**

An introduction to ordinary differential equations with emphasis on first and second order linear equations and applications. Prerequisite: Either completion of MAC 1413 with a "C" or better or completion of MAC 1412 with a "C" or better and concurrent enrollment in MAC 1413. Equivalent courses from other institutions may be used to meet the prerequisite.

**MATHEMATICS**

**CREDIT COURSES**
**MAC 1102**

**Introductory College Algebra, 3 semester hours, 45 lec. (Fall, Spring, Summer)**

Includes extended factorization techniques; higher order radicals and roots in-depth study of quadratic equations and inequalities, solutions of systems of linear equations including use of determinants; study of functions and relations, logarithms and exponential functions, their properties and uses, graphs of linear and quadratic functions; the complex number system, absolute value equations and inequalities and an emphasis on word problems. Prerequisites: Completion of MAT 1033 with a "C" or better, appropriate test scores, or equivalent. Scientific calculators will be required.

**MAS 2103****Linear Algebra, 3 semester hours, 45 lec. (Fall, Spring)**

Designed for mathematics and engineering majors. Prerequisite: MAC 1411 with a grade of "C" or better, or equivalent.

**MAT 0002A\*****Developmental Arithmetic, 2 semester hour, 30 lec. (Fall, Spring, Summer)**

This course is designed for students whose entry level placement test scores may not meet requirements for degree credit. (By State Board of Education Rules, students are limited to three registrations in this course). It is designed to reinforce knowledge of operations with fractions, decimals, percents and signed numbers with applications. May be repeated by students not fulfilling competency requirements. Not applicable toward the associate degree. Students scoring below 45 on the new ASSET numerical skills test should take this course before enrolling in MAT 0024 or concurrently with MAT 0024.

**MAT 0024\*****College Preparatory Algebra, 3 semester hours, 30 lec., 45 lab. (Fall, Spring, Summer)**

This course is designed for students whose entry level placement test scores do not meet requirements for degree credit (does not meet graduation requirements). Course may be repeated by students not fulfilling competency requirements. (By State Board of Education Rules, students are limited to three registrations in this course). Topics include operations with real number properties, linear equations and inequalities and factorization.

**MAT 1033****Intermediate Algebra, 3 semester hours, 45 lec. (Fall, Spring, Summer)**

Topics include sets, equations, inequalities, absolute values, factorization, rational expressions, radicals, exponents, graphing, and quadratic equations. Prerequisite: Completion of MAT 0024 with a grade of "C" or better, score of 37 to 49 on the new ASSET, or equivalent.

**MAT 2905****Tutorial-Mathematics, 1 semester hour, 30 lab. (Fall, Spring, Summer)**

An experience in individual depth study in which one student prepares for and engages in tutoring another for two class periods per week. Prerequisite: Completion of course in which tutoring with a grade of "B" or better, or equivalent.

**MGF 2118****Math Preparation for CLAST, 1 semester hour, 15 lec. (Fall, Spring, Summer)**

A short course dealing with mathematical skills needed for successful completion of coursework in a variety of disciplines. Prerequisite: Completion of a general education mathematics course.

**MGF 2202****Finite Mathematics, 3 semester hours, 45 lec. (Fall, Spring, Summer)**

This course is designed to provide the essential mathematical skills necessary for a student entering his/her junior year of college. It includes arithmetic, geometry and measurement algebra, statistics (including probability), logical reasoning, and computing technology. Prerequisite: Completion of MAC 1102 or higher mathematics course with a grade of "C" or better, or equivalent.

**MTB 1321****Technical Math I, 3 semester hours, 45 lec. (Offered as needed)**

This course will include solving linear equations, factoring polynomials, graphing functions, solving quadratic equations, solving right triangles and oblique triangles, using vectors to solve problems in science and technology and solving word problems from technical fields. It will meet general education requirements for AS and ASO programs. Prerequisite: MAT 0024 with a C or better or satisfactory test scores.

**MTB 1322****Technical Math II, 3 semester hours, 45 lec. (Offered as needed)**

This course will include solving systems of equations, finding roots of higher degree equations, solving exponential and logarithmic equations, sketching the graphs of sine and cosine functions, solving trig equations, computation with complex numbers, graphing lines and graphing parabolas. It will meet general education requirements for AS and ASO programs. Prerequisite: MTB 1321 with a C or better.

**STA 2014****Statistics, 3 semester hours, 45 lec. (Fall, Spring, Summer)**

A course designed to provide general understanding and operational use of statistical techniques. Prerequisite: MAC 1102 Introduction to College Algebra with the minimum grade of "C."

**PUBLIC SAFETY****CREDIT COURSES****CCJ 1000****Introduction to Criminology, 3 semester hours, 45 lec. (Spring)**

A study of the nature and causes of crime and delinquency; the development of delinquent and criminal behavior; specific behavioral problems of addicts, compulsive and habitual offenders and juvenile offenders.

**CCJ 1020****Introduction to Criminal Justice, 3 semester hours, 45 lec. (Fall, Spring, Summer)**

An introduction to the philosophical and historical background of law enforcement and the administration of criminal justice. Organization and jurisdiction of local, state, and federal law enforcement agencies. Court and Criminal procedures. Career opportunities in Criminal Justice field.

**CCJ 1121****Crime Prevention, 3 semester hours, 45 lec. (Offered as needed)**

A course in crime prevention as it exists today in America. Study includes residential, personal and commercial crime prevention and it includes crime prevention resources, crime analysis and current legal implications. Designed primarily for in-service law enforcement officers but will not be limited to such personnel.

\*College preparatory credits may not be counted towards fulfilling the number of credits required for a degree.

**CCJ 1192****Crisis Intervention, 3 semester hours, 45 lec. (Offered as needed)**

A study of the nature and causes of human stress in crisis situations involving criminal justice practitioners to include law enforcement, judicial and correctional personnel: definitions, recognition and assessment, general calming techniques, intervention: safety, abnormal behavior and suicide, role playing, causes of psychological and physiological stress agents inherent in the duties of criminal justice practitioners and countermeasures to anxiety and stress reduction. Permission of the instructor needed.

**CCJ 1210****Criminal Law, 3 semester hours, 45 lec. (Fall, Spring, Summer)**

Fundamentals of Criminal Law to include historical background and development, jurisdiction, the criminal act and responsibility. Classification and analysis of Florida Statutes.

**CCJ 1230****Criminal Procedure, 3 semester hours, 45 lec. (Fall, Spring, Summer)**

Fundamentals of constitutional, criminal and civil law. Principles, duties and mechanics of criminal procedures in Florida as applied to arrest, search, seizure, and court processing. A functional analysis of the rules of evidence in court procedures.

**CCJ 1310\*****Discipline and Special Confinement Techniques, 3 semester hours, 45 lec. (Offered as needed)**

The student is introduced to the essentials of discipline and special confinement techniques necessary for the corrections profession. The topics to be introduced include physical operation, physical force, recognizing abnormal behavior, verbal and nonverbal communications.

**CCJ 1400****Police Organization and Administration, 3 semester hours, 45 lec. (Offered as needed)**

Principles of organization and administration in law enforcement; fundamentals of police planning: budget analysis, recruitment, training, and assignments; disciplinary problems and methods of control; cooperation with other agencies; public relations; records and inspection.

**CCJ 1500****Juvenile Delinquency, 3 semester hours, 45 lec. (Offered as needed)**

A study of the nature and cause of juvenile delinquency, the development of the delinquent and criminal behavior, specific criminal justice subsystem (law enforcement, judicial, corrections) problems dealing with juvenile delinquents from initial contact through final disposition and treatment.

**CCJ 1611\*****Child Abuse and Neglect, 3 semester hours, 45 lec. (Offered as needed)**

This course was designed to provide the student with an enhanced awareness of child abuse symptoms and patterns, including information and case studies on specific abuse and social problems.

\* Occupational course that may not be applied toward the A.A. Degree.

**CCJ 1650\*****Introduction to Narcotics Investigation, 3 semester hours, 45 lec. (Offered as needed)**

This introductory course in narcotics investigation and identification is designed to provide the student with an overview of narcotics and the role of the investigative agencies, drug traffic flow patterns, major classes of drugs and the drug profit traffic. Instruction will cover techniques of investigative observation, patrol and case development, physical identification of drugs, symptoms of abuse, methods of abuse and appropriate Florida Statutes. This is also a Criminal Justice Standards and Training Commission advanced course.

**CCJ 1935****Criminal Justice Seminar, 3 semester hours, 45 lec. (Offered as needed)**

Exploration, development and discussion of contemporary problems in the Criminal Justice System.

**CCJ 1941\*****Internship – Criminal Justice, 3 semester hours, 225 hrs. (Offered as needed)**

On-the-job training in the Associate of Science/ Applied Science Option program in which the student is enrolled. The student is under the supervision at work of a qualified supervisor. The supervisor will rate the student's performance, knowledge, comprehension, dependability, initiative, cooperativeness, and total performance. A project paper or approved project will be submitted by the student three weeks prior to the close of the semester. May be repeated four times for a total of 12 semester hours. Prerequisite: Must be enrolled in at least one other course in the respective degree program.

**CCJ 2070****Computer Applications in Criminal Justice, 3 semester hours, 45 lec. (Offered as needed)**

Computer Applications in Criminal Justice introduces the participant to the use of the computer in Criminal Justice applications. The participant will be introduced to prepackaged software and the process used to modify the package to criminal justice usage. This will include an electronic filing system designed to store, review and update data which can be manipulated into printed reports for daily and periodic usage.

**CCJ 2300****Introduction to Corrections, 3 semester hours, 45 lec. (Fall)**

Theories of punishment and incarceration; the organization of correction programs and institutions, principles of probation and parole, role of parole and probation officers, legal implications; problems of rehabilitation.

**CCJ 2330****Intro. Probation & Parole, 3 semester hours, 45 lec. (Offered as needed)**

This course reviews the theories and practices of probation and parole within a community setting. The study of probation and parole as it is used as a behavior modification process is considered.

**CCJ 2905****Independent Study – Criminal Justice, 1 semester hour, 45 lab. (Fall, Spring)**

Directed study and individual projects to meet the student's interests in a specialized area of Criminal Justice for which present course availability is limited.

**CJD 1200****Law Officer Skills, 4 semester hours, 60 lec. (Offered as needed)**

A skills development course designed to upgrade the auxiliary and/or inservice police officer in the areas of driver improvement, arrest techniques, stress reduction, medical emergencies and use of firearms. A Florida Standards Salary Incentive course.

**CJD 1250\*****Interviews and Interrogations, 3 semester hours, 45 lec. (Offered as needed)**

An advanced course designed to cover the techniques, methods, principles, and issues of interviewing and interrogations. Course meets Florida Police Standards Salary Incentive Requirements.

**CJD 1253\*****Defensive Tactics, 5 semester hours, 60 lec., 20 lab. (Offered as needed)**

This course is designed to qualify students and especially in-service law enforcement and correctional officers in the art of defensive tactics and self-defense; to include the legal aspects of the use of force; preconditioning, defense and injury protection, defenses to unarmed attack, defenses against armed attacks, and the regulations, laws and techniques relating to the use of force. This is an advanced course under rules of the Florida Criminal Justice Standards and Training Commission .

**CJD 1420\*****Correctional Law, 3 semester hours, 45 lec. (Offered as needed)**

A course in practical law for correctional personnel. Study includes law regulating use of forces, civil rights of prisoners, constitutional law, legal service, disciplinary proceedings, parole, and current case law.

**CJD 1450\*****Introduction to Basic Corrections, 3 semester hours, 45 lec. (Offered as needed)**

This course is designed to introduce the participant to basic corrections law and its role within the criminal justice system, based on established standards of the Department of Law Enforcement and the Criminal Justice Standards and Training Commission. Prerequisites: Students must be sponsored by a state or local correctional agency and earn minimum entry level placement scores required for college level English communications courses.

**CJD 1460\*****Correctional Operations, 3 semester hours, 45 lec. (Offered as needed)**

Responsibilities, powers, and duties of the correctional officer, correctional administration; physical security; facility services intake, classification and release procedures; special programs; human skills; understanding and responding to inmate behavior and correctional proficiency skills.

**CJD 1462\*****Basic Correctional Techniques, 3 semester hours, 45 lec. (Offered as needed)**

This course is designed to provide the participant with the various techniques used in a correctional facility when dealing with communication, emergency procedures and inmate control, based on established requirements of the Florida Department of Law Enforcement and Criminal Justice Standards and Training Commission.

**CJD 1468\*****Youthful Offenders, 3 semester hours, 45 lec. (Offered as needed)**

A course designed to provide the student with an overview and awareness of Florida youthful offender programs to include; facilities and specialized programs, staff-inmate relations, one-way/two-way communications and effective communications and effective communications skills, positive characteristics for staff working with youthful offenders; the helping relationship inventory, local treatment programs, opportunities and alternatives, treatment problem solving and other techniques relating to youthful offenders.

**CJD 1501\*****Criminal Justice Instructor Techniques, 5 semester hours, 60 lec., 20 lab. (Offered as needed)**

A basic course in instrumental principles designed to equip the law enforcement specialist with techniques of classroom and field training methods.

**CJD 1602\*****Drug Awareness, 3 credits, 45 lec. (Offered as needed)**

This course is a part of the Criminal Justice Standards and Training Commission approved Advanced Training Program. It is designed to familiarize students with common drug abuse terms, classes of drugs, pharmacological information relating to commonly used and abused chemicals and their effects, an overview on use patterns and characteristics of drug abusers, how to troubleshoot and deal with problems that develop among abusers and effective presentation skills.

**CJD 1610\*****Criminal Investigative Techniques, 3 semester hours, 34 lec. (Offered as needed)**

A course designed to provide the student with instruction in Florida investigative concepts and techniques, use of evidence and related matters.

**CJD 1625\*****Special Tactical Problems for Law Enforcement, 3 semester hours, 45 lec. (Offered as needed)**

This course is a part of the Criminal Justice Standards and Training Commission Advanced Training Program. It is designed to prepare law enforcement officers for police operations which involve special tactical situations and will include; importance of physical well-being in the Criminal Justice setting, an overview of Florida local disaster procedures, civil disorder patterns, special task force unit operations, special crime areas and practical exercises.

**CJD 1631\*****Florida Police Operations and Leadership, 5 semester hours, 80 lec. (Offered as needed)**

A course designed to provide the student with instruction in Florida patrol techniques, criminal investigations, civil and criminal liability matters, discretion/decision making and related matters.

**CJD 1680\*****Florida Criminal Law, 5 semester hours, 80 lec. (Offered as needed)**

A course designed to provide the student with an overview of criminal law, laws of arrest, rules of evidence, etc. concerning Florida law.

\* Occupational course that may not be applied toward the A.A. Degree.

**CJD 1700\*****Criminal Justice Legal I, 3 semester hours, 45 lec. (Offered as needed)**

Criminal Justice Legal I provides an introductory overview of the Criminal Justice System and a history of law. The foundation and basic components of law are studied with specific focus upon officer application. Court procedure and testimony are examined. Objectives are addressed as specified by the Criminal Justice Standards Training Commission.

**CJD 1701\*****Criminal Justice Legal II, 3 semester hours, 45 lec. (Offered as needed)**

Constitutional Law and its application to the public and officers are examined. Law – including evidence procedures, arrest laws, search and seizure, and various statutory laws that are common to Police and Correctional officers – are studied. Emphasis is given to elements of various crimes. Various civil law applications are covered. Civil and criminal liability of officers is studied. Objectives are addressed as specified by the Criminal Justice Standards and Training Commission.

**CJD 1702\*****Criminal Justice Communications, 3 semester hours, 45 lec. (Offered as needed)**

The report-writing process – from the interview, statement taking, and note-taking, through the final report product – is covered with practical exercises included. The differences between interviewing and interrogation are explored. Interpersonal skills in communication are covered along with radio and telephone procedures. Objectives are addressed as specified by the Criminal Justice Standards and Training Commission.

**CJD 1703\*****Criminal Justice Interpersonal Skills I, 3 semester hours, 45 lec. (Offered as needed)**

Community relations techniques and courtesy are addressed with emphasis given to crime prevention. The needs of various groups within society are addressed including: juveniles, the elderly, ethnic and cultural groups, the mentally ill and retarded, the physically handicapped, and substance abusers. Intervention techniques for various situations including: suicide, domestic violence, and other crises are studied, with practical exercises. Stress recognition and reduction are included. Objectives are addressed as specified by the Criminal Justice Standards and Training Commission.

**CJD 1704\*****Criminal Justice Defensive Tactics, 4 semester hours, 45 lec., 30 lab. (Offered as needed)**

Instruction includes the techniques used for an officer's personal safety and those necessary to subdue, search, and then transport resisting individuals. The use of restraining devices, impact weapons, and pressure points are covered. Objectives are addressed as specified by the Criminal Justice Standards and Training Commission.

**CJD 1705\*****Criminal Justice Weapons, 2 semester hours, 15 lec., 30 lab. (Offered as needed)**

Criminal Justice Weapons includes instruction in the use of officer firearms including handguns and shotguns. Safety procedures and ammunition use are

covered in lecture. Instruction includes the use of chemical agents, with practical exercises included. Objectives are addressed as specified by the Criminal Justice Standards and Training Commission.

**CJD 1706\*****Independent Study – Criminal Justice Legal I, 1 semester hour (Offered as needed)**

This course allows for the bridging between noncredit and credit Criminal Justice Legal I. An independent study focusing on an overview of the criminal justice system and a history of law.

**CJD 1707\*****Independent Study – Criminal Justice Legal II, 1 semester hour (Offered as needed)**

This course allows for the bridging between noncredit and credit Criminal Justice Legal III. An independent study focusing on constitutional law and its application to the public and law enforcement officers.

**CJD 1708\*****Independent Study – Criminal Justice Communications, 1 semester hour (Offered as needed)**

This course allows for the bridging between noncredit and credit Criminal Justice Communications. An independent study focusing on the report writing process – from the interview statement taking, and note-taking, through the final report.

**CJD 1709\*****Independent Study – Interpersonal Skills I, 1 semester hour (Offered as needed)**

This course allows for the bridging between noncredit and credit Interpersonal Skills I. An independent study focusing on community relations techniques and courtesy with emphasis given to crime prevention.

**CJD 1721\*****Law Enforcement Patrol, 3 semester hours, 45 lec. (Offered as needed)**

Law Enforcement Patrol addresses the skills and techniques that are needed by officers daily to do patrol tactics and respond to various types of calls. Methods of approach to various high-risk situations are explored, with practical exercises included. Unusual occurrence events, including fire-fighting and crowd control are addressed. Objectives are addressed as specified by the Criminal Justice Standards and Training Commission.

**CJD 1722\*****Law Enforcement Traffic, 3 semester hours, 5 lec. (Offered as needed)**

Law Enforcement Traffic studies traffic enforcement and control, with the inclusion of DUI offenses and enforcement. Traffic accident investigation, scene management, and reporting procedures are studied. Objectives are addressed as specified by the Criminal Justice Standards and Training Commission.

**CJD 1723\*****Law Enforcement Vehicle Operation, 3 semester hours, 30 lec., 15 lab. (Offered as needed)**

The components of the police driving environment are explored, and practical exercises on the driving range are conducted. Objectives are addressed as specified by the Criminal Justice Standards and Training Commission.

\* Occupational course that may not be applied toward the A.A. Degree.

**CJD 1724\*****Law Enforcement Investigations, 4 semester hours, 60 lec. (Offered as needed)**

Law Enforcement Investigations addresses investigation of various crimes, including property crimes, persons crimes, narcotics offenses, vice, organized crime, terrorist activity, bombing incidents, and death investigations. Techniques are developed from the initial observation methods through the processing of the crime scene and case preparation. Florida's computer network is studied as an information source. Objectives are addressed as specified by the Criminal Justice Standards and Training Commission.

**CJD 1726\*****Independent Study – Law Enforcement Legal III, 1 semester hour (Offered as needed)**

This course allows for the bridging between noncredit and credit Law Enforcement Legal III. An independent study focusing on various criminal laws and their elements. Emphasis is placed upon those laws specific to law enforcement.

**CJD 1727\*****Independent Study – Law Enforcement Patrol, 1 semester hour (Offered as needed)**

This course allows for the bridging between noncredit and credit Law Enforcement Patrol. An independent study focusing on the skills and techniques that are needed by officers daily to do patrol tactics and respond to various types of calls.

**CJD 1728\*****Independent Study – Law Enforcement Traffic, 1 semester hour (Offered as needed)**

This course allows for the bridging between noncredit and credit Law Enforcement Traffic. An independent study focusing on traffic enforcement and control, with the inclusion of DUI offenses and enforcement.

**CJD 1729\*****Independent Study – Law Enforcement Investigating, 1 semester hour (Offered as needed)**

This course allows for the bridging between noncredit and credit Law Enforcement Investigation. An independent study focusing on investigation of various crimes, including property crimes, person crimes, narcotics offenses, vice, organized crime, terrorist activity, bombing incidents, and death investigation.

**CJD 1740\*****Criminal Justice Interpersonal Skills II, 3 semester hours, 45 lec. (Offered as needed)**

The interpersonal skills needed by officers to understand the incarcerated society are explored, with emphasis upon supervision methods. Inmate adjustment and the various segments of the society are studied. The course includes the study of homosexuality, female inmates, deception and manipulation by inmates, and institutional criminalities. Objectives are addressed as specified by the Criminal Justice Standards and Training Commission.

**CJD 1741\*****Correctional Emergency Preparedness, 2 semester hours, 30 lec. (Offered as needed)**

Skills needed for riot and disturbance control and fire-fighting are studied and practiced. Lecture includes methods of riot prevention, handling of unusual occurrences, what to do if taken hostage, and emergency procedures. Objectives are addressed as specified by the Criminal Justice Standards and Training Commission.

**CJD 1742\*****Correctional Operations, 4 semester hours, 60 lec. (Offered as needed)**

The operation of correctional facilities is studied – including the intake of new inmates, all aspects of their daily care, institutional procedures, and techniques utilized by officers to do daily tasks. Objectives are addressed as specified by the Criminal Justice Standards and Training Commission.

**CJD 1746\*****Independent Study – Interpersonal Skills II, 1 semester hour (Offered as needed)**

This course allows for the bridging between noncredit and credit Interpersonal Skills II. An independent study focusing on interpersonal skills needed by officers to understand the incarcerated society are explored, with emphasis upon supervision methods. Objectives are addressed as specified by the Criminal Justice Standards and Training Commission.

**CJD 1748\*****Independent Study – Correctional Operations, 1 semester hour (Offered as needed)**

This course allows for the bridging between noncredit and credit. An independent study focusing on the operation of correctional facilities – including the intake of new inmates, all aspects of their daily care, institutional procedures, and techniques utilized by officers to do daily tasks. Objectives are addressed as specified by the Criminal Justice Standards and Training Commissions.

**CJD 1930\*****Human Diversity Workshop, 2 semester hours, 30 lec. (Offered as needed)**

This course is designed to enhance the participant's awareness of their own cultural rules and predispositions and how these cultural influences come into play in common interactions with others. This awareness is used to develop the participants' understanding of issues related to human diversity: gender, race, ethnicity, etc. The program also presents basic skills and knowledge related to interacting with diverse individuals and groups.

**CJD 2254\*****First Responder for Law Enforcement, 3 semester hours, 45 lec. (Offered as needed)**

This course is designed primarily to qualify in-service law enforcement and correctional officers in the area of first responder to medical emergencies to include: introduction to first responder training, overview of the human body, diagnostic signs of patient examination, airway care & pulmonary resuscitation, cardiopulmonary resuscitation, shock, bleeding, primary patient care and injuries.

**CJD 2310\*****Criminal Justice Supervision, 5 semester hours, 80 lec. (Offered as needed)**

A career development course for full time police officers designed to train the line supervisor.

**CJD 2320\*****Criminal Justice Management, 5 credits, 80 lec. (Offered as needed)**

An advanced course designed to train criminal justice supervisors in the techniques and procedures necessary for middle managers.

\* Occupational course that may not be applied toward the A.A. Degree.



**CJD 2330****Behavioral Climate for Criminal Justice, 3 semester hours, 45 lec. (Offered as needed)**

This is an advanced course in the Florida Criminal Justice Standards and Training Commission program. It is designed for law enforcement, corrections, and correctional probation and parole officers and includes instructions in the factors that affect the behavioral climate of organizations, various periods of management philosophy, definitions of the job role and theory of cognitive dissonance, and techniques of motivation, communication and discipline.

**CJD 2461\*****Advanced Correctional Operations, 3 semester hours, 45 lec. (Offered as needed)**

An advanced course in correctional operations for inservice Florida Correctional Officers designed to increase skills in correctional agency organization and mission, records and reports, legal applications to correctional operations, correctional facility security, intake/classification/release procedures, fire safety and discipline procedures, introduction to supervision and release and bonding procedures. This is course number 59 in the series approved by the Florida Criminal Justice Standards and Training Commission Advanced Courses.

**CJD 2467****Counseling and Communications Skills, 3 semester hours, 45 lec. (Offered as needed)**

Designed to give the participant an understanding of the fundamentals of counseling and communication skills needed by state correctional officers.

**CJD 2470\*****Emergency Preparedness for Correctional, 3 semester hours, 45 lec. (Offered as needed)**

This course is designed to qualify in-service correctional officers and correctional support personnel in the area of emergency preparedness, to include; emergency plans, specifics on disturbances and disorder planning, hostage plans and situations, factors affecting emergency planning and management and leadership.

**CJD 2605****Traffic Homicide Investigation, 3 semester hours, 45 lec. (Offered as needed)**

Course content covers traffic homicide investigation skills to include reconstruction, meets Florida Justice Standards and training certification requirements for career development.

**CJD 2626\*****Hostage Negotiations for Criminal Justice, 3 semester hours, 45 lec. (Offered as needed)**

This course is designed to qualify in-service law enforcement and correctional officers and support personnel in the area of hostage negotiations, to include; introduction to the problem, types of hostage negotiations principles, communications principles, intelligence gathering, abnormal behavior and participant performance exercises.

**CJD 2632\*****Field Training Officer Techniques, 3 semester hours, 45 lec. (Offered as needed)**

Designed to introduce the criminal justice student (law enforcement and corrections) to all aspects of field

training and evaluation programs to include adult learning and instruction, evaluation, role responsibilities and characteristics of the Field Training Officer (F.T.O.) communications techniques, counseling techniques, legal and ethical issues and human motivation. This is course number 51 in the series approved by the Florida Criminal Justice Standards and Training Commission Advanced Courses.

**CJD 2670\*****Confidential Informants, 3 semester hours, 45 lec. (Offered as needed)**

This course is designed for in-service law enforcement, correctional officers and support personnel to qualify them in the area of development of confidential informants and other sources of information, to include; definition and management of an informant program, legal aspects of dealing with informants, and the development of other sources of investigative information.

**CJD 2681\*****Court Case Preparation and Court Presentation, 3 semester hours, 45 lec. (Offered as needed)**

Fundamentals of criminal case preparation and court presentation for the law enforcement and/or correctional officer to include case files, pre-trial discovery, depositions, plea bargaining, court testimony, moot court, post adjudication responsibilities, case studies and a practical exercise. This is course number 20 in the series approved by the Florida Criminal Justice Standards and Training Commission Advanced Courses.

**CJD 2691\*****Stress Awareness and Resolution, 3 semester hours, 45 lec. (Offered as needed)**

A course designed to provide the student with an overview and awareness of stress and its resolution, to include: identification of various types of stress, the results of stress, psychological methods of controlling stress, case study analysis, and spouse awareness and involvement. This is course number 50 in the series approved by the Florida Criminal Justice Standards and Training Commission Advanced Courses.

**CJD 2720\*****Law Enforcement Legal III, 3 semester hours, 45 lec. (Offered as needed)**

Various criminal laws and their elements are studied. Emphasis is placed upon those laws specific to police application. Traffic and driver's license laws are studied. Legal considerations of officer vehicle operation are addressed as specified by the Criminal Justice Standards and Training Commission.

**CJT 1120****Crime Scene Procedures, 3 semester hours, 45 lec. (Offered as needed)**

Course emphasizes preliminary investigation techniques, crime scene protection, recording, processing, collection and preservation of evidence, fingerprint technology and legal aspects of evidence.

**CJT 1310****Basic Firearms, 1 semester hour, 30 lab. (Offered as needed)**

A basic orientation course in the use of firearms. Range and weapons safety and legal provisions on use of weapons will be taught. Students will fire for record on standard 25 yard Bullseye course. Restricted to students enrolled in Criminal Justice degree programs.

\* Occupational course that may not be applied toward the A.A. Degree.

**CJT 2100****Criminal Investigation, 3 semester hours, 45 lec. (Offered as needed)**

Fundamentals of investigation; duties and responsibilities of the detective's interrogation techniques; search and techniques of protecting the crime scene; collection and preservation of evidence; modus operandi systems; scientific aids and other sources of information; court preparation and case followup.

**CJT 2140****Introduction to Criminalistics, 3 semester hours, 45 lec. (Fall, Spring)**

The scientific aspects of investigation and crime scene technology, crime laboratory functions, ballistics, dactyloscopy and latent print development, scientific methods of criminal identification.

**CJT 2220\*****Law Enforcement Photography, 3 semester hours, 45 lec. (Offered as needed)**

A basic course in police photography techniques to include photographic principles, illumination, composition, identification, fingerprint, crime scene, traffic accident, courtroom technician darkroom and film processing, enlarging, printing and field application. By permission of instructor. Prerequisite: CJT 2100 or XXX 6851 or CJT 2340.

**CJT 2340****Police Operations, 3 semester hours, 45 lec. (Fall, Spring)**

Responsibilities, powers, and duties of the uniformed patrolman; patrol techniques and procedures; field interrogation and note-taking; mechanics of arrest and search; handling of the mentally ill; transportation of prisoners; elements of property protection; fundamentals of community relations; mob and riot control, traffic enforcement programs and techniques.

**CJT 2350\*****Writing and Reviewing Reports, 3 semester hours, 45 lec. (Offered as needed)**

Designed to give students a broad understanding of writing and reviewing criminal justice reports. Specifically designed for correctional and law enforcement officers.

**CJT 2410****Traffic, 3 semester hours, 45 lec. (Offered as needed)**

A basic course in traffic fundamentals to include enforcement of the State of Florida Uniform Traffic Law, accident investigation techniques and control and regulation of traffic. Safe driving techniques will also be covered.

**CJT 2430****Traffic Accident Investigation, 3 semester hours, 45 lec. (Offered as needed)**

Traffic law and arrest procedures, traffic accident reports, accident reconstruction, traffic accident investigation, homicide and hit-and-run investigation, interviews and interrogation.

**EMS 1065C****Cardiopulmonary Resuscitation, 1 semester hour, 10 lec., 5 lab. (Offered as needed)**

To train the lay-public in the essentials of prudent heart living. To give each trainee a background knowledge of the physiology of the cardiopulmonary system. To train each trainee in the motor skills involved in the application of CPR in the field and to clear obstructed airways.

**EMT 2159C****Emergency Medical Technology, 8 semester hours, 105 lec., 30 lab., 45 clinical hours (Offered as needed)**

Emergency Medical Technology is the first course of training for a career in emergency medical services. The course covers all techniques of emergency medical care considered within the responsibilities of emergency medical technicians as well as operation aspects of the profession. EMT Admission Forms, outlining course prerequisites, are available at the OWCC Admissions Office.

**FFP 1000\*****Introduction to Fire Science, 3 semester hours, 45 lec. (Offered as needed)**

A study of the phenomena and incidents of fire; the principles of fire prevention, suppression, and protection; a review of municipal fire protection ratings and components; survey of professional fire protection career opportunities.

**FFP 1100\*****Fire Protection, Organization and Administration, 3 semester hours, 45 lec. (Fall, Summer)**

Principles of organization and administration in fire protection service; the structure and function of battalion and company as components of municipal organizations; duties and responsibilities of the company officer; a study of company personnel management and training, budgeting, records, reports, and public relations.

**FFP 2200\*****Fundamentals of Fire Prevention, 3 semester hours, 45 lec. (Fall, Spring)**

Fire prevention organization; techniques of fire prevention interpretation and application of fire code; recognition and elimination of fire hazards, fundamentals of public relations for fire services.

**FFP 2240\*****Arson Detection and Investigation, 3 semester hours, 45 lec. (Offered as needed)**

An introduction to arson laws and types of incendiary fires. Students learn methods of determining fire cause, recognizing and preserving evidence, etc. Prerequisite: Sophomore standing in Fire Science Technology or employed Firefighter, or equivalent.

**FFP 2300\*****Fire Codes and Building Construction, 3 semester hours, 45 lec. (Spring, Summer)**

A study of fire codes and standards used in building and transportation; role of the State Fire Marshall; fixed fire protection devices; survey of research and standards development. Prerequisite: Introduction to Fire Science.

**FFP 2410\*****Fire Fighting Tactics and Strategy I, 3 semester hours, 45 lec. (Fall, Spring)**

A study of the basic concepts involved in fire fighting; including fire behavior; fire fighting fundamentals; principles of extinguishment; the proper role for utilization of various fire companies; preplanning fire problems. Prerequisite: Introduction to Fire Science.

\*Occupational course that may not be applied toward the A.A. Degree.

**FFP 2420\*****Fire Fighting Tactics and Strategy II, 3 semester hours (Spring, Summer)**

A study of the principles utilized on fire ground for maximum manpower and equipment utilization; fire ground administration starting with a small fire, on up through major conflagrations, emphasis will be on developing thinking skills in relation to crisis. Prerequisite: FFP 2410.

**FFP 2500\*****Explosives and Hazardous Material I, 3 semester hours, 45 lec. (Offered as needed)**

Storage, handling laws, standards, and fire fighting practices pertaining to hazardous solids, liquids, gases, and commercial explosives.

**FFP 2501\*****Explosives and Hazardous Material II, 3 semester hours, 45 lec. (Offered as needed)**

Prepares student to deal with explosive hazardous materials to include; identification, storage, handling, laws, standards and fire fighting practices relating to hazardous solids, liquids, gases, and commercial explosives; hazardous team operations, safety practices, incident command at chemical incidents; scene operations and control techniques.

**FFP 2600\*****Fire Apparatus, 3 semester hours, 45 lec. (Fall, Spring) (Offered as needed)**

Principles and operation of ladder trucks, pumping engines, and other specialized equipment. Includes study of basic hydraulics.

**FFP 2620\*****Automatic Alarm and Extinguishing Systems, 3 semester hours, 45 lec. (Spring, Summer)**

A study of the types of fixed extinguishing systems, standard and special fire alarm and fire detection systems. Includes their operation, installation requirements, testing, inspection, maintenance.

**FFP 2640\*****Fire Service Hydraulics, 3 semester hours, 30 lec., 30 lab. (Offered as needed)**

A study of the physical laws relating to hydrostatics (fluids at rest) and hydrokinetics (fluids in motion). This course also provides practical experience in performing fire flow tests, pump performance tests and in calculating friction loss in various size hose. Prerequisite: FFP 1100.

**OST 1131****Legal Typewriting, 3 semester hours, 75 lab. (Offered as needed)**

Thorough analysis and formatting of legal documents.

**PLA 1003****Introduction to Paralegalism, 3 semester hours, 45 lec. (Offered as needed)**

Designed to give students a broad understanding of the nature of the paralegal professional and its responsibility.

**PLA 1013\*****Introduction to the Legal System, 3 semester hours, 45 lec. (Offered as needed)**

An introduction to Law and the Legal System.

**PLA 1051****Legal Terminology, 3 semester hours, 45 lec. (Offered as needed)**

This course is designed to give an explanation of the common legal vocabulary involved in the broad, general principles of substantive and common law.

**PLA 1104\*****Case Analysis and Legal Writing, 3 semester hours, 45 lec. (Offered as needed)**

This course was designed to provide the student with necessary skills and knowledge required in case analysis and legal writing.

**PLA 1105****Legal Research, 3 semester hours, 45 lec. (Offered as needed)**

The student is systematically introduced to the essentials of legal research in such areas as searching for precedence, gathering citations and legal opinions, preparing legal briefs and conducting title searches.

**PLA 1203****Introduction to Civil Law, 3 semester hours, 45 lec. (Offered as needed)**

An insight into the system of dispute resolution for private parties and the government provided by the court systems of the various states and the Federal Government in a noncriminal setting.

**PLA 1460****Bankruptcy Law, 3 semester hours (Offered as needed)**

An introduction into the purpose of Bankruptcy laws and the basis and structure of the Bankruptcy laws.

**PLA 1603\*****Wills, Trusts, and Probate, 3 semester hours, 45 lec. (Offered as needed)**

An introduction to estate planning, wills, and probate administration.

**PLA 1763\*****Law Office Management, 3 semester hour, 45 lec. (Offered as needed)**

This course was designed to provide the student with skills and knowledge necessary for management of a law office.

**PLA 1803****Family Law, 3 semester hours (Offered as needed)**

Study of the law relating to family and marriage and the role of the attorney.

**PLA 1804****Introduction to Family Law, 3 semester hours, 45 lec. (Offered as needed)**

An introduction to practice as they relate to family law.

**PLA 2263****Rules of Evidence, 3 semester hours, 45 lec. (Offered as needed)**

The student is introduced to the rules of evidence as they apply in civil and criminal court procedures. The student is prepared to locate legal case law in reference to evidence.

**PLA 2273****TORTS: Personal Injury Litigation, 3 semester hours, 45 lec. (Offered as needed)**

This course is designed to provide the student with an introductory knowledge of tort law with objectives centered on personal injury torts.

\*Occupational course that may not be applied toward the A.A. Degree.

PLA 2949

**Internship – Paralegal, 3 semester hours, 90 lab. (Offered as needed)**

On-the-job training in the Associate of Science/ Applied Science Option program in which the student is enrolled. The student is under the supervision, at work, of a qualified supervisor. The supervisor will rate the student's performance, knowledge, comprehension, dependability, initiative, cooperativeness, and total performance. A project paper or approved project will be submitted by the student three weeks prior to the close of the semester. May be repeated four times. Only three credits can be applied toward graduation.



## PUBLIC SAFETY

### NONCREDIT COURSES

For information on Continuing Education Units, see page 87.

**CJD 0606**

**Traffic Homicide Investigation, 40 class hours, 30 lec., 10 lab., 4 c.e.u.'s (Offered as needed)**

This course meets Florida Criminal Justice Standards and Training Certification requirements for career development. Course content covers traffic homicide investigation skills to include reconstruction, forensic science, law and arrest procedures, homicide report writing.

**CJD 0693**

**Police Intervention, 45 class hours, 4.5 c.e.u.'s (Offered as needed)**

A study of the nature and causes of human stress in crisis situations involving criminal justice practitioners to include law enforcement, judicial and corrections personnel; definitions, recognition and assessment, general calming techniques, intervention; safety, abnormal behavior and suicide, role playing, causes of psychological and physiological stress agents inherent in the duties of criminal justice practitioners, and countermeasures to anxiety and stress reduction.

**CJD 0700**

**Criminal Justice Legal I, noncredit, 45 lec. (Offered as needed)**

Criminal Justice Legal I provides an introductory overview of the Criminal Justice System and a history of law. The foundation and basic components of law are studied with specific focus upon officer application. Court procedure and testimony are examined. Objectives are addressed as specified by the Criminal Justice Standards Training Commission.

**CJD 0701**

**Criminal Justice Legal II, noncredit, 45 lec. (Offered as needed)**

Constitutional Law and its application to the public and officers are examined. Law – including evidence procedures, arrest laws, search and seizure, and various statutory laws that are common to Police and Correctional officers – are studied. Emphasis is given to elements of various crimes. Various civil law applications are covered. Civil and criminal liability of officers is studied. Objectives are addressed as specified by the Criminal Justice Standards and Training Commission.

**CJD 0702**

**Criminal Justice Communications, noncredit, 45 lec. (Offered as needed)**

The report-writing process – from the interview, statement taking, and note-taking, through the final report product – is covered with practical exercises included. The differences between interviewing and interrogation are explored. Interpersonal skills in communication are covered along with radio and telephone procedures. Objectives are addressed as specified by the Criminal Justice Standards and Training Commission.

**CJD 0703**

**Criminal Justice Interpersonal Skills I, noncredit, 45 lec. hours (Offered as needed)**

Community relations techniques and courtesy are addressed with emphasis given to crime prevention. The needs of various groups within society are addressed including: juveniles, the elderly, ethnic and cultural groups, the mentally ill and retarded, the physically handicapped, and substance abusers. Intervention techniques for various situations including: suicide, domestic violence, and other crises are studied, with practical exercises. Stress recognition and reduction are included. Objectives are addressed as specified by the Criminal Justice Standards and Training Commission.

**CJD 0704**

**Criminal Justice Defensive Tactics, noncredit, 75 lec. hours (Offered as needed)**

Instruction includes the techniques used for an officer's personal safety and those necessary to subdue, search, and then transport resisting individuals. The use of restraining devices, impact weapons, and pressure points are covered. Objectives are addressed as specified by the Criminal Justice Standards and Training Commission.

**CJD 0705**

**Criminal Justice Weapons, noncredit, 45 lec. hours (Offered as needed)**

Criminal Justice Weapons includes instruction in the use of officer firearms including handguns and shotguns. Safety procedures and ammunition use are covered in lecture. Instruction includes the use of chemical agents, with practical exercises included. Objectives are addressed as specified by the Criminal Justice Standards and Training Commission.

**CJD 0720**

**Law Enforcement Legal III, noncredit, 45 lec. hours (Offered as needed)**

Various criminal laws and their elements are studied. Emphasis is placed upon those laws specific to police application. Traffic and driver's license laws are studied. Legal considerations of officer vehicle operation are addressed as specified by the Criminal Justice Standards and Training Commission.

\*Occupational course that may not be applied toward the A.A. Degree.

**CJD 0721****Law Enforcement Patrol, noncredit, 45 lec. hours (Offered as needed)**

Law Enforcement Patrol addresses the skills and techniques that are needed by officers daily to do patrol tactics and respond to various types of calls. Methods of approach to various high-risk situations are explored, with practical exercises included. Unusual occurrence events, including fire-fighting and crowd control are addressed. Objectives are addressed as specified by the Criminal Justice Standards and Training Commission.

**CJD 0722****Law Enforcement Traffic, noncredit, 5 lec. hours (Offered as needed)**

Law Enforcement Traffic studies traffic enforcement and control, with the inclusion of DUI offenses and enforcement. Traffic accident investigation, scene management, and reporting procedures are studied. Objectives are addressed as specified by the Criminal Justice Standards and Training Commission.

**CJD 0723****Law Enforcement Vehicle Operation, noncredit, 30 lec., 15 lab. (Offered as needed)**

The components of the police driving environment are explored, and practical exercises on the driving range are conducted. Objectives are addressed as specified by the Criminal Justice Standards and Training Commission.

**CJD 0724****Law Enforcement Investigations, noncredit, 60 lec. hours (Offered as needed)**

Law Enforcement Investigations addresses investigation of various crimes, including property crimes, persons crimes, narcotics offenses, vice, organized crime, terrorist activity, bombing incidents, and death investigations. Techniques are developed from the initial observation methods through the processing of the crime scene and case preparation. Florida's computer network is studied as an information source. Objectives are addressed as specified by the Criminal Justice Standards and Training Commission.

**CJD 0740****Criminal Justice Interpersonal Skills II, noncredit, 45 lec. hours (Offered as needed)**

The interpersonal skills needed by officers to understand the incarcerated society are explored, with emphasis upon supervision methods. Inmate adjustment and the various segments of the society are studied. The course includes the study of homosexuality, female inmates, deception and manipulation by inmates, and institutional criminalities. Objectives are addressed as specified by the Criminal Justice Standards and Training Commission.

**CJD 0741****Correctional Emergency Preparedness, noncredit, 30 lec. hours (Offered as needed)**

Skills needed for riot and disturbance control and fire-fighting are studied and practiced. Lecture includes methods of riot prevention, handling of unusual occurrences, what to do if taken hostage, and emergency procedures. Objectives are addressed as specified by the Criminal Justice Standards and Training Commission.

**CJD 0742****Correctional Operations, noncredit, 60 lec. hours (Offered as needed)**

The operation of correctional facilities is studied – including the intake of new inmates, all aspects of their daily care, institutional procedures, and techniques utilized by officers to do daily tasks. Objectives are addressed as specified by the Criminal Justice Standards and Training Commission.

**CJD 0934****Crime Reduction, 45 class hours, 4.5 c.e.u.'s (Offered as needed)**

A course in crime prevention as it exists today in America. Study includes residential, personal and commercial crime prevention and it includes crime prevention resources, crime analysis and current legal implication. Designed primarily for in-service law enforcement officers but will not be limited to such personnel.

**EVS 0635****Environmental Health and Safety, noncredit, 40 lec. 5 lab. (Offered as needed)**

The OSHA Environmental Health and Safety Course is required before entering or working on a hazardous waste site. This course offers an overview of accepted technologies for health and safety issues associated with hazardous materials handling. The emphasis of the course is on personal safety and includes topics such as site hazards, toxicology, personal protective equipment, emergency response operations, and field exercises.

**XXX 6700****Chemical Tests for Intoxication, 40 class hours, 4 c.e.u.'s (Offered as needed)**

Background and history of alcoholic; effects on motor coordination; operation and maintenance of breathalyzer equipment; court testifying; metric systems; and legal aspects of consent law.

**XXX 6702****Criminal Identification, 16 class hours. (Offered as needed)**

Criminal identification techniques utilizing the Identikit in building facial composites of wanted and missing persons. Development of identification — Modus Operandi file system.

**XXX 6704****Police Officer Auxiliary Recruit Course, 97 class hours. (Offered as needed)**

A course designed to meet Florida Police Auxiliary officer minimum standards for certification.

**XXX 6705A****Chemical Test for Intoxication-Annual Requalification Course, 8 class hours, .8 c.e.u.'s (Offered as needed)**

Course meets Florida Department of Education annual recertification of chemical tests for intoxication permits.

**XXX 6709****Auto-Intoximeter Course, 8 class hours, .8 c.e.u.'s (Offered as needed)**

Auto-intoximeter operators course to include instrument familiarity and checkout. Required by State Department of Health for Intoximeter Operations. Prerequisites: State Certified Chemical Tests for Intoxication Operators.

**XXX 6710**

**Police Radar Operator, 40 class hours, 4 c.e.u.'s (Offered as needed)**

This course is sanctioned by the Florida Police Standards and Training Commission and meets requirements of Chapter 943.14(10)(a), Florida Statutes. It is designed to equip law enforcement officers with basic knowledge and skills needed for proper operation of radar speed measurement devices.

**XXX 6806**

**Police Skills, 45 class hours, 4.5 c.e.u.'s (Offered as needed)**

A skills development course designed to upgrade the auxiliary and/or inservice police officer in the areas of driver improvement, arrest techniques, stress reduction, medical emergencies and use of firearms. A Florida Police Standards Salary incentive course.

**XXX 6851**

**Criminal Justice Basic Training, 327 class hours, 32.7 c.e.u.'s (Offered as needed)**

Meets the Florida Standards for Law Enforcement or Corrections certification. Student must complete 160 hours of common core courses as follows: H. Introduction to Criminal Justice (45 hours), I. Criminal Law (45 hours), G. Advanced Firearms (39 hours), P. Basic Skills (31 hours). Police candidates must complete; J. Criminal Investigation (45 hours), K. Police Operations (45 hours), L. Traffic (45 hours), S. Enforcement Skills (32 hours). Corrections candidate must complete: Q. Correctional Skills (70 hours), M. Correctional Law (45 hours), and N. Correctional Operations (45 hours).

## SCIENCES – Biological

### CREDIT COURSES

**BOT 1010C**

**Botany, 4 semester hours, 45 lec., 45 lab. (Spring)**

A course designed to introduce the student to the biological principles of the plant kingdom with emphasis on the flowering plants.

**BSC 1001**

**Review of Biology Fundamentals, 3 semester hours (Offered as needed)**

Fundamentals principles of biology. Vocabulary pertaining to biology of plants, animals, and mankind. Conservation and human ecology.

**BSC 1005**

**General Biology, 4 semester hours, 60 lec. (Fall, Spring, Summer)**

The principles of biology are included. Human Biology is emphasized. Man's effect on the environment is considered wherever appropriate. (NO LABORATORY — Not for majors in Biology).

**BSC 1005L**

**Biology Lab, 1 semester hour, 30 lab. (Offered as needed)**

Laboratory for general biology. Experimental methodology and technique. Not recommended for biology majors. Pre- or corequisite: BSC 1005 or equivalent.

**BSC 1030C**

**Man and Environment, 4 semester hours, 60 lec. (Summer)**

A study of the physical and biological environment and man's ecology with emphasis on contemporary biological problems.

**BSC 1085C**

**Anatomy & Physiology I, 4 semester hours, 45 lec., 30 lab. (Fall, Spring, Summer)**

A study of the human organism to include cells, tissues, skeleton, muscular system, nervous system and gastrointestinal system.

**BSC 1086C**

**Anatomy & Physiology II, 4 semester hours, 45 lec., 30 lab. (Fall, Spring, Summer)**

A study of the human organism to include the cardiovascular system, the fluid electrolyte balance, and the respiratory, excretory, endocrine and reproductive systems. Prerequisite: BSC 1085C.

**BSC 1905**

**Independent Study-Biology, 1 semester hour (Fall, Spring, Summer)**

A course designed to (1) allow a student to complete part of a course taken elsewhere and thereby complete general education requirements, (2) to go deeper into special areas of interest.

**HUN 2001**

**Nutrition, 3 semester hours, 45 lec. (Fall, Spring, Summer)**

The role of nutrients in maintenance of physiological well-being. Application of nutrition principles to the individual and family as well as to some selected problems.

**MCB 1000C**

**Microbiology, Allied Health, 4 semester hours, 45 lec., 30 lab. (Fall, Spring, Summer)**

This course is designed for students entering programs in the numerous health fields, but primarily for pre-nursing students. The material presented covers the fundamentals of microbiology needed to understand the biology of infectious diseases and the agents that cause them. Not accepted as satisfying requirements for majors in biology, premed, prevet, and predentistry.

**MCB 2013C**

**Microbiology, 4 semester hours, 30 lec., 60 lab. (Offered as needed)**

A fundamental course in microbiology designed to fulfill the needs of pre-med., nursing and pharmacy students as well as science majors. A general survey of microbiology, the cultivation and observation of microorganism and their chemical and biological relationships to water, food, industrial processes and disease. Prerequisites: BOT 1010C, ZOO 1010C, and CHM 1045C (May be taken concurrently).

**PCB 2011C**

**Cell Biology, 4 semester hours, 45 lec., 45 lab. (Fall, Spring, Summer)**

A study of the cell as the basic unit of organic structure and function with the emphasis on understanding the complexity and versatility of the cell and its activities. Prerequisite: One year of high school chemistry or CHM 1020.

**ZOO 1010C**

Zoology, 4 semester hours, 45 lec., 45 lab. (Fall, Spring, Summer)

The concepts of animal life. An introduction to the tissues in higher animals, embryology and relationships of major animal phyla to each other and to man.

**SCIENCES – Biological**
**NONCREDIT COURSES**

For information on Continuing Education Units, see page 87.

**XXX8609**

Green Thumb, 20 class hours, 2 c.e.u.'s (Offered as needed)

"Green Thumb" is designed to make each student cognizant of the main principles of plant selection and care. (Self-Supporting course.)

**SCIENCES – Physical**
**CREDIT COURSES**
**AST 1002**

Astronomy, 3 semester hours, 45 lec. (Spring)

Lectures and demonstrations designed to partially meet the general education requirements in physical sciences for nonscience majors. Recommended for students who need a preparatory course prior to taking physics and as a scientific elective in related scientific fields.

**CHM 1020**

Chemical Science, 4 semester hours, 60 lec. (Fall, Spring, Summer)

Fundamental principles and theories of the dual nature of physical existence, matter and energy; atomic theory; periodicity of elements; dependence of properties on structure; kinetic molecular theory; the nature of chemical bonding. Meets graduation requirements for programs other than science and mathematics.

**CHM 1045C**

College Chemistry 1, 4 semester hours, 45 lec., 45 lab. (Fall, Spring, Summer)

Quantitative approach to modern theoretical and physical chemistry, with appropriate development of laboratory techniques. Logical treatment of experimental data leading to understanding of (1) particulate, electrical nature of matter and bonding, (2) periodicity of properties of the elements, and (3) relationships of properties to structure. For science majors, premedical, pre-engineering students and others who have acceptable backgrounds in chemistry and math. Prerequisite: MAC 1102.

**CHM 1046C**

College Chemistry II, 4 semester hours, 45 lec., 45 lab. (Fall, Spring, Summer)

Continuation of CHM 1045C: Solutions, chemical equilibrium and qualitative analysis. Electrochemistry, radiation chemistry and hydrocarbons.

**CHM 2210C**

Organic Chemistry I, 4 semester hours, 45 lec., 45 lab (Offered as needed)

Hydrocarbons, stereochemistry, molecular structure, and reaction mechanisms. Prerequisite: CHM 1045C and 1046C or equivalent.

**CHM 2211C**

Organic Chemistry, 4 semester hours, 30 lec., 30 lab. (Offered as needed)

In continuation of Organic Chemistry I (CHM 2210) the relationships between functional groups and properties of organic compounds will be discussed. Infrared -, NMR-, and mass spectroscopy will be used for identification of organic compounds and for structure analysis. The transition state theory is applied to interpret the nucleophilic addition reactions the carbanion condensation reactions, the interconversions of carbonyl compounds and the nucleophilic acyl substitution of carboxylic acids and their derivatives. Biochemical topics, i.e. lipids, carbohydrates, amino acids and proteins are included. Prerequisite: CHM 2210C

**GLY 1001**

Earth Science, 4 semester hours, 60 lec. (Fall, Spring, Summer)

Survey of processes, materials and structure of the solid earth, oceanography, meteorology, and the relation of the earth to other planets. Intended for physical science general education requirement. Practical exercises in mineral and rock identification.

**GLY 1001L**

Earth Science Lab, 1 semester hour, 30 lab. (Fall, Spring, Summer)

Laboratory experiences pertaining to the physical environment: observation, measurement, data analysis, mapping, map interpretation, properties of earth materials. This is an optional course serving students who transfer to universities which require a laboratory course to satisfy the General Education requirement in Physical Science. Pre- or corequisite: GLY 1001 or equivalent.

**GLY 1010C**

Physical Geology, 4 semester hours, 45 lec., 30 lab. (Offered as needed)

A study of the materials, surface feature, structure and processes of the solid earth. Labs in identification of rocks and minerals. Landforms will be analyzed from topographic and geologic maps. Actual landforms and processes will be studied on field trips and exercises.

**GLY 1100C**

Historical Geology, 4 semester hours, 45 lec., 30 lab. (Offered as needed)

A study of the history of the earth, including the origin of continents, mountains and ocean basins as recorded in rocks and fossils. A survey of the fossil record and changes in animal and plant life throughout geological time will also be studied. Prerequisite: GLY 1001 or equivalent (a physical geology course).

**MET 1010**

Introduction to Meteorology, 3 semester hours, 45 lec. (Fall, Spring)

Structure of the atmosphere, weather processes, systems and phenomena; climate and climatic change, economic impact of weather.

**MET 1010L****Meteorology Lab, 1 semester hour, 30 lab. (Fall, Spring, Summer)**

Laboratory experiences pertaining to the physical environment: observation, measurement, data analysis, mapping, map interpretation, properties of earth materials. This is an optional course serving students who transfer to universities which require a laboratory course to satisfy the General Education requirement in Physical Science. Pre- or corequisite: MET 1010 or equivalent.

**OCE 1005****Introduction to Oceanography, 3 semester hours, 45 lec. (Fall, Spring)**

A survey of the geography, chemistry, physics, and geology of the oceans. Lectures, demonstrations, and laboratory-type exercises to acquaint the students with oceanographic operations and data. No prerequisite.

**OCE 1005L****Oceanography Lab, 1 semester hour, 30 lab. (Fall, Spring, Summer)**

Laboratory experiences pertaining to the physical environment: observation, measurement, data analysis, mapping, map interpretation, properties of earth materials. This is an optional course serving students who transfer to universities which require a laboratory course to satisfy the General Education requirement in Physical Science. Pre- or co-requisite: OCE 1005 or equivalent.

**PHY 1020****Physical Science, 4 semester hours, 60 lec. (Fall, Spring, Summer)**

A one semester course of lectures and demonstrations designed (1) to meet the general education requirement in physical science for nonscience majors and (2) for students who need a preparatory course prior to taking physics. The course presents the fundamental classic and modern concepts of physics in the areas of mechanics, energy, wave motion, electromagnetism, and atomic structure.

**PHY 1053C****Physics I, 4 semester hours, 45 lec., 45 lab. (Offered as needed)**

The first half of a two semester sequence of noncalculus physics designed for the nonphysical science major. Physics I covers the areas of mechanics, mechanical energy, temperature and heat. The entering student is assumed to have a working knowledge of basic algebra and trigonometric functions.

**PHY 1054C****Physics II, 4 semester hours, 45 lec., 45 lab. (Offered as needed)**

The second half of a two semester sequence of noncalculus physics designed for the nonphysical science major. Physics II covers the areas of electricity, magnetism, light, quantum theory, atomic and nuclear structure, and elementary nuclear processes. Prerequisite: PHY 1053C or equivalent.

**PHY 2021****Modern Physics, 3 semester hours, 45 lec. (Summer)**

This course will study topics in the physics of the twentieth century. The student will be introduced to basic quantum mechanics, including Bohr Theory of the atom, the Schroedinger Equation, molecular structure, radiation, and x-ray spectra. Also, the student

will be introduced to solid state physics and electronics, statistical mechanics and atomic and nuclear physics. Intended for science and engineering students and physics majors. Prerequisite: PHY 2048C.

**PHY 2048C****College Physics I, 4 semester hours, 45 lec., 45 lab. (Offered as needed)**

The first half of a two semester sequence designed for majors in engineering, math and the physical sciences. Physics I covers the areas of mechanics, mechanical energy, heat, thermodynamics, and mechanical waves. Calculus is used when feasible. Prerequisite: MAC 1411.

**PHY 2049C****College Physics II, 4 semester hours, 45 lec., 45 lab. (Spring, or as needed)**

The second semester of a two semester sequence designed for majors in engineering, math and the physical sciences. Physics II covers the areas of electricity, magnetism and optics. Calculus is used where feasible. Prerequisite: PHY 2048C or equivalent.

**PSC 2905****Independent Study-Physical Science, 1 semester hour, 45 hours. (Fall, Spring, Summer)**

Directed study and individual projects designed to meet the needs of students interested in a specialized area of the physical sciences for which present course availability is limited.

**SOCIAL SCIENCE****CREDIT COURSES****AMH 1041****American Civilization, 3 semester hours, 45 lec. (Offered as needed)**

Unified history of social and intellectual issues. A study of major American concerns and issues, the proposals, their formative ideas, the resolution attained in an emerging pattern of American character and heritage.

**AMH 2010****American History I, 3 semester hours, 45 lec. (Fall, Spring, Summer)**

American History to 1865; describes the social, political, and economic development of the American people against the geographical background of the New World. Particular emphasis on American intellectual and political thought leading to the emergence of basic American character, ideas and attitudes.

**AMH 2020****American History II, 3 semester hours, 45 lec. (Fall, Spring, Summer)**

American History from 1865, concentrating on industrial growth, the rise of corporate business, big labor, and government organization. Modification of basic American character and ideas as a continual historical process.



**AMH 2071****Survey of Early History of Florida, 3 semester hours, 45 lec. (Offered as needed)**

A survey of Florida history from pre-Columbian populations through the Territorial Period.

**ANT 2000****Introduction to Anthropology, 3 semester hours, 45 lec. (Offered as needed)**

Introduction to the fundamental principles, concepts, methods and theories in Anthropology. Includes a brief introduction to the subdisciplines of Anthropology: Cultural Anthropology, Physical Anthropology, Archaeology, and Linguistics. A cross-cultural perspective will be paramount in the study of Anthropology.

**ANT 2100****Introduction to Archaeology, 3 semester hours, 45 lec. (Offered as needed)**

Introduction to the fundamental principles, methods, and theories in Archaeology. Includes a history of the development of Archaeology, and examination of the nature of Archaeological data and research, an introduction to archaeological data and analysis, and an examination of approaches to synthesis and interpretation. North and South American archeology is studied, but nonwestern examples are also studied to enhance an understanding of the development of the discipline in Europe and the Americas.

**ANT 2310****Introduction to North American Indians, 3 semester hours, 45 lec. (Offered as needed)**

Historical survey of Native American cultures north of Mexico. Includes study of prehistoric cultures and culture areas; present day Native American cultures; and political and economic issues relating to Native Americans.

**ANT 2930****Special Topics in Anthro/Archaeology, 3 semester hours, 45 lec. (Offered as needed)**

Introduction to special topics in anthropology and archaeology. Example: Survey and introduction to prehistoric and early historic Native American cultures in Florida and the Southeast U.S.

**CLP 1002****Personal Adjustment, 3 semester hours, 45 lec. (Fall, Spring, Summer)**

Psychology of adjustment, application of psychological theory for problem solving and better mental health. An examination of psychological defense mechanisms and adaptive behavior.

**CLP 2140****Abnormal Psychology, 3 semester hours, 45 lec. (Offered as needed)**

A study of the different problems in psychopathology, including anxiety, depression, social deviance, psychosis, schizophrenia, both child and adult, mental retardation and general brain dysfunction, with emphasis on descriptive etiology, known causes, and treatments.

**DEP 2004****Human Growth and Development, 3 semester hours, 45 lec. (Fall, Spring, Summer)**

A research oriented course in human development, covering the life span of the human being from conception to death. Special emphasis placed upon the interrelationships of the stages of development of the normal person.

**EDF 1005****Introduction to Education, 3 semester hours, 45 lec. (Fall, Spring, Summer)**

A study of the history, philosophy and social context of education. The course will help the student think critically about the process of education and his/her role as an educator. Student will observe and participate in the educational settings of local schools.

**EDP 2002****Educational Psychology, 3 semester hours, 45 lec. (Fall, Spring, Summer)**

Significant aspects of the growth and development of children and youth, including physical, social, and intellectual developments as they affect behavior patterns. Psychology as applied in improving the learning process.

**EEX 2010****Introduction to Exceptional Children, 3 semester hours, 45 lec. (Offered as needed)**

Study of incidence, nature, etiology and services available in connection with exceptional children including: hearing and speech problems; learning disabilities, mental retardation, blind, physically handicapped, gifted, emotional conflicts, also parents of exceptional children. Prerequisites: PSY 2012 or equivalent.

**GEO 1000****World Regional Geography, 3 semester hours, 45 lec. (Offered as needed)**

The course introduces the student to geographic regional studies. It will combine the concepts of physical geography and cultural or human geography as it applies to the differing regions of the world. It will show the relationship between the following: (1) regional environment and the peoples who live there and (2) settlement patterns, economic and cultural patterns within each region. Using current events, the course will show the impact of other phenomena upon those regions and their peoples.

**INR 1065****War and Civilization, 3 semester hours, 45 lec. (Offered as needed)**

An analytical and historical study of warfare from its earliest beginnings to the present day stressing the impact of war on the social, economic, and political structure of civilization.

**INR 2002****Current World Problems, 3 semester hours, 45 lec. (Summer)**

Critical world issues and immediate troubled areas against a historical, political, economic, and social background as an introduction to international relations. The individual student develops a special area of interest to explore in-depth the principles of international relations after their instruction.

**INR 2270**

**Study Abroad – Introduction to International Studies, 3 semester hours, 30 lec., 45 lab. (Offered as needed)**

A variable content course designed to allow students first-hand learning experiences around the world. Initial classroom hours on campus will give students general background information on the country (ies) to be visited. Foreign countries become, in effect, laboratories. Students will gain a broader vision of world societies through exposure to foreign culture, political, economic systems. Provides a broad overview of major nations and how they relate to each other as well as their impact on the international balance of power.

**ISS 1905**

**Independent Study – Social Science, 1 semester hour, 45 hours (Offered as needed)**

Directed study and individual projects designed to meet the needs of students interested in a specialized area of the social sciences for which present course availability is limited.

**ISS 2905**

**Directed Work Study – Social Science, 1 semester hour, 45 hours (Offered as needed)**

Entry by permission of department chair only.

**ISS 2943**

**Tutorial-Social Studies, 1 semester hour, 30 hours (Fall, Spring, Summer)**

An experience in individual depth study in which one student prepares for and engages in tutoring another for two class periods per week. Prerequisite: Departmental permission.

**POS 1041**

**American Government, 3 semester hours, 45 lec. (Fall, Spring, Summer)**

Examines government, political ideals, and institutions. Strong emphasis is placed on political thought, the origin of the American federal system, and the distribution of powers between state and national governments.

**POT 1002**

**History and Ideas of Political Science, 3 semester hours, 45 lec. (Offered as needed)**

This course reviews classical ideas, political theory and institutions from a historical and comparative viewpoint. It examines the rise of the State, its organization, economic systems, the use of force, and persuasion.

**PSY 2012**

**Psychology, 3 semester hours, 45 lec. (Fall, Spring, Summer)**

Surveys of the various fields of psychology. Understanding human behavior by studying the adaptation of the individual to the physical and social environment.

**SOP 2740**

**Psychology of Women, 3 semester hours, 45 lec. (Offered as needed)**

An in-depth survey of the various areas of study in the psychology of the female experience.

**SYG 2000**

**Sociology, 3 semester hours, 45 lec. (Fall, Spring, Summer)**

Concentrates on the description of individual and group behavior. Basic concepts are related to the family and the city, individual, industrial, and political problem areas.

**SYG 2010**

**Social problems, 3 semester hours, 45 lec. (Offered as needed)**

Introduction to the sociological study of the nature of social problems to insure understanding of their impact on the individual, the group and social institutions in societal and cultural settings.

**SYG 2430**

**The Family and Society, 3 semester hours, 45 lec. (Offered as needed)**

An examination of the problems which arise out of participation in marriage, family and community situations. Designed to provide students with a basic understanding of the dynamics of family interaction, the effects upon the children, and the family's relationship to and participation in the community.

**WOH 1012**

**World Civilization I, 3 semester hours, 45 lec. (Fall, Spring, Summer)**

A study of world history from 4000 BC to 1650 AD as it relates to the development of western civilization. History is analyzed in terms of social, religious, philosophical, political, and economic concepts rather than chronological facts.

**WOH 1022**

**World Civilization II, 3 semester hours, 45 lec. (Fall, Spring, Summer)**

A study of history from 1650 AD to the present as it relates to the development of the modern world. History is analyzed in terms of social, religious, philosophical, political, and economic concepts rather than chronological facts.

**WOH 2040**

**Twentieth Century, 3 semester hours, 45 lec. (Summer)**

International political and historical affairs in the twentieth century through the institutions and organizations of the Western State System. Attention is on international cooperation, decision making, force, world resources, and world political geography by the selection of a specific problem.



*Members of the OWCC Brain Bowl Team proudly display awards won at one of their many successful matches.*

# PERSONNEL LISTING

## **DISTRICT BOARD OF TRUSTEES**

Eileen H. Arpke, 1994  
Eltse B. Carter, 1995  
Walter B. (Mike) Hill, 1997  
Robert L. Ignasiak, 1994  
James E. King, 1994, Vice Chairman  
C. Jeffrey McInnis, 1995, Chairman  
Sally R. Merrifield, 1997  
Elena M. Roser, 1997  
Joseph D. Lorenz, Attorney for the Board  
James R. Richburg, Corporate Secretary

## **OFFICE OF THE PRESIDENT**

James R. Richburg, President  
A.A. — Columbus College  
B.S., M.A., Ed.D. — University of Georgia  
Carolyn Laux, Executive Secretary to the President  
Certificate — OWCC  
Edna Washington, Secretary III  
James P. Chitwood, Director, Institutional Resource  
Development  
A.A. — Okaloosa-Walton Community College  
B.A. — Saint Leo College  
M.P.A. — University of West Florida  
Lester S. Smith, Director of Media/Public Relations  
B.S. — Texas A&M  
M.S. — Boston University  
Sylvia P. Bryan — Coordinator of Media &  
Public Relations  
B.S. — Florida State University  
Becky Tislow, Secretary II  
A.A. — Okaloosa-Walton Community College

## **OFFICE OF INSTRUCTIONAL SERVICES**

James A. Durham, Vice President for Instruction  
B.S., M.S. — University of Tennessee  
Ed.D. — University of Southern Mississippi  
Patricia Belote, Secretary III  
A.A. — Okaloosa-Walton Community College  
Charlotte McDonald-Williams, Administrative Assistant  
A.S. — Okaloosa-Walton Community College

## **DIVISION OF HUMANITIES, FINE AND PERFORMING ARTS**

Clifford Herron, Division Director/Instructor in Humanities  
A.A. — Lake Michigan College  
B.S., M.A. — Western Michigan University  
Ph.D. — Florida State University  
Mary Lou Baker, Secretary II  
Henry "Bernie" Bell, Instructor, Music Theory,  
Jazz Band, Art  
B.F.A. — University of Georgia  
Arnold Hart, Instructor, Humanities and Studio Art  
B.F.A., M.Ed. — University of Florida

Guy Heath, Instructor  
B.A. — Southern California College  
M.A. — University of West Florida  
John G. Leatherwood, Instructor, Humanities and Music/  
Director, Chorus & Orchestra  
B.M. — Mars Hill College  
M.M. — George Peabody College for Teachers of  
Vanderbilt University  
David Owens, Instructor, Humanities and Studio Art  
B.S., M.F.A. — Florida State University  
Walter B. Shipley, Instructor, Humanities/Director  
of Theatre  
B.S. — Bethel College  
M.A. — Memphis State University  
D. Ann Waters, Instructor  
A.A. — Chipola Junior College  
B.A. — University of West Florida  
M.A. — University of South Alabama

## **DEPARTMENT OF COMMUNICATIONS**

Margaret A. Crozier, Chairman/Instructor, Speech and  
English  
B.A., M.A. — Louisiana Technical University  
Margaret Hitchings, Secretary II (Communications and  
Social Science)  
Diana Chipps, Office Worker  
Myrtle B. Beavers, Instructor, English  
A.A. — Okaloosa-Walton Community College  
B.A., M.A., — University of West Florida  
Ph.D. — Florida State University  
Jon Brooks, Instructor, English  
B.A., M.A. — University of South Dakota  
Ph.D. — University of Alabama  
Edwin A. Gardner, Instructor, English and Foreign  
Languages  
B.A. — University of Idaho  
M.A. — University of Oregon  
Jack Gill, Instructor, English  
B.A. — Berea College  
M.A. — Eastern Kentucky University  
Beverly Holmes, Instructor, English  
B.S. — Bowling Green State University  
M.S. — University of Denver  
M.S.E. — University of Central Arkansas  
Dianne F. Kostelny, Instructor, English  
B.S. — Bob Jones University  
M.Ed. — University of Cincinnati  
Julie Nichols, Instructor, English  
B.A., M.A. — University of West Florida  
Sarah Paulk, Instructor, English and Humanities  
A.A. — Okaloosa-Walton Community College  
B.A., M.A., Ph.D., — Florida State University  
Lucia W. Robinson, Instructor, English  
A.B. — Butler University  
M.A. — Duke University

### **Department of Communications, continued**

- Ann Southard, Instructor, English  
B.A., M.A. — University of West Florida
- James Suderman, Instructor, English/Coordinator,  
Academic Success Center  
B.A. — Earlham College  
M.A. — South Dakota State University
- Lulu S. Watson, Instructor, Reading  
B.A. — University of West Florida  
M.S. — Troy State University
- Joy P. Yamall, Instructor, English  
B.S. — University of Alabama  
M.A. — University of West Florida

### **DEPARTMENT OF MATHEMATICS**

- Mary L. Henderson, Department Chair/Instructor,  
Mathematics  
B.A., M.A.T. — University of West Florida
- Karen Baker, Instructor, Mathematics  
A.A. — Chipola Junior College  
B.A., M.A. — University of West Florida
- Douglas Dunbar, Instructor, Mathematics  
B.S. — Auburn University  
M.A. — California State University
- Peter Falzone, Instructor, Mathematics  
A.A. — Pensacola Junior College  
B.S., M.S.T. — University of Florida
- Shirley Howard, Instructor, Mathematics  
B.S., M.S. Texas Technological University
- Guangyu Liu, Instructor, Mathematics  
M.S. — Nanjing University - China  
Ph.D. — University of Connecticut
- Victoria Martinez, Instructor, Mathematics  
B.S. — University of Florida  
M.S. — Florida State University
- Robin Charles Olmstead, Instructor, Mathematics  
B.S., M.S.T. — Georgia Southern College
- Deepankar Pal, Instructor, Mathematics  
B.A. — Huntingdon College  
M.S., M.Ed., Ed.S. — Alabama State University
- Julia K. Polk, Instructor, Mathematics  
B.S. — Southeastern Louisiana University  
M.S. — Clemson University
- David Vaughan, Instructor, Mathematics  
B.S., M.S. — University of Wyoming

### **DEPARTMENT OF SCIENCES**

- Ross E. Hamilton, Chairman/Instructor, Biology  
B.S. — William Carey College  
M.S. — Northeast Louisiana State University
- Roger Adams, Instructor, Biology  
B.S., M.S., Ph.D. — Florida State University
- Jonathan R. Bryan, Instructor, Earth Science/Geology  
B.S. — Florida State University  
M.S. — University of Florida  
Ph.D. — University of Tennessee
- Ronald A. Head, Instructor, Physical Science,  
Chemistry  
B.S. — Birmingham-Southern College  
M.A. — University of Alabama  
Ph.D. — University of the Pacific

- Darryl Ritter, Instructor, Biology  
B.S. — University of Illinois  
M.S., Ph.D. — Southern Illinois University
- Anthony Russo, Instructor, Physical Science, Physics  
A.A. — Miami-Dade Community College  
B.S., M.S. — Florida Atlantic University
- Roswitha Zimmer, Instructor, Physical Science,  
Chemistry  
B.S. — University Regensburg, West Germany  
M.S., Ph.D. — Technical University, Munich,  
West Germany

### **DEPARTMENT OF SOCIAL SCIENCE**

- Joyce Goldstein, Department Chair/Instructor  
B.A. — University of South Florida  
M.A. — Our Lady of the Lake University  
Ph.D. — St. Louis University
- Margaret Hitchings, Secretary II (Communications and  
Social Science)
- Wendell Griffith, Instructor, Social Science  
B.A. — Louisiana Tech University  
M.A. — University of West Florida
- Cecilia Rivers, Instructor, Sociology  
B.S. — Alabama State University  
M.A. — University of South Alabama
- Edward T. Scofield, Instructor, Social Science  
A.A. — Okaloosa-Walton Community College  
B.A., M.A., — Eastern Washington University
- Ronald Senzig, Instructor, Social Science  
B.S., M.A. — Indiana State University
- Mary L. Stegall, Instructor, Social Science  
B.S. — Furman University  
M.S., Ph.D. — University of North Carolina

### **DEPARTMENT OF ATHLETICS & PHYSICAL EDUCATION**

- Michael "Mickey" Englett, Chairman/Athletic Director  
B.S., M.A. — University of South Alabama  
M.S. — University of West Florida
- Dot Carter, Secretary II
- Johnny Matthews, Office Worker
- Murray Arnold, Head Men's Basketball Coach  
B.A. — American University  
M.A. — Stetson University
- David Garner, Head Baseball Coach  
A.A. — Martin Junior College  
B.S., M.S. — Middle Tennessee University
- Keith Griffin, Assistant Baseball Coach  
B.S. — Livingston University  
M.A. — University North Alabama
- Lanny R. Heath, Instructor, Health and  
Physical Education/Coordinator, Wellness Center  
A.A. — Georgia Southwestern Junior College  
B.S. — Georgia Southern College  
M.A. — George Peabody College
- Frances S. Herron, Instructor, Dance  
B.F.A., M.F.A. — Florida State University

**Department of Athletics & Physical Education**  
*continued*

Marty L. Pump, Head Women's Softball Coach  
B.A., M.A. — University of Iowa  
Charles H. Pulley, Instructor, Health and Physical Education  
B.S.R., M.P.E. — University of Florida  
Cheryl Rice, Head Women's Basketball Coach  
B.S., M.Ed. — University of South Alabama  
Adrien Shuler, Assistant Women's Basketball Coach  
B.S. — University of Georgia  
Barry Taylor, Assistant Men's Basketball Coach

**OFFICE OF TECHNICAL EDUCATION**

Ned R. Couey, Dean of Technical Education  
B.S. — Bryan College  
M.A. — University of South Florida  
Ed.D. — Auburn University  
Pam Koch, AHEC Center Director  
B.A. — Huntingdon College  
M.S. — University of Georgia  
Linda Jones, AHEC/Secretary II  
Patricia Mann, Office Specialist  
Certificate — Okaloosa-Walton Community College  
Rebecca Burgess, Grant Coordinator  
A.A. — Okaloosa-Walton Community College  
B.S., M.P.A. — University of West Florida  
Carol Karlson, Educational Advising  
B.A. — Emory University

**DIVISION OF PUBLIC SAFETY**

Instructor/Coordinator of Public Safety  
Secretary II  
Reca René Chamberlain, Instructor  
A.A. — Okaloosa-Walton Community College  
B.S. — Florida State University  
J.D. — Mississippi College School of Law  
William Grigsby, Instructor, Public Safety  
A.S. — Okaloosa-Walton Community College  
B.S., M.S.P.A. — Troy State University  
Virginia Haddad, Instructor  
B.A. — University of Arkansas at Little Rock  
J.D. — College of Law, University of Arkansas at Little Rock  
L.L.M. — George Washington University  
Cecelia Rivers, Instructor, Public Safety  
B.S. — Alabama State University  
M.A. — University of South Alabama

**DIVISION OF BUSINESS & CENTER FOR BUSINESS DEVELOPMENT**

Carolane Williams, Division Director  
A.A. — Olive-Harvey Junior College  
B.A. — Chicago State University  
M.S. — Troy State University  
Donna K. Utley, C.P.A., Interim Department Chair/  
Instructor, Accounting  
B.S. — Texas Technological University  
M.S. — Texas A&M University  
Monette C. Page, Secretary II  
Jay Bhattacharya, Instructor, Economics  
B.A. — Victoria College - India  
M.A. — University of North Bengal  
Ph.D. — University of Illinois  
Natalie E. Edwards, Instructor, Business Education  
B.S. — Fayetteville State University  
M.A. — Ohio State University  
Edward Friese, Instructor, Distributive Education  
A.A. — St. Petersburg Junior College  
B.S. — University of Florida  
M.A.T. — University of South Florida  
Suzanne Gaszak, Educational Advising Specialist  
B.A. — University of West Florida  
James D. Holland, Instructor, Computer Science  
B.S. — Arizona State University  
M.S. — University of West Florida  
Charlotte A. Langley, Instructor, Computer Science  
A.A. — Okaloosa-Walton Community College  
B.S. — University of West Florida  
M.S. — University of Southern Mississippi  
George Lucas, Instructor, Accounting & Statistics  
B.B.A., M.A. — Marshall University  
Juda McAdoo, Coordinator, Career Assessment Center  
B.G.S. — Auburn University  
M.S. — Troy State University  
Joel Perdue, Instructor, Data Processing  
B.E.E. — University of Omaha  
M.B.A. — Midwestern State University  
Riley Perdue, Instructor, Food Service

**DEPARTMENT OF MANUFACTURING & TECHNOLOGY**

Raymond L. Rickman, Chairman/Instructor,  
Drafting/Design  
A.A. — Okaloosa-Walton Community College  
B.S., M.Ed. — University of West Florida  
Robert C. Atwood, Instructor, Graphic Arts  
A.A. — Palomar Junior College  
B.S. — San Diego State University  
M.A. — Michigan State University  
Charles Mass, Instructor, Electronics  
A.S. — Gulf Coast Community College  
B.S., M.Ed. — University of West Florida  
Ron Walls, Instructor, Electronics

## **DIVISION OF CONTINUING EDUCATION & HUMAN DEVELOPMENT**

Marilee C. Whitney, Director/Continuing Education

B.S., M.S., Ed.S. — Florida State University

Phyllis Black, Secretary II

Beverly Sandlin, Coordinator/Instructor, Child  
Development

B.S. — Eastern New Mexico University

M.S. — Northwestern State University

Ed.S. — Florida State University

Johanna Adkins, Coordinator, Single Parent/  
Displaced Homemaker Program

B.S. — Mississippi State University

M.A. — University of Georgia

Janet Moomaw, Child Care Assistant

Certificate in Child Care — Western Oklahoma  
State University

A.A.S. — Okaloosa-Walton Community College

Barbara A. Simshauser, Grant Coordinator

B.S. — University of Akron

M.S. — Troy State University

## **LITERACY CENTER AND ADULT BASIC EDUCATION**

Barbara M. Jones, Director

B.S. — Tennessee Technological University

M.A. — University of West Florida

Penny Cox, Grant Coordinator

B.A. — Coker College

Nancy DiBattista, Staff Assistant/Volunteer Coordinator

B.A. — Wright State University

M.S. — Troy State University

Doris L. Johnson, Instructor, Adult Basic Education

B.S., M.Ed. — Florida A&M University

Dianne F. Kostelny, Coordinator - ABE,

Instructor, Communications

B.S. — Bob Jones University

M.Ed. — University of Cincinnati

## **OFFICE OF STUDENT SERVICES**

AnnaBelle D. James, Dean of Student Services/Registrar

A.A. — Okaloosa-Walton Community College

B.A., M.A. — University of West Florida

Kim Gibson, Secretary II

Dianne Faith Avillion, Counselor/Coordinator of  
Aids, Alcohol and Drug Abuse Education

B.A. — Mansfield State College

M.Ed., Ed.S. — University of Florida

Barbara Bishop, Advising Specialist

A.A. — Okaloosa-Walton Community College

Sue T. Bridges, Counselor/Coordinator of Testing

B.S. — Eastern New Mexico University

M.Ed. — Trinity University

Ph.D. — Texas A&M University

Gaius Bruce, Instructor, Coordinator of Student Activities

B.S., M.S. — Memphis State University

Josette Home, Secretary I (Career Information Center)

Faye Golding, Secretary I, Student Activities

A.A. — Midland Technical College

Jody Swenson, Counselor/Coordinator of Services to  
Students with Special Needs

B.S. — Florida International University

M.S. — Troy State University

Lois Webb, Advising Specialist

A.A. — Okaloosa-Walton Community College

B.S. — University of West Florida

## **OFFICE OF FINANCIAL AID**

Christine C. Bishop, Director of Financial Aid

A.A. — Alpena Community College

B.S. — Troy State University

M.S. — Central Michigan University

Joan Baldwin, Financial Aid Specialist I/Fiscal Operations

A.A. — Okaloosa-Walton Community College

B.A. — University of West Florida

M.P.A. — Troy State University

Janice M. Coon, Financial Aid Specialist II/Scholarships  
and Student Employment

A.A. — Ball State University

B.A. — St. Leo University

Shari Forfa, Financial Aid Specialist I/Loan Officer

A.A. — Okaloosa-Walton Community College

B.S. — University of West Florida

Carmen Sanders, Financial Aid Specialist I/Pell Grant

B.A. — MaryKnoll College

## **OFFICE OF ADMISSIONS AND REGISTRATION**

AnnaBelle D. James, Dean, Student Services/Registrar

A.A. — Okaloosa-Walton Community College

B.A., M.A. — University of West Florida

Amy Rudolph Junger, Secretary II

Lorraine Davis, Office Worker

Aleane Huntington, Office Worker

A.S. — Okaloosa-Walton Community College

Carla Martin — Office Worker

A.A. — Okaloosa-Walton Community College

B.S. — University of West Florida

Ethel Phelps, Office Manager

Bobbie G. Pride, Office Worker

Doug Savage, Admission and Registration Specialist

A.A. — Okaloosa-Walton Community College

B.S. — Florida State University

M.P.A. — Troy State University

Ed.S. — University of West Florida

## **LEARNING RESOURCES CENTER**

Glenn Triplett, Director

B.A., M.S. — Florida State University

M.S. — Barry University

Judy Holzschuh, Secretary II

Owen Adams, Audio Visual/Cataloging Librarian

A.A. — Gulf Coast Community College

B.A. — Our Lady of the Lake University

M.S.L.S. — Florida State University

M.B.A. — University of West Florida

Cathy Ervin, Office Worker  
 Janice W. Henderson, Cataloging/Circulation Librarian  
 B.S. — Spring Hill College  
 M.S.L.S. — University of North Carolina  
 Pamela R. Hynes, Office Worker  
 B.A. — Central Michigan University  
 Allon Ison, Office Worker  
 A.A.S. — Okaloosa-Walton Community College  
 Elizabeth Lilley, Office Worker  
 Edward M. Livingston, Jr., Media Services Manager  
 A.A. — Okaloosa-Walton Community College  
 Sandra MacDonald, Office Worker  
 Margaret T. Phillips, Acquisitions Librarian  
 A.A. — Emory-at-Oxford  
 B.A. — University of Georgia  
 M.A.L.S. — Emory University  
 Hosmer W. Roberson, Periodicals/Reserve Librarian  
 B.S. — University of Alabama  
 M.S. — University of Southern Mississippi  
 Michael Yeager, Office Worker  
 A.A. — Okaloosa-Walton Community College

## **OWCC CENTERS**

### **CHAUTAQUA CENTER**

Barbara M. Jones, Director  
 B.S. — Tennessee Technological University  
 M.A. — University of West Florida  
 Cheryl Klava, Secretary I  
 Tammy D. Lawrence, Secretary II  
 Judy J. Metzger, Advising Specialist  
 A.A. — Okaloosa-Walton Community College  
 Aubrey "Bo" Newberry, Facilities Maintenance Specialist  
 A.A. — Lurleen B. Wallace State Jr. College

### **EGLIN CENTER**

Reate Davis, Director  
 A.A. — Yuba College  
 B.G.S. — University of Nebraska at Omaha  
 M.S. — Troy State University  
 James A. Graham, Educational Advisor  
 A.A. — Okaloosa-Walton Community College  
 B.S. — University of West Florida  
 M.S. — Troy State University  
 Peggy A. Paplauskas, Secretary II

### **OWCC-UWF FORT WALTON BEACH CAMPUS**

David L. Goetsch, Provost  
 A.S. — Pensacola Junior College  
 B.S., M.A. — University of West Florida  
 M.A., M.S. — Troy State University  
 Ed.D. — NOVA University  
 Faye Crawford, Secretary III  
 Joseph Accardi, Trades Specialist  
 Jeanne P. Besse, Secretary II  
 A.A. — Okaloosa-Walton Community College  
 B.A., M.B.A. — University of West Florida  
 Robert Davies, Educational Advisor  
 B.S. — University of West Florida  
 M.S. — Troy State University  
 Charlotte Kelly, Secretary I  
 Jane Maddan — Office Worker  
 A.A. — Okaloosa-Walton Community College  
 Billy Maxcy, Skilled Craftsman

Maxine Randolph, Secretary I  
 A.A., B.A. — St. Leo College  
 Cornell Williams, Custodial Supervisor  
 Inez W. Bailey, Counselor  
 B.S. — Hampton University  
 M.Ed. — Wayne State University  
 Dedria Lunderman, Accountant/Campus Operations  
 Coordinator  
 B.S. — Southern University  
 M.S. — Troy State University  
 Joseph J. Matthews, Instructor, Social Science  
 B.A., M.A. — University of Miami  
 Ph.D. — Kansas State University  
 Cynthia McGinnis, Instructor, Mathematics  
 A.A. — Hillsborough Community College  
 B.A., M.A. — University of West Florida  
 Robert H. Miller, Instructor, Computer Science  
 B.S., M.B.A. — University of West Florida  
 Cheryl C. Powell, Instructor, English  
 B.A. — Auburn University  
 M.A., Ph.D. — Florida State University  
 Louan B. Rathke, Instructor, Health and Physical  
 Education  
 B.A. — Lenoir Rhyne College  
 M.Ed. — University of North Carolina-Greensboro  
 Robert A. Larson, Instructor, Humanities, Philosophy, &  
 Sculpture  
 B.S.S. — Fairfield University  
 M.A. — University of Florida  
 Ph.D. — Florida State University  
 Mona Williams, Instructor, Earth Science, Geology  
 A.S. — George C. Wallace Junior College  
 B.S., M.S. — University of Alabama

### **HURLBURT CENTER**

Gordon L. Jaspersen, Director  
 B.S., M.S. — University of Wisconsin  
 Ed.S. — University of Wyoming

### **ROBERT L.F. SIKES EDUCATION CENTER**

Barbara Jones, Director  
 B.S. — Tennessee Technological University  
 M.A. — University of West Florida  
 Gail C. Kaltz, Vocational Advising Specialist  
 Charles Griffin, Facilities Maintenance Specialist

## **OFFICE OF ADMINISTRATIVE SERVICES**

Jeff Schembera, Vice President for Administrative  
 Services  
 B.S., M.S. — Florida State University  
 Diane Baxter, Secretary III  
 Jennifer Clark, C.P.A., Fiscal Reports Coordinator  
 A.A. — Okaloosa-Walton Community College  
 B.A., M.B.A. — University of West Florida

## **BUSINESS OFFICE**

Kenneth R. Burdzinski, Comptroller  
B.B.A. — Eastern Michigan University  
M.B.A. — Baldwin-Wallace College  
John Agosto, Fiscal Assistant I  
B.S. — Lehman College  
Charles Brocketto, Accountant  
Dena Gamble, Office Worker  
Karyn Heaney, Accountant  
B.S. — University of South Carolina  
Elizabeth W. Kuntz, Fiscal Assistant  
B.A. — University of Cincinnati  
Theresa H. Levesque, Fiscal Assistant II  
Holly Peacher, Accountant  
A.A. — Okaloosa-Walton Community College  
B.A. — University of West Florida  
Louise "Scottie" Thacker, PBX Operator  
Melinda Vanderhoek, Payroll Specialist  
A.A. — Okaloosa-Walton Community College  
Rick Watson, Accountant  
A.A. — Community College of the Air Force  
A.A. — Okaloosa-Walton Community College  
B.A. — Florida State University

## **MANAGEMENT**

### **INFORMATION SYSTEMS**

Donna B. Davis, M.I.S. Director  
B.S. — University of Rhode Island  
Karen Donnelly, Secretary II  
A.A. — Okaloosa-Walton Community College  
Sylvia Caldwell, Programming Supervisor  
A.A. — Okaloosa-Walton Community College  
B.S. — University of West Florida  
James W. Campbell, Computer Operator  
Ken Frazier, Programmer/Analyst  
A.A. — Okaloosa-Walton Community College  
B.S. — University of West Florida  
Mark Hilton, Microcomputer Technician  
A.S. — Community College of the Air Force  
John C. Hutson, Senior Programmer/Analyst  
B.S. — Florida State University  
Elizabeth Morgan, Programmer/Analyst  
A.A. — Okaloosa-Walton Community College  
Galer Nichols, Senior Programmer/Analyst  
A.A. — St. Petersburg Junior College  
B.S. — Tampa State  
Roger Noel, Computer Operations Manager  
Glenn Van Brunt, Programmer/Analyst  
Jimmy Willis, Computer Operator

### **PERSONNEL DEPARTMENT**

William T. Hall, Director of Personnel  
B.S. — Southern Illinois University  
M.S. — Virginia State University  
Carol Hanley, Secretary II  
Nancy Murphy, Personnel Specialist  
A.A. — Okaloosa-Walton Community College

## **PURCHASING, AUXILIARY, AND SUPPORT SERVICES**

N. Richard Stallworth, Director  
B.S. — Louisiana State University  
Tonia E. Lawson, Secretary II  
Gwen J. Street, Staff Assistant/Graphic Services  
A.A., A.S. — Okaloosa-Walton Community College  
Ruben Chandler, Central Services Manager  
A.A. — Okaloosa-Walton Community College  
Margaret R. McDowell, College Store Manager  
B.S. — Elmhurst College  
Riley Perdue, Food Service Manager  
Annette Brault, (Food Service)  
Juanita Chandler, Office Specialist (College Store)  
Theresa A. Comeau, Typesetter (Graphic Services)  
Steve Fielding, Office Worker (Central Services)  
Geraldine Fleming, Office Specialist (Purchasing)  
Donald R. Levesque, Storekeeper (Central Services)  
Certificate — Okaloosa-Walton Community College  
Kathy Newsome, Dishroom Worker (Food Service)  
Christopher Polazzo, Clerk (Food Service)  
Annette B. Roller, Cook (Food Service)  
Donald L. Truitt, Printer (Graphic Services)  
Tammy Van Dyke, Office Worker (College Store)

### **PHYSICAL PLANT**

Warren C. Smith, Director, Physical Plant  
A.A. — Okaloosa-Walton Community College  
B.S. — University of West Florida  
Carl Younger, Assistant Physical Plant Director  
A.A.S. — Community College of the Air Force  
B.S. — University of Maryland  
M.P.A. — Troy State University  
Brenda J. Patten, Secretary II  
A.A. — Okaloosa-Walton Community College  
Murdene Baker, Senior Custodian  
Johnny Bell, Custodial Worker  
William J. Brown, Trades Specialist  
Eric Buharp, Groundskeeper  
Billy H. Butler, Safety Inspector  
Gary Cassell, Custodial Worker  
A.A. — Okaloosa-Walton Community College  
Colandus Chatman, Jr., Custodial Worker  
Ron Currington, Custodial Worker  
Marty Edwards, Groundskeeper  
George Fisher, Custodial Worker  
Robert Freeman, Custodial Worker  
A.A.S. — Community College of the Air Force  
Elbert Gore, Trades Specialist  
Don Grace, Senior Groundskeeper  
Michael J. Hancock, Groundskeeping Supervisor  
Willis Henderson, Custodial Worker  
John Joplin, Custodial Supervisor  
Jimmy E. Land, Skilled Craftsman  
Larry Laux, Groundskeeper  
Jimmy Lawson, Groundskeeper  
Maurice Magourik, Trades Specialist  
Gladys McCormick, Custodial Worker  
Roy McGriff, Custodial Worker  
Chubby Moore, Custodial Worker  
Kevin Moore, Custodial Worker



Tom Morgan, Jr., Custodial Worker  
 A.A.—Tallahassee Community College  
 A.S. — Okaloosa-Walton Community College  
 Douglas Norman, Trades Specialist  
 L. Z. Pritchett, Senior Custodian  
 John Rickard, Skilled Craftsman  
 John R. Roberts, Skilled Craftsman  
 A.A.S. — Okaloosa-Walton Community College  
 Richard Robley, Bus Driver/Vehicle Maintenance  
 James Scott, Custodial Worker  
 Dewey Wells, Skilled Craftsman

## **RETIRED FACULTY AND PROFESSIONAL STAFF**

James Edward McCracken, Ph.D., 1964-1988,  
 President Emeritus  
 Henderson Adams, M.A., 1968-1981  
 Lucile Anderson, M.A., 1964-1972  
 Hilda M. Anger, M.A., 1968-1991  
 Vera Craiger Auerbach, M.A., 1968-1987  
 \* Jack Bartell, M.A., 1964-1971  
 Roby A. Beal, Ed.D., 1967-1988  
 Ernest Beasley, B.A., M.A., 1986-1992  
 Eugene S. Benvenuti, B.S., M.A., 1970-1993  
 Harold Boone, 1972-1987  
 Roy Bundy, Ph.D., 1968-1989  
 Louise Campbell, M.A., 1967-1970  
 Herbert J. Cash, M.S., 1968-1989  
 George Castle, M.A., 1972-1985  
 Leigh Chapman, 1969-1979  
 Grady Clark, 1973-1983  
 Flora Conger, B.S., M.S., Ed.D., 1971-1992  
 Jack Culwell, M.S., 1967-1987  
 \* Fanny-Fern Davis, Ph.D., 1965-1968  
 Dorothy Fernstrom, Ed.D., 1971-1986  
 \* Gerald Fowler, M.B.A., 1973-1988  
 John Glasgow, M.S., 1964-1987  
 \* Earl Gullledge, Ph.D., 1971-1984  
 \* Dorothy P. Harris, M.A., 1970-1991  
 Lewis Heckroth, B.A., M.S., 1964-1992  
 Tom Hester, B.S., 1967-1985  
 Rosa N. Hilton, M.A., 1965-1986  
 Elizabeth Jones Hoefflin, M.S.L.S., 1968-1978  
 Rietta Howard, A.B., M.A., 1968-1992  
 Myron Howell, B.S.E., M.Ed., 1968-1993  
 Dorothy Jackson, M.B.E., 1969-1991  
 Chilton Jensen, M.S., 1968-1976  
 Cecil Johnson, M.S., 1965-1985  
 \* Wesley Johnstone, B.S., 1984-1991  
 Martha C. Jordan, B.A., M.S., 1967-1993  
 Donald Kampwerth, B.S., M.S., 1980-1993  
 Victoria Keller, 1964-1994  
 Sybil King, 1980-1990  
 \* James LaRoche, M.A., 1968-1983  
 R. D. Lawson, M.S., 1970-1985  
 Lionel O. Leon, Jr., B.S., M.S., Ed.D., 1965-1993  
 Elizabeth Martin, M.A., 1965-1987

Maurice Mettee, 1968-1982  
 George Muhlbach, M.A., 1969-1984  
 Albert Nudo, M.M., 1968-1985  
 \* Alfred S. Pell, B.S., 1977-1987  
 Fred Phillips, 1973-1981  
 \* Laura N. Ray, M.A. L.S., 1965-1979  
 \* James Rhoades, M.S., 1967-1990  
 William S. Roberts, B.S., M.S., 1964-1993  
 Ray H. Rudolph, M.B.A., 1965-1984  
 \* William T. Sadler, Ph.D., 1972-1985  
 Jean Sheppard, Ed.S., 1972-1989  
 Naomi Shermer, R.N., 1971-1992  
 Bernice Shuler, M.S. L.S., 1969-1984  
 Olivia Simmons, A.A., B.S., M.S., 1965-1993  
 John W. Stair, B.S., M.S., 1965-1994  
 Marty Steinberg, B.S., 1978-1992  
 Merrill A. Symonds, Ph.D., 1967-1984  
 Mimiruth Walter, M.Ed., 1964-1974  
 J. Richard Warren, B.A., M.A., Ph.D., 1973-1993  
 Lucy Warren, M.L.S., 1971-1990  
 Eugenie Weathers, 1975-1994  
 C. Duque Wilson, B.A.E., M.Ed., 1964-1991  
 Robert D. Wilson, Ph.D., 1970-1991  
 William H. Wise, Sr., B.S., M.B.A., 1977-1991

## **HONORARY CHAIRS**

\* Capp, Al  
 American Arts Chair — Artist-in-Residence, 1966  
 \* Carter, Hodding  
 American Arts Chair — Artist-in-Residence, 1966  
 \* Holzhauser, Emil  
 Honorary Chair in the Arts  
 Myers, Gordon  
 American Arts Chair — Artist-in-Residence, 1966  
 Schrader, Arthur  
 American Arts Chair — Artist-in-Residence, 1966  
 Sikes, Robert L. F.  
 Honorary Chair in Government

\* deceased



# LOCATION OF COURSE PREFIX BY DEPARTMENT

Course Prefix	Department	Course Prefix	Department	Course Prefix	Department
ACG	Business	EME	Business	MGF	Mathematics
ACR	Manufacturing & Technology	EMS	Physical Education	MKA	Business
AER	Manufacturing & Technology	EMT	Public Safety	MNA	Business
AMH	Social Science	ENG	Communications	MTB	Business/Mathematics
ANT	Social Science	ENL	Communications	MTR	Manufacturing & Technology
ARC	Manufacturing & Technology	EST	Manufacturing & Technology	MUH	Humanities and the Arts
ARH	HA Epp.-Com.	ETD	Manufacturing & Technology	MUT	Humanities and the Arts
ART	HA Epp.-Com.	ETI	Manufacturing & Technology	OCE	Physical Sciences
ATM	Manufacturing & Technology	FAD	Human Development & Continuing Education	OST	Business
BAN	Business	FFP	Public Safety	PCB	Biology
BCN	Manufacturing & Technology	FRE	Communications	PEL	Physical Education
BOT	Biology	FRW	Communications	PEM	Physical Education
BSC	Biology	FSS	Business	PEN	Physical Education
BUL	Business	GEB	Business	PEO	Physical Education
CCJ	Public Safety	GER	Communications	PET	Physical Education
CET	Public Safety	GEW	Communications	PHI	Humanities and the Arts
CGS	Business	GLY	Physical Science	PHY	Physical Science
CHD	Human Development & Continuing Education	GRA	Manufacturing & Technology	PMT	Public Safety
CHM	Physical Science	HFT	Business	POS	Social Science
CIS	Business	HHH	Human Development & Continuing Education	POT	Social Science
CJD	Public Safety	HME	Human Development & Continuing Education	PSC	Physical Science
CJT	Public Safety	HOE	Human Development & Continuing Education	PSY	Social Science
CLP	Social Science	HSC	Physical Education	REA	Communications
COA	Human Development & Continuing Education	HUM	Humanities and the Arts	REE	Business
COC	Business	HUN	Biology	REL	Communications
COP	Business	INR	Social Science	SLS	Communications/Business
CTE	Human Development & Continuing Education	JOU	Communications		Human Development & Continuing Education
DAA	Physical Education	LIN	Communications	SPC	Communications
DEP	Social Science	LIS	Communications	SPN	Communications
ECO	Business	LIT	Communications	SPW	Communications
EDF	Communications	MAC	Mathematics	STA	Mathematics
EDP	Social Science	MAN	Business	SYG	Social Science
EET	Manufacturing & Technology	MAP	Mathematics	TAR	Manufacturing & Technology
EEX	Social Science	MAS	Mathematics	TAX	Business
EGS	Manufacturing & Technology	MAT	Mathematics	THE	Humanities and the Arts
		MCB	Biology	TPA	Humanities and the Arts
		MET	Physical Science	TPP	Humanities and the Arts
				WOH	Social Science
				XXX	All departments (noncollege credit)
				ZOO	Biology

# NICEVILLE CAMPUS

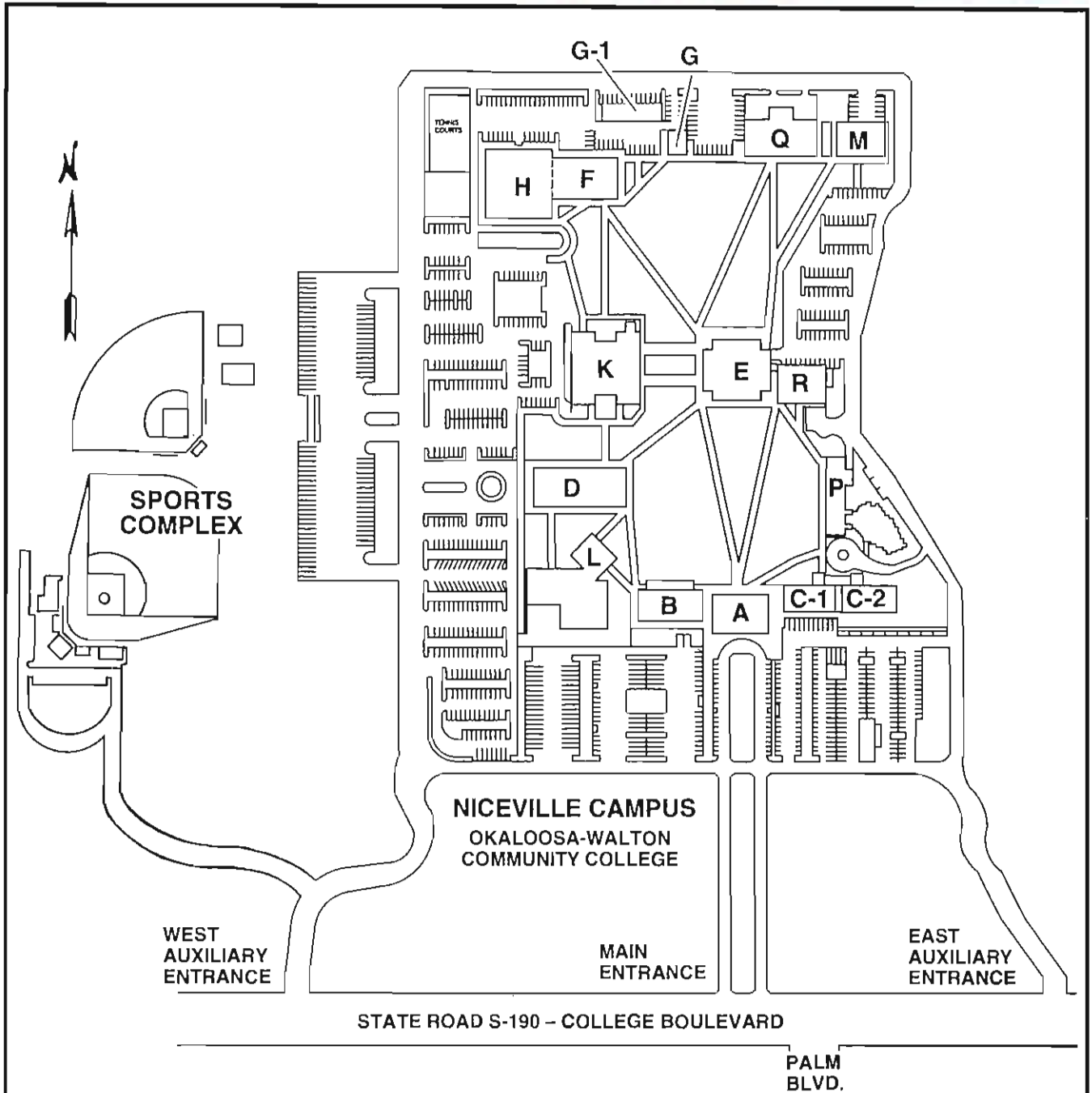

## KEY

Administration.....	A	Maintenance/Receiving .....	G-1
Technical Laboratories .....	B	Gymnasium .....	H
Business .....	C-2	College Mall.....	K
Student Services .....	C-1	Math/Public Safety.....	L
Science.....	D	Visual Arts .....	M
Learning Resources Center.....	E	Continuing Education .....	P
Physical Education .....	F	Industrial Shops.....	Q
Utilities.....	G	Computer Services.....	R

# FORT WALTON BEACH CAMPUS

## OWCC/UWF FORT WALTON BEACH CAMPUS

1170 Martin Luther King Jr. Blvd.

Ft. Walton Beach, FL 32547

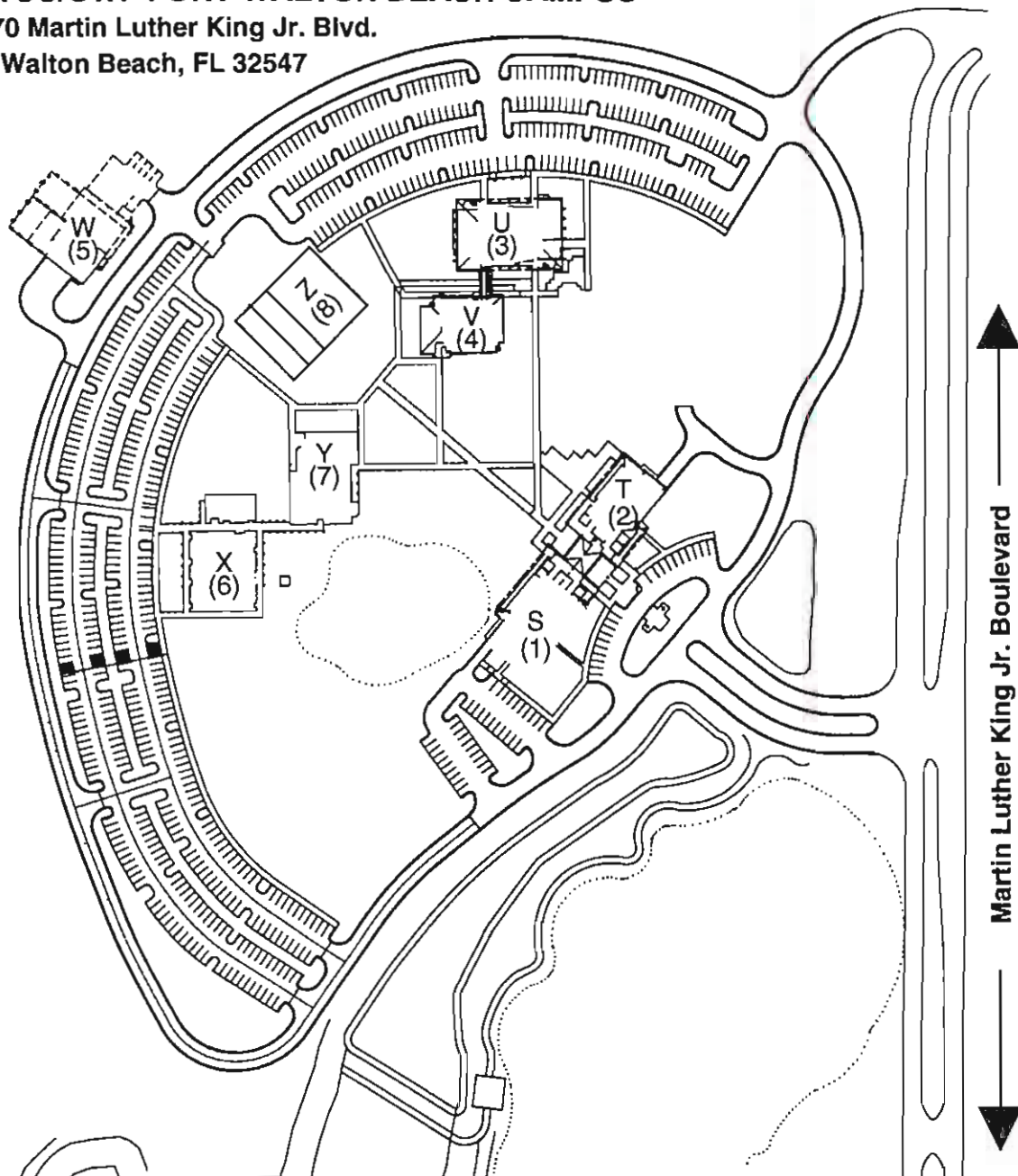

### KEY

- S (Building 1) = Administration Building
- T (Building 2) = Student Services
- U (Building 3) = Classroom Building A
- V (Building 4) = Faculty Offices/Classroom Building B
- W (Building 5) = Utility Services Building
- X (Building 6) = Science Building
- Y (Building 7) = Technology Building
- Z (Building 8) = Library, Fitness Center, Auditorium

# EGLIN AIR FORCE BASE CENTER

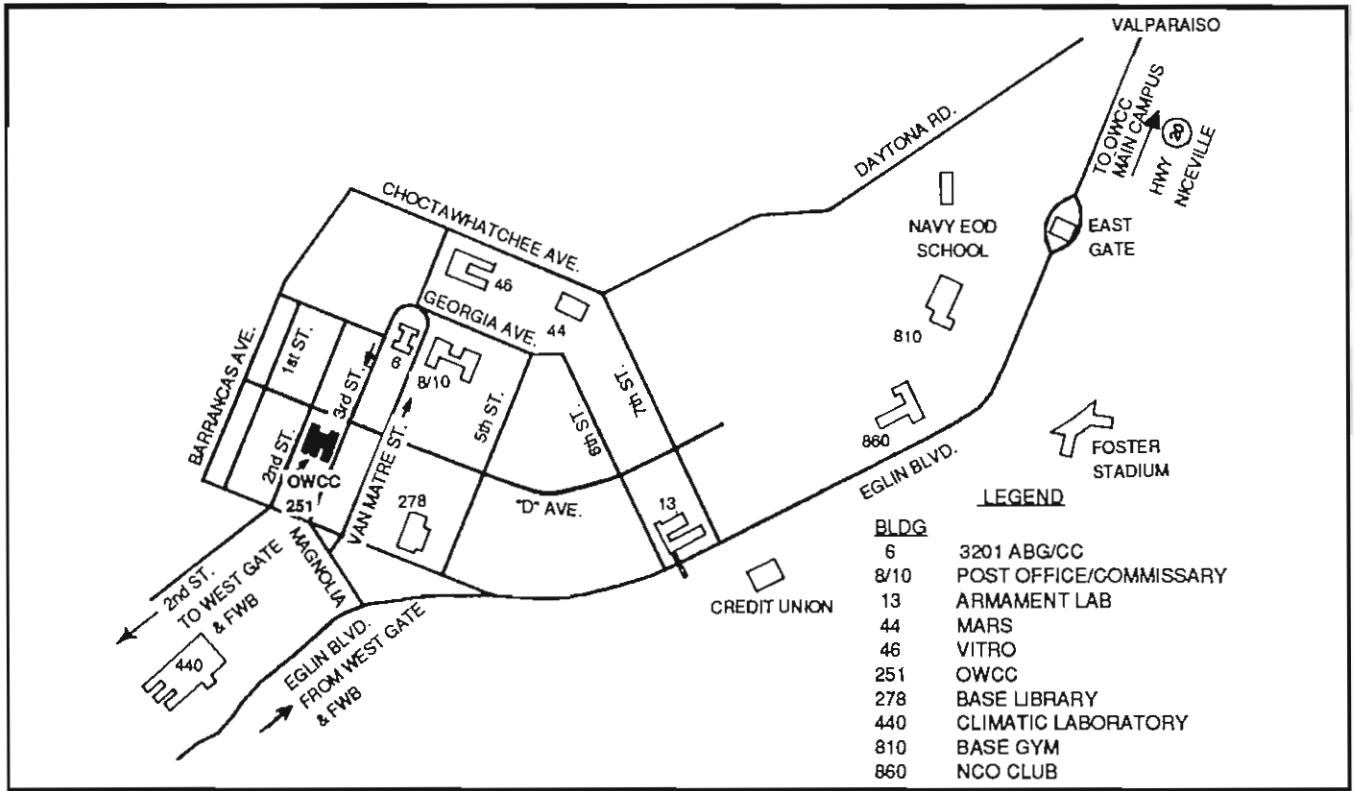

# HURLBURT FIELD CENTER

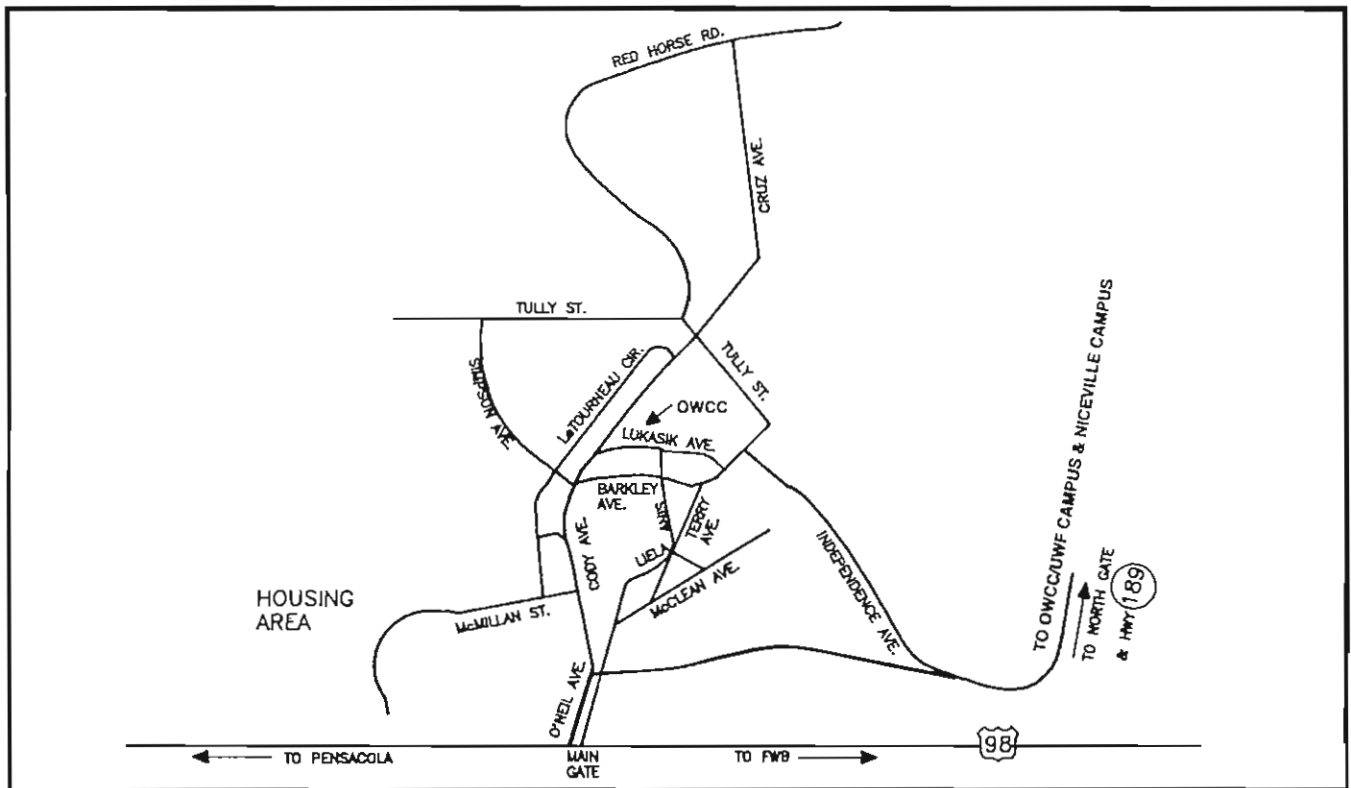

# CHAUTAUQUA CENTER

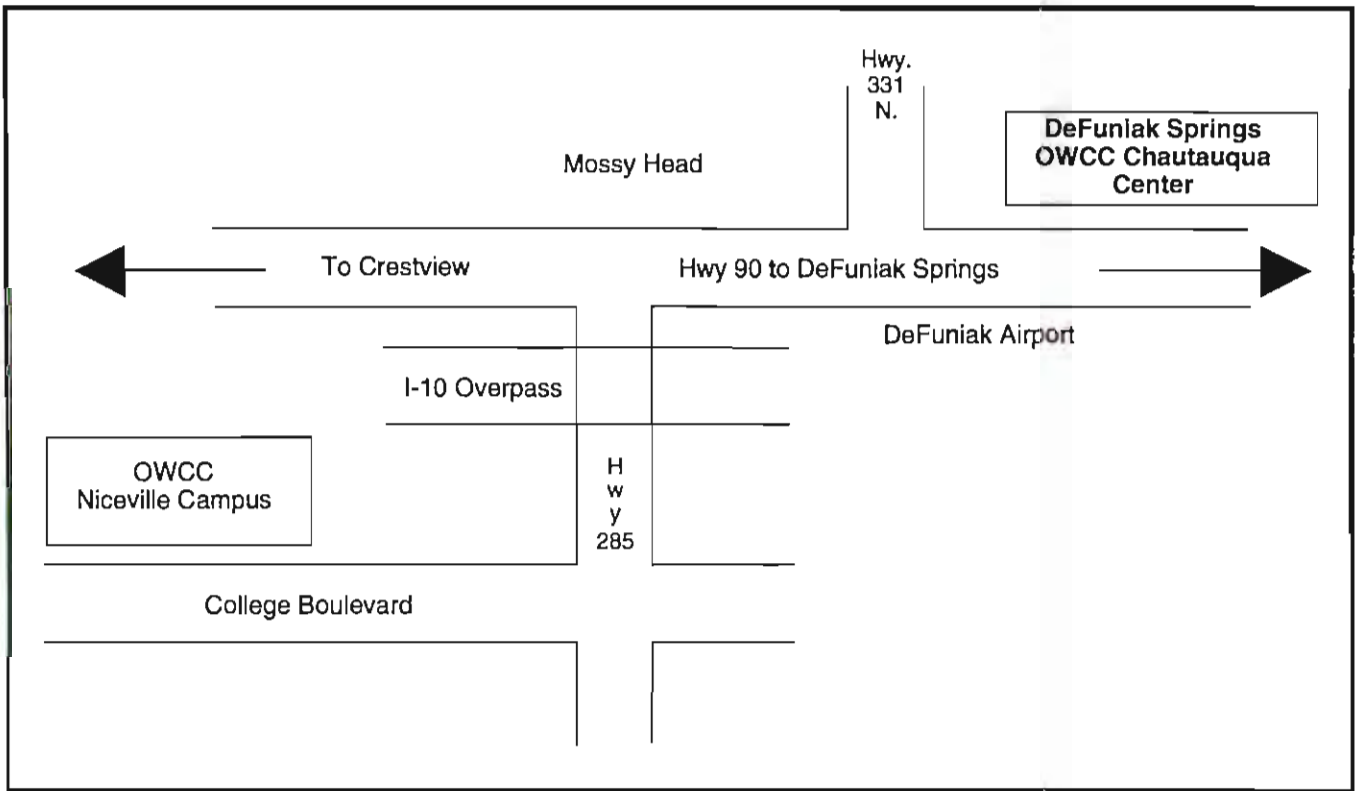

# ROBERT L.F. SIKES EDUCATION CENTER

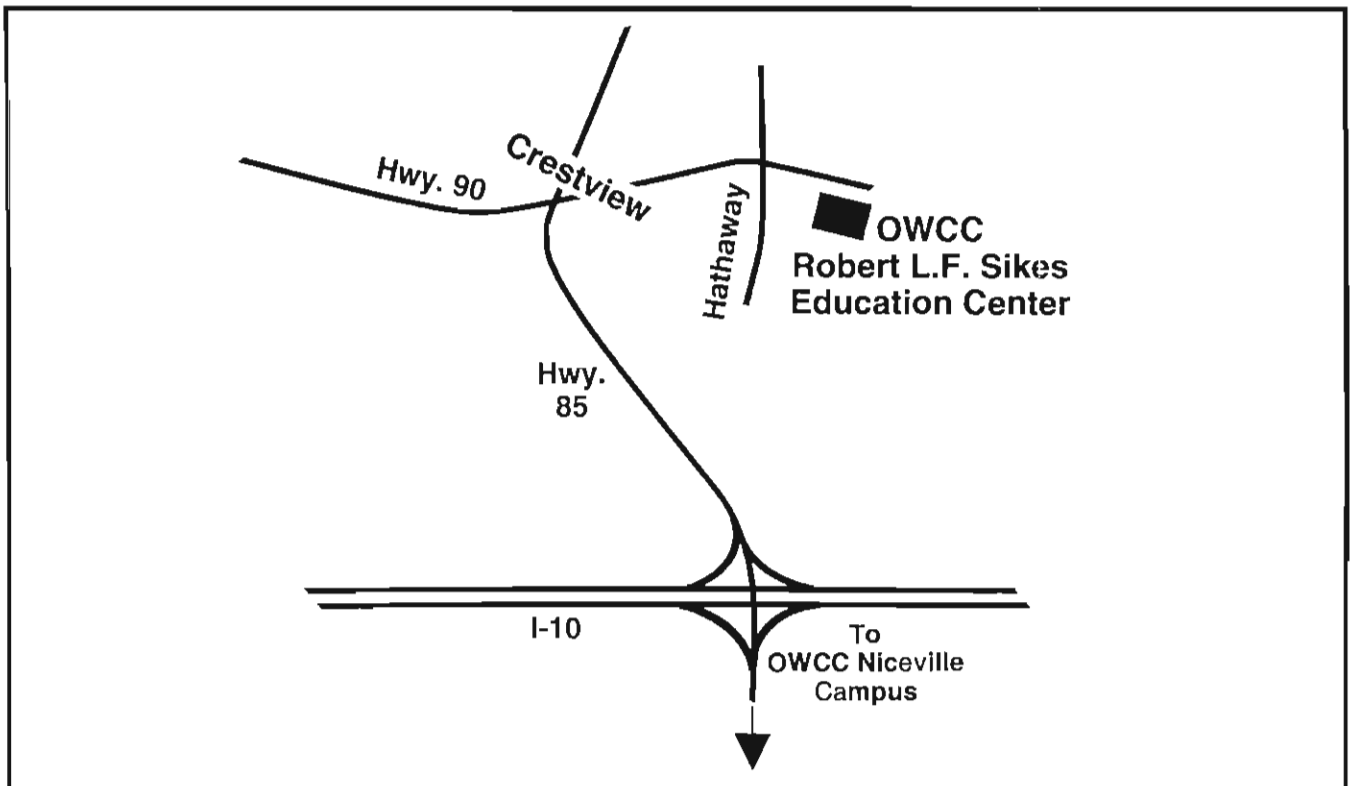



# REQUEST FOR INFORMATION

\_\_\_\_\_ (Date)

Director of Admissions  
Okaloosa-Walton Community College  
Niceville, Florida 32578

Please forward application forms to me for admission to Okaloosa-Walton Community College. The following information will indicate my interests and my stage of educational development.

1. I have (check the highest level which applies):

- completed junior high/middle school
- received a state high school equivalency diploma
- graduated from high school
- completed some college studies
- received a bachelor's degree
- completed some graduate studies
- received a graduate degree

2. I would like to enroll as a:

- Full-time student
- Part-time student

3. My interest is the following kind of studies: \_\_\_\_\_  
\_\_\_\_\_  
\_\_\_\_\_  
\_\_\_\_\_

Name \_\_\_\_\_

Address \_\_\_\_\_  
(Street or P.O. Box) (City State Zip)

Signature \_\_\_\_\_

(Please tear out and fold this page for mailing)

PLACE  
POSTAGE  
HERE

**ADMISSIONS OFFICE**  
**OKALOOSA-WALTON COMMUNITY COLLEGE**  
100 College Boulevard  
Niceville, Florida 32578-1294

**Fold**  
**Here**

---

**(STAPLE OR TAPE HERE)**





# NOTES

# NOTES



# OKALOOSA-WALTON COMMUNITY COLLEGE

100 College Boulevard  
Niceville, FL 32578-1294  
(904) 678-5111



**SUCCESS BY DEGREES**